



Brass, Composite and Thermoplastic Fittings and Valves

Catalog 3501E USA | February 2019



ENGINEERING YOUR SUCCESS.



OTSEGO, MICHIGAN



TIJUANA, MEXICO



ALBION, INDIANA



LAKEVIEW, MICHIGAN



KENT, OHIO



MESA, ARIZONA

⚠ WARNING – USER RESPONSIBILITY

FAILURE OR IMPROPER SELECTION OR IMPROPER USE OF THE PRODUCTS DESCRIBED HEREIN OR RELATED ITEMS CAN CAUSE DEATH, PERSONAL INJURY AND PROPERTY DAMAGE.

This document and other information from Parker-Hannifin Corporation, its subsidiaries and authorized distributors provide product or system options for further investigation by users having technical expertise.

The user, through its own analysis and testing, is solely responsible for making the final selection of the system and components and assuring that all performance, endurance, maintenance, safety and warning requirements of the application are met. The user must analyze all aspects of the application, follow applicable industry standards, and follow the information concerning the product in the current product catalog and in any other materials provided from Parker or its subsidiaries or authorized distributors.

To the extent that Parker or its subsidiaries or authorized distributors provide component or system options based upon data or specifications provided by the user, the user is responsible for determining that such data and specifications are suitable and sufficient for all applications and reasonably foreseeable uses of the components or systems.

Offer of Sale

The items described in this document are hereby offered for sale by Parker Hannifin Corporation, its subsidiaries or its authorized distributors. This offer and its acceptance are governed by the provisions stated on the separate page of this document entitled "Offer of Sale".

Safe Drinking Water Act

In accordance with 42 USC § 300g-6, parts in this catalog are to be used exclusively for nonpotable services such as manufacturing, industrial processing, irrigation, outdoor watering, or any other uses where the water is not anticipated to be used for human consumption. The only exceptions are parts described explicitly as "low lead" or suitable for potable water.

Directives and Regulations

Parker complies with the directives and regulations listed below and goes beyond its statutory obligations for the ranges in question.



D.O.T. FMVSS 571.106
Fittings comply with the performance requirements



European RoHS directives: 2015/863
Relating to the limitation of the use of 10 hazardous substances in electrical and electronic equipment (Lead, Mercury, Cadmium, Hexavalent Chromium, PBB, PBDE, Bis Phthalate, BBP, DBP, DIBP).



Fittings meet the requirements of the specific SAE standard called out in the product sections



CFR 21: Code of Federal Regulation Title 21: Food and Drugs
This code consists of lists of prohibited substances for materials intended to come into contact with foodstuffs.



DIN 74324
Fittings comply with the performance requirements



Regulation 1935/2004
This framework regulation relates to materials and objects designed to come into contact with foodstuffs. It describes specific measures per product group (Art. 5).



Fittings are listed under 1 of 3 categories depending on the application. Fittings meet dimensional and testing requirements as specified by Underwriter Laboratories and carry the UL symbol.



NSF 51: NSF / ANSI-51
Fittings and tubes complying with this standard are tested and approved by NSF for contact with drinks and foodstuffs.



ISO 6149-3
Fittings meet the dimensional requirements



NSF 61: NSF / ANSI-61
Fittings and tubes complying with this standard are tested and approved by NSF for contact with drinking water.



Gold Seal Program
Fittings comply with the ANSI standards and approved by WQA for contact with drinks and foodstuffs.



NSF 42 and 58: NSF/ANSI-42/58
Tubes complying with this standard are tested and approved by NSF for drinking water treatment systems.



REACH regulation: no. 1907/2006
As product manufacturer, we are subject to article 33 of the regulation which defines a duty to inform when a candidate substance is present at more than 0.1% weight for weight.



WRAS: Water Regulations Advisory Scheme
(UK) Fittings approved by this programme are declared compliant for water supply by WRc - NSF.



WHAT DOWNTIME?



THE QUALITY OF YOUR CONNECTORS MAKES A DIFFERENCE

When a line or machine stops due to a defective part, the cost of the downtime is greater than the cost of all the connectors. That's why we guarantee the quality and traceability of every connector we sell. And why our products meet or exceed both national and international standards.

It's what keeps your employees safe, your lines and machines running, and your productivity high.



REACH ✓

FDA



RoHS
2002/95/EC

CE

NSF

DIN



ISO

SAE



UL

WRAS
APPROVED
PRODUCT



WARNING These products can expose you to chemicals including NICKEL, CARBON BLACK, TITANIUM DIOXIDE, or LEAD, which are known to the state of California to cause cancer, and LEAD which is known to cause birth defects or other reproductive harm. For more information go to www.P65Warnings.ca.gov.

WHY PARKER

FOR FLUID SYSTEM CONNECTORS

More Selection



More Materials

Materials suited to your application, including plastic, composite, brass, stainless steel, and plated brass.

More Connector Styles

Choose from push-to-connect, compression, barbed, flare, and pipe fittings, as well as flow controls, ball valves, angle stops, manifolds, and cartridges in both inch and metric sizes from 1/8" to 1-1/2".

Customized Solutions

Don't be boxed in by conventional thinking or the conventional parts that go with it. Whether you need a valve, fitting or manifold, we can produce it in any quantity or configuration, with any connector end.

For prototypes, one-of-a-kind pieces, and emergency repair parts to small or large production runs, our customized solutions can reduce lead times as well as the price of lower-volume components. Three of our locations now specialize in non-standard service, ensuring you get what you need ASAP. Plus they comply with SAE, ISO, DIN, JIS, ASTM, and MIL standards.



WARNING These products can expose you to chemicals including NICKEL, CARBON BLACK, TITANIUM DIOXIDE, or LEAD, which are known to the state of California to cause cancer, and LEAD which is known to cause birth defects or other reproductive harm. For more information go to www.P65Warnings.ca.gov.

Lower Overall Product Cost

Due to tested and approved products with longer life

Find Your Fittings Solution. Fast.

The FittingFinder app helps identify replacement fittings, pull specs and dimensions, locate nearby distributors and more.



The Power of Partnership

13,000

distributors, sales offices, and MRO outlets – instant access to parts, products, maintenance, service, and solutions.

THE PARKER BINS PROGRAM



A line of bins and cabinets used for bin fill placements at OEM and MRO accounts. Sizes and styles range from scoop boxes to open bins and a rolling pneumatic cabinet for storage flexibility. Bins provide increased visibility of Parker products and centralize all fittings needed in one location. When paired with Parker's Bin Labeling Program, distributors can offer customers the benefits of simple part identification and easy restocking.



Reliable System Solutions

Fittings, valves, and manifolds engineered to work together to provide easy-to-assemble, leak-free connections.

Reduced Time to Market



Our ability to design, prototype, and manufacture world-wide will shorten your design cycle, improve production efficiency, and simplify procurement procedures.

Global and Local Support

Your language, your time zone, your currency. No matter where you develop, assemble, manufacture or install, Parker is there.



WARNING These products can expose you to chemicals including NICKEL, CARBON BLACK, TITANIUM DIOXIDE, or LEAD, which are known to the state of California to cause cancer, and LEAD which is known to cause birth defects or other reproductive harm. For more information go to www.P65Warnings.ca.gov.

WHY PARKER FOR FLUID SYSTEM CONNECTORS



EDI Transmission

Computerized data exchange to increase productivity and speed communication.



Improved Stock Management

Packaging, barcodes, and customized labels according to your needs.



E-Catalog

Integration of our product data into your information systems (e-procurement, e-commerce site, etc.)

Communication Tools

We can provide you with any promotional sales material you might need, from brochures and flash animations to sample kits.



PRODUCTS FOR NEWLY MANDATED POTABLE WATER SYSTEMS

Effective on January 4, 2014, amendments to the Safe Drinking Water Act (42 USC § 300g-6) now limit the lead content of components installed in potable water systems to 0.25% weighted average. Potable water systems are systems that provide water suitable for human ingestion i.e., drinking, food preparation, dishwashing, and maintaining oral hygiene.

The good news? Our LIQUIfit™ and TrueSeal™ fittings, valves, angle stops, and cartridges are already NSF and FDA approved and conform to the new “lead free” standard. In addition, we offer pipe and compression products in “lead free” brass and can quote “lead free” fittings as a special.



WARNING These products can expose you to chemicals including NICKEL, CARBON BLACK, TITANIUM DIOXIDE, or LEAD, which are known to the state of California to cause cancer, and LEAD which is known to cause birth defects or other reproductive harm. For more information go to www.P65Warnings.ca.gov.

ParkerStores

Around the corner and around the world, ParkerStores meet customer needs to stay productive by providing the broadest range of products and service choices. Whether for individual parts or entire system solutions, the professionals at the ParkerStore are here to help. Visit us online at www.parkerstore.com.

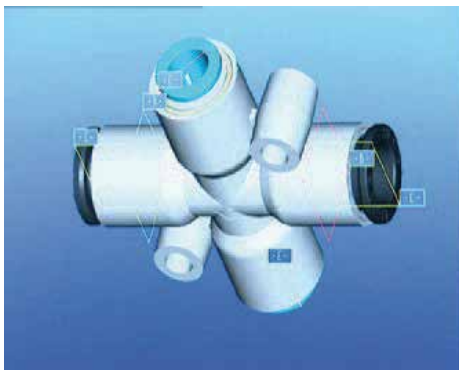

CAD Library

Available online at www.parker.com. Dimensional drawings of every product in various industry formats to help in the design process.



P-Tech

Through education and technical training on FCG products and safe practices, the Parker Training and Certification (P-TAC) program is designed to improve the professionalism and technical skills of participating distributors and Parker employees.



Kitting

Multiple components in a customized kit with a single part number for easier order processing and assembly.



MEETING STRINGENT SANITARY AND ASEPTIC STANDARDS IN FOOD PROCESSING AND PACKAGING

Connecting you to reduced downtime, increased
throughput, and lower maintenance costs

Market research firm RTS Resource says natural highs, one-step convenience, foraged ingredients, flavor-full benefits, and next generation proteins are the five key food and drink trends to watch in the future.

Innova Market Insights has also highlighted the key issues of reducing waste and regaining consumer trust as top food industry trends to look out for. Plus the need for food safety will remain paramount.



WARNING These products can expose you to NICKEL (Metallic), CARBON BLACK (airborne, unbound particles of respirable size), TITANIUM DIOXIDE (airborne, unbound particles of respirable size), and LEAD, which is known to the state of California to cause cancer and birth defects or other reproductive harm.

FOOD PROCESSING AND PACKAGING

APPLICATIONS

Mixing | Baking | Cooling | Packaging | Filling | Washing | Labeling | Conveying

PERFORMANCE EXPECTATIONS

- FDA compliance
- Hygienic design
- Compact
- Highly reliable
- Ability to work in a vacuum
- Wide range of chemical compatibility
- Ability to withstand high temperatures
- Detectability



APPLICABLE PRODUCTS

Prestolok® PLM Metal Fittings

Prestolok® PLS Stainless Steel Fittings

LIQUIfit™ Fittings

Flow Controls

Stainless Steel Flow Controls



ENGINEERING DURABILITY

Withstanding harsh washdown chemicals



Situation: A food processing equipment manufacturer was receiving customer complaints about fittings that degraded when exposed to harsh washdown chemicals in food processing plants.

Solution: Parker's Prestolok® Composite fittings. Manufactured from an engineered grade of glass-filled nylon, the fittings withstood exposure to the aggressive washdown chemicals. Additionally, the compact fittings, available in a wide variety of configurations, maintained full airflow throughout the system, which allowed the equipment designers to optimize the routings.

Benefits: Reduced warranty service • Reduced component quantity • Reduced energy consumption due to full-flow design



WARNING These products can expose you to chemicals including NICKEL, CARBON BLACK, TITANIUM DIOXIDE, or LEAD, which are known to the state of California to cause cancer, and LEAD which is known to cause birth defects or other reproductive harm. For more information go to www.P65Warnings.ca.gov.



COLLABORATING FOR LEAK-FREE INNOVATION IN LIFE SCIENCE

Connecting you to higher productivity,
increased efficiency, and faster assembly



According to Deloitte, a changing health care landscape, expiring patents, generic competition, pricing pressures, heightened regulatory scrutiny, expansion into emerging markets, increasing alliances and acquisitions, and a persistent economic slowdown are prompting global life sciences companies to adopt new business models designed to counter slowing sales growth and declining profitability, deliver better patient outcomes at lower cost, and position them for success.



WARNING These products can expose you to NICKEL (Metallic), CARBON BLACK (airborne, unbound particles of respirable size), TITANIUM DIOXIDE (airborne, unbound particles of respirable size), and LEAD, which is known to the state of California to cause cancer and birth defects or other reproductive harm.

APPLICATIONS

Oxygen Transfer | Fluid Transfer | Dispensing | Cleaning and Sterilization | Pneumatic Circuits



PERFORMANCE EXPECTATIONS

- Quality traceability
- Cleanliness
- Compact design
- Suitable for use with O₂
- High reliability
- Installation flexibility

APPLICABLE PRODUCTS

Prestolok® PLM Metal Fittings

Prestolok® PLS Stainless Steel Fittings

LIQUIfit™ Fittings

Stainless Steel Flow Controls



ENGINEERING INTEGRATED ASSEMBLIES

Single-piece solution simplifies, speeds, and economizes



Situation: A major medical OEM was using a very labor-intensive, six-step assembly process for an oxygen service connection.

Solution: Working with a distributor, Parker developed a customized, single-piece filtering cartridge, cleaned for oxygen use. The OEM was able to eliminate five components and five assembly steps, saving \$19.88 per unit. With 3,000 units annually, the OEM was able to reduce total costs by \$59,640.

Benefits: Reduced assembly time and installation labor costs • Reduced type and quantity of components • Reduced potential leak points • Reduced total product costs





IN WATER AND BEVERAGE: KEEPING IT CLEAN, KEEPING IT SAFE

Connecting you to leak-free innovation,
smaller footprints, and faster assembly



According to Innova Market Insights, now is the time for the small innovator who develops a distinct product. These products' small-scale appeal will be accompanied by big trend potential accelerated by social media platforms. A more holistic approach to nutritious beverage solutions is another trend. These "well drink" trends will include more function in functional beverages, better sweetened drinks, and healthy alcohol-based beverages.

APPLICATIONS

Filtration | Purification | Processing | Dispensing | Bottling | Treatment | Aeroionics

PERFORMANCE EXPECTATIONS

- Manufactured from FDA-compliant materials
- Meet NSF-61 requirements for potable water contact
- Excellent chemical resistance
- Wide range of fluid compatibility
- Mechanical resistance
- Installation flexibility



DID YOU KNOW?

Parker's entire TrueSeal™ line is now available in Kynar. A fluorocarbon with excellent chemical and abrasion resistance, mechanical strength, and dielectric properties, Kynar is an excellent choice for high purity water.

APPLICABLE PRODUCTS

Check Valves

LIQUIfit™ Fittings

LIQUIfit™ Ball Valves

TrueSeal™ Thermoplastic Fittings

TrueSeal™ Ball Valves

Low Lead Fittings



NEW LOW LEAD AMENDMENT

What it means for you



Effective January 4, 2014, all products in contact with drinking water were limited to a maximum lead content of 0.25% for all wetted components. The new rule, which mostly replicated California's regulation governing lead in drinking water, impacts virtually every component of a water treatment and distribution system, as well as services and applications that provide water suitable for human ingestion (think food preparation, beverage manufacturing, and dishwashing, for example).

Products excluded from the lead rule include those used exclusively for non-potable services such as manufacturing, industrial processing, and irrigation. Leaded components already in use by the January 4th deadline are grandfathered in. Repairs can be made in place, but once a leaded component is removed for any reason, it must be replaced with a lead-free component.

Parker Fluid System Connectors is committed to growing its "lead free" product offerings in both brass and polymer product ranges. Our existing low lead products - LIQUIfit™, TrueSeal™, and Green Brass - are available in a range of styles and are:

- Suitable for high-pressure brewing and dispensing at temperatures up to 400°F
- Flavor-neutral
- Designed for harsh commercial environments
- More cost effective than other metals, including stainless steel
- American-made



WARNING These products can expose you to chemicals including NICKEL, CARBON BLACK, TITANIUM DIOXIDE, or LEAD, which are known to the state of California to cause cancer, and LEAD which is known to cause birth defects or other reproductive harm. For more information go to www.P65Warnings.ca.gov.



IMPROVING DURABILITY, LESSENING RISK IN PETROCHEMICAL MANUFACTURING

Connecting you to higher productivity,
faster assembly, and leak-free innovation

The Institute for Trend Research predicted 2014 would be a growth year for North American petrochemical manufacturers. Abundant gas, tight oil, and potential energy self-sufficiency would spur investments in the U.S. and Canada. Overseas opportunities from emerging countries would also increase. This very strong growth is predicted to continue the following year. As a result, companies should focus now on cutting costs, right-sizing, creating new products, and hiring good people to take advantage of the upswing.

PETROCHEMICAL MANUFACTURING

APPLICATIONS

Processing | Transferring | Pneumatic Circuits | Cooling | Measuring



PERFORMANCE EXPECTATIONS

- High chemical resistance
- Robust design
- Excellent chemical compatibility
- Wide temperature range
- Quality traceability

CASE STUDY:

TrueSeal™ Kynar® Thermoplastic Fittings



Polyvinylidene fluoride, or PVDF – also known as Kynar – is a fluorocarbon that has excellent abrasion resistance, dielectric properties, and mechanical strength. In the area of chemical compatibility, Kynar is highly resistant to wet or dry chlorine, bromine, and other halogens, alcohols, strong acids, aliphatics, aromatics, and chlorinated solvents.

That makes our TrueSeal Kynar fittings an excellent choice for chemical processing, as well as manufacturing involving exposure to chlorine, solvents, and UV-sensitive chemicals.

APPLICABLE PRODUCTS

- Prestolok® PLM Metal Fittings
- Prestolok® PLS Stainless Steel Fittings
- Prestolok® PLP Metal Fittings
- Stainless Steel Check Valves
- Stainless Steel Flow Controls
- TrueSeal™ Kynar® Fittings



Kynar® is a registered trademark of Arkema Group.



INCREASING PERFORMANCE, STANDARDIZING INVENTORY IN FACTORY / PROCESS AUTOMATION

Connecting you to increased efficiency, improved
throughput, and bottom line benefits



According to IMS research, the global industrial automation market will profit from improved economies worldwide. Frost and Sullivan predicts factories will utilize cloud computing, cyber security and mobile communication technologies to evolve into information and data hubs providing interaction between the factory floor and the enterprise across all end users. Asset management and flexible manufacturing will also play a role in driving factory-enterprise integration.

FACTORY / PROCESS AUTOMATION

APPLICATIONS

Processing | Transferring | Pneumatic Circuits | Cooling | Measuring

ENGINEERING PRODUCTION THROUGHPUT

Higher flow and more accurate speed control enhance process automation for a faster production rate



Situation: A food packaging integrator built a custom piece of equipment to transfer uncooked product in and out of curing ovens. The rodless cylinder used to shuttle racks from the conveyor into the ovens was not moving fast enough to keep up with the anticipated production rate.

Solution: Parker replaced the rodless cylinder with a smaller Parker Legris flow control, creating faster rack movement and finer speed adjustment. The advanced flow control is now standard for the company's pneumatic cylinders.

Benefits: Optimal flow • Finer speed adjustment • Enhanced production rate



PERFORMANCE EXPECTATIONS

- Compact design
- Weld spatter resistance
- Robustness
- Vacuum performance
- High reliability
- Mechanical resistance
- Installation flexibility

APPLICABLE PRODUCTS

Prestolok® PLP Metal Fittings
Prestolok® PLP Composite Fittings
Prestolok® PLM Metal Fittings
Flow Controls



WARNING These products can expose you to chemicals including NICKEL, CARBON BLACK, TITANIUM DIOXIDE, or LEAD, which are known to the state of California to cause cancer, and LEAD which is known to cause birth defects or other reproductive harm. For more information go to www.P65Warnings.ca.gov.



IN TRANSPORTATION, GLOBAL LOGISTICS AND VENDOR PARTNERSHIPS

Connecting you to higher productivity, increased efficiencies, and improved inventory management

Industry experts see growth for the U.S. in most modes of transportation, particularly truck, rail, and intermodal. With the global economy still on the mend, trade is predicted to grow at a modest 3-4% as developed nations contend with weak growth, eurozone debt, a slowdown in China as well as other emerging economies, and unpredictable oil prices. Concern over environmental issues will continue, spurring biofuels and hybrid vehicles. The need for global system solution partners will remain strong.



WARNING These products can expose you to NICKEL (Metallic), CARBON BLACK (airborne, unbound particles of respirable size), TITANIUM DIOXIDE (airborne, unbound particles of respirable size), and LEAD, which is known to the state of California to cause cancer and birth defects or other reproductive harm.

APPLICATIONS

Air Brakes | Cab Controls | Fuel System | Engine | Transmission | Cooling | Air Tanks



PERFORMANCE EXPECTATIONS

- Compact design
- Impact resistant
- Meets DOT and SAE requirements
- Robustness
- Vibration resistance
- High reliability
- High temperature resistance
- Installation flexibility

APPLICABLE PRODUCTS

Prestomatic Fittings
PTC Fittings
Prestomatic Cartridges
Manifolds
NTA Fittings

Transmission Fittings
Vibra-Lok Fittings
Truck Valves
Lanyard Valve



ENGINEERING AN INNOVATIVE SOLUTION QUICKLY
SLA model confirms solution design and fit, saves time and expense



SITUATION: A major North American truck manufacturer initiated a tubing routing change that required a fitting not currently in stock. To meet the build schedule, the customer needed a production-ready solution in six weeks.

SOLUTION: With the application requirements understood, the Parker team provided a 3D model within two days to confirm the tube connection configurations.

The customer approved the functionality of the design, but still needed to confirm fit in the confined application. In fewer than 10 days, the Parker team provided a stereolithography (SLA) model that confirmed the design's fit. Satisfied with the results, the client authorized the go-ahead to create the final part, meeting his need for a production-ready solution.

BENEFITS: Concept to production in less than five weeks • Reduced prototype costs



Product	Type	Body Material	Temperature		Maximum Pressure		Tubing Size	
			MIN.	MAX.	PSI	BAR	IN.	MM

Pneumatic

Prestolok Metal	Push-to-Connect	Nickel Plated Brass	0	200	300	21	1/8 - 1/2	4 - 14
Prestolok Composite	Push-to-Connect	Glass Filled Nylon	-4	175	290	20	1/8 - 1/2	3 - 14
Prestolok PLM	Push-to-Connect	Nickel Plated Brass	-4	250	290	20	5/32 - 1/2	4 - 14
Prestolok PLS	Push-to-Connect	Stainless Steel	-4	245	290	20	5/32 - 1/2	4 - 12
Flow controls	Function	Nylon/Treated Brass	30	160	145	10	1/8 - 1/2	4 - 14
Blocking Valves	Function	Treated Brass	-4	160	145	10	1/8 - 3/8	4 - 14
Slow Start Valve	Function	Nickel Plated Brass	5	140	150	10	1/4 - 3/8	4 - 6
Threshold Sensor	Function	Polymer	5	140	115	8	5/32	4
Check Valve	Function	Nylon/Nickel Plated Brass	34	150	145	10	5/32 - 3/8	4 - 12

Water & Beverage

LIQUIfit	Push-to-Connect	Bio-based Polymer	35	299	230	16	1/4 - 1/2	4 - 12
TrueSeal Acetal	Push-to-Connect	Acetal	-20° F (-29° C)	+180° F (+85° C)	300	21	1/4 - 1/2	-
TrueSeal Polypropylene	Push-to-Connect	Polypropylene	0° F (-18° C)	+225° F (+110° C)	150	10	1/4 - 1/2	-
TrueSeal Kynar	Push-to-Connect	Kynar	0° F (-18° C)	+275° F (+135° C)	300	21	1/4 - 1/2	-
Fast & Tite Polypropylene	Compression	Polypropylene	0° F (-18° C)	+212° F (+100° C)	300	21	1/4 - 5/8	-
Fast & Tite Nylon	Compression	Nylon	-40° F (-40° C)	+200° F (+93° C)	300	21	1/4 - 5/8	-
Par-Barb Polypropylene	Barb	Polypropylene	+10° F (-12° C)	+220° F (+104° C)	125	9	1/8 - 3/4	-
Par-Barb Nylon	Barb	Nylon	-40° F (-40° C)	+200° F (+93° C)	125	9	1/8 - 1 1/2	-
LIQUIfit Ball Valves	Push-to-Connect	Polypropylene	35° F (1° C)	+200° F (+93° C)	150	10	1/4 - 3/8	-
TrueSeal Ball Valves	Push-to-Connect	Polypropylene	0° F (-18° C)	+225° F (+107° C)	150	10	1/4 - 3/8	-
Par-Barb Ball Valves	Barb	Polypropylene	-40° F (-40° C)	+200° F (+93° C)	150	10	1/4 - 3/8	-
Check Valves	Push-to-Connect	Acetal	+34° F (+1° C)	+150° F (+65° C)	150	10	1/4 - 3/8	-

Cartridges

Carstick	Push-to-Connect	Polymer	-4° F (-20° C)	+175° F (+79° C)	290	20	1/8 - 3/8	4 - 8
PLM/PLS	Push-to-Connect	Brass/ Stainless	-4° F (-20° C)	+175° F (+150° C)	435	30	-	4 - 14
LIQUIfit	Push-to-Connect	Polymer	+ 35° F (+1° C)	+200° F (+93° C)	230	16	1/4 - 1/2	4 - 12
TrueSeal	Push-to-Connect	Acetal	-20° F (-28° C)	+180° F (+82° C)	150	10	1/4 - 1/2	-
SAE Encapsulated	Push-to-Connect	Brass	-40° F (-40° C)	+200° F (+93° C)	250	17	1/4 - 5/8	-

Transportation Push-to-Connect

Prestomatic	Push-to-Connect	Brass	-40° F (-40° C)	+200° F (+93° C)	250	17	5/32 - 3/4	-
PTC Composite	Push-to-Connect	Composite	-40° F (-40° C)	+200° F (+93° C)	250	17	1/4 - 3/4	-
Metric Prestomatic	Push-to-Connect	Brass	-40° F (-40° C)	+200° F (+93° C)	250	17	-	4 - 16

Transportation Compression

NTA	Compression	Brass	-40° F (-40° C)	+200° F (+93° C)	150	10	3/16 - 3/4	-
Transmission	Compression	Brass	-40° F (-40° C)	+220° F (+104° C)	150	10	1/8 - 5/32	-
Air Brake - AB	Compression	Brass	-65° F (-54° C)	+250° F (+121° C)	400	27	1/4 - 3/4	-
Air Brake Hose Ends	Compression	Brass	-50° F (-45° C)	+212° F (+100° C)	225	15	3/8 - 1/2	-
Vibra-Lok Buna N Sleeve	Compression	Brass	-30° F (-34° C)	+275° F (+135° C)	On Condition	On Condition	1/8 - 3/4	-
Vibra-Lok Fluorocarbon Sleeve	Compression	Brass	-15° F (-26° C)	+450° F (+232° C)	On Condition	On Condition	1/8 - 3/4	-
Truck Valves	Shut Off	Brass	-30° F (-34° C)	+250° F (+121° C)	150	10	3/8 - 3/4	-
Lanyard Valve	Manual Release	Brass	-40° F (-40° C)	+200° F (+93° C)	150	10	-	-

WARNING These products can expose you to chemicals including NICKEL, CARBON BLACK, TITANIUM DIOXIDE, or LEAD, which are known to the state of California to cause cancer, and LEAD which is known to cause birth defects or other reproductive harm. For more information go to www.P65Warnings.ca.gov.

Product	Type	Body Material	Temperature		Maximum Pressure		Tubing Size	
			MIN.	MAX.	PSI	BAR	IN.	MM

Transportation Cartridges & Manifolds

SAE Encapsulated Cartridge	Push-to-Connect	Brass	-40° F (-40° C)	+200° F (+93° C)	250	17	5/32 - 3/4	-
Brass Manifold	Pipe	Brass	-65° F (-54° C)	+250° F (+121° C)	1,000	69	-	-
Presto Manifold	Push-to-Connect	Glass Filled Nylon	-40° F (-40° C)	+200° F (+93° C)	150	10	1/4 - 1/2	-

Industrial Compression Style

Compression	Compression	Brass	-65° F (-54° C)	+250° F (+121° C)	400	27	1/8 - 7/8	
Compress-Align	Compression	Brass	-65° F (-54° C)	+250° F (+121° C)	2800	193	1/8 - 1	
Poly-Tite	Compression	Brass	0° F (-18° C)	+150° F (+65° C)	150	10	1/4 - 1/2	
Hi-Duty	Compression	Brass	-65° F (-54° C)	+250° F (+121° C)	4300	296	1/8 - 5/8	

Industrial Flare Fittings

45° Flare	Flare	Brass	-65° F (-54° C)	+250° F (+121° C)	2800	193	1/8 - 7/8	
Inverted Flare	Flare	Brass	-65° F (-54° C)	+250° F (+121° C)	2800	193	1/8 - 3/4	
Access Valves	Flare	Brass	-20° F (-29° C)	+200° F (+93° C)	500	34	1/8 - 1/2	

Industrial Barbed Fittings

Dubl-Barb	Barbed	Brass	-65° F (-54° C)	(1/4-3/8) - +90° F (+32° C) (1/2) - +100° F (+37° C)	(1/4 - 3/8) 150 (1/2) 100	(1/4 - 3/8) 10 (1/2) 7		
Hose Barbs	Barbed	Brass	-40° F (-40° C)	+160° F (+71° C)	150	10	1/4 - 1	

Industrial Adapters

Pipe	Threaded	Brass	-65° F (-54° C)	+250° F (+121° C)	1,000	69	1/8 - 1	
ISO Port Adapters		Brass	Dependent on Tubing or Hose End Connection					
Garden Hose		Brass	+35° F (+2° C)	+100° F (+38° C)	75	5		

 **WARNING** These products can expose you to chemicals including NICKEL, CARBON BLACK, TITANIUM DIOXIDE, or LEAD, which are known to the state of California to cause cancer, and LEAD which is known to cause birth defects or other reproductive harm. For more information go to www.P65Warnings.ca.gov.

Product	Type	Body Material	Temperature		Maximum Pressure		Tubing Size	
			MIN.	MAX.	PSI	BAR	IN.	MM

Industrial Ball Valves

500 Series	Female/Female	Brass	0° F (-18° C)	+350° F (+176° C)	600	41		
501 Series	Female/Male	Brass	0° F (-18° C)	+350° F (+176° C)	600	41		
502 Series	Panel Mounted	Brass	0° F (-18° C)	+350° F (+176° C)	600	41		
506 Series	Straight Thread	Brass	0° F (-18° C)	+350° F (+176° C)	600	41		
509 Series	Solder Ends	Brass						
510 Series	Male/Female Straight Thread	Brass	0° F (-18° C)	+350° F (+176° C)	600	41		
520 Series	Female/Female	Brass	0° F (-18° C)	+350° F (+176° C)	600	41		
533 Series	3-Way Diversion	Brass	-20° F (-29° C)	+350° F (+176° C)	400	27		
540 Series	4-Way	Brass	-20° F (-29° C)	+350° F (+176° C)	400	27		
590/591 Series	Right Angle	Brass	-50° F (-45° C)	+350° F (+176° C)	250	17		
500HB Series	Hose Barb	Brass	0° F (-18° C)	+350° F (+176° C)	150	10		
600 Series	Six Port Diversion	Brass	0° F (-18° C)	+250° F (+121° C)	150	10		
500CS/502CS Series	Female/Female	Carbon Steel	-20° F (-29° C)	+425° F (+218° C)	2,000 (1/4 - 1) 1,500 (1 1/4 - 2)	137 (1/4 - 1) 103 (1 1/4 - 2)		
506CS Series	Straight Thread	Carbon Steel	-20° F (-29° C)	+425° F (+218° C)	3,000	206		
500HP/506HP Series	High Pressure	Carbon Steel	-10° F (-23° C)	+210° F (+99° C)	6,000	413		
501SS	Male/ Female	Stainless Steel	0° F (-18° C)	+400° F (+204° C)	2,000	137		
502SS	Female/Female	Stainless Steel	0° F (-18° C)	+400° F (+204° C)	2,000 (1/4 - 1) 1,500 (1 1/4 - 2)	137 (1/4 - 1) 103 (1 1/4 - 2)		
708 Series	Male/Female	Brass	-35° F (-37° C)	+300° F (+148° C)	500	34		
709 Series	Female/Female	Brass	-35° F (-37° C)	+300° F (+148° C)	500	34		
200 Series	Female/Female	Chrome Plated Brass	0° F (-18° C)	+200° F (+93° C)	200	13		
608 Series	Male/Female	Brass	0° F (-18° C)	+200° F (+93° C)	450	31		
609 Series	Female/Female	Brass	0° F (-18° C)	+200° F (+93° C)	450	31		

Plug Valves

607 Series	Male/Male	Brass	-40° F (-40° C)	+175° F (+79° C)	250	17		
608 Series	Male/Female	Brass	-40° F (-40° C)	+175° F (+79° C)	250	17		
609 Series	Female/Female	Brass	-40° F (-40° C)	+175° F (+79° C)	250	17		

Needle Valves/Drain Cocks/ Ground Plug Shutoff

Needle Valves	Shutoff	Brass	-45° F (-42° C)	+250° F (+121° C)	150	10		
Drain Cocks	External/Internal	Brass	-65° F (-54° C)	+250° F (+121° C)	150	10		
Ground Plug Shutoff	Shutoff	Brass	+32° F (0° C)	+125° F (+51° C)	30	2		

WARNING These products can expose you to chemicals including NICKEL, CARBON BLACK, TITANIUM DIOXIDE, or LEAD, which are known to the state of California to cause cancer, and LEAD which is known to cause birth defects or other reproductive harm. For more information go to www.P65Warnings.ca.gov.



Parker
W55PLP-4-4
MALE ELBOW

Parker
W55PLP-4-4
MALE CONNECTOR

Parker
215PML-2-25
LONG NIPPLE

Parker
215PML-2-25
LONG NIPPLE

Parker
W55PW-4-4
MALE CONNECTOR

Parker
W55PW-4-2
MALE CONNECTOR

Parker
164PLP-4
UNION TEE

Parker
W172PW-4-2
MALE BRANCH TEE

Parker
517P-4
NUT/SPRUE

Parker
517P-4
UNION

Parker
517PW-4
UNION BULKHEAD

Parker
08-4
DUST BOOT

Parker
64C-4-4
MALE CONNECTOR

Parker
64C-4-4
MALE CONNECTOR

Parker
64C-4-2
MALE CONNECTOR



Pneumatic: Push-to-Connect

Section A

Prestolok PLP Push-to-Connect Fittings	Prestolok PLS Stainless Steel Push-to-Connect Fittings
Prestolok PLP Composite Push-to-Connect Fittings	Oscillating Elbows
Prestolok PLM Metal Push-to-Connect Fittings	



Pneumatic: Integrated Fittings

Section B

Compact Flow Controls	Stainless Steel Flow Controls	Quick Exhaust Valve
Miniature Flow Controls	In-Line Check Valves	Blocking Valves
Swivel Outlet Flow Controls	Stainless Steel Check Valves	Slow Start Valves
Plug-In Flow Controls	Piloted Operated Check Valves	Threshold Sensor Fittings
In-Line Flow Controls	Pneumatic Slide Valves	Mini Ball Valves
Metal Flow Controls		



Water & Beverage: Thermoplastic Fittings and Valves

Section C

LIQUIfit Fittings	Fast & Tite® Fittings
TrueSeal™ Fittings	Par-Barb® Fittings



Cartridges

Section D

Cartridges	LIQUIfit® Cartridges	PLM/PLS Cartridges
Carstick® Cartridges	TrueSeal™ Cartridges	PMT Cartridges



Transportation Push-to-Connect

Section E

PTC Composite	Metric Prestomatic Fittings
Prestomatic Fittings	PMH Fittings



Transportation Compression Fittings & Valves

Section F

Air Brake-NTA® Fittings	Air Brake	Truck Valves & Lanyard Valve
Transmission Fittings	Hose Ends Fittings	
Air Brake – AB Fittings	Vibra-Lok Fittings	



Industrial Compression Style Fittings

Section G

Compression Fittings	Brass Metric Compression	Hi-Duty Flareless Tube Fittings
Compress-Align® Fittings	Poly-Tite Fittings	



Industrial Flare Fittings

Section H

45° Flare Fittings	Inverted Flare Fittings	Access Valves
--------------------	-------------------------	---------------

WARNING These products can expose you to chemicals including NICKEL, CARBON BLACK, TITANIUM DIOXIDE, or LEAD, which are known to the state of California to cause cancer, and LEAD which is known to cause birth defects or other reproductive harm. For more information go to www.P65Warnings.ca.gov.

Industrial Barbed Fittings Section I

Dubl-Barb® Fittings	Hose Barb Fittings
---------------------	--------------------



Industrial Adapters Section J

Pipe Fittings	Nickel Plated Metric Adapters	Garden Hose Fittings
Metric Adapters	ISO Port Adapters	



Industrial Valves Section K

Ball Valves Brass Series 500	Ball Valves Stainless Steel Series 502SS
Ball Valves Brass Series 501	Ball Valves Micro Series 708/709
Ball Valves Brass Series 502	Ball Valves Mini Series 200/608/609
Ball Valve Brass Series 506	Ball Valves Polypropylene
Ball Valves Brass Series 509	Plug Valves Series PV
Ball Valves Brass Series 510	Ball Valves Rotary Actuator Series ACT
Ball Valves Brass Series 520	Ball Valve Series BVGC
Ball Valves Brass Series 533	Ball Valve Series BVGL
3-Way Diversion / Series 540 4-Way	Ball Valve Series BVGLOCK
Ball Valves Brass Series 590/591	Ball Valve Series MBVG
Ball Valves Brass Series 500HB	Axial Valves
Ball Valves Brass Series 600	Replacement Componentry
Ball Valves Carbon Steel Series 500CS/502CS	Ball Valve Stem Extensions Series STX
Ball Valves Carbon Steel Series 506CS	Needle Valves
Ball Valves Carbon Steel Series 500HP, 506HP	Drain Cocks/Ground Plug Shutoff
Ball Valves Stainless Steel Series 501SS	



Accessories Section L

Blow Guns	Silencers	Bins, Bags & Copper Tubing
-----------	-----------	----------------------------



Tube Fabricating Equipment Section M

Tube Cutters	Metric Tube Benders	Flaring Tools
Kloskut Tube Cutters	Tube Benders, Spring Type	In-Ex® Tube Deburring Tool
Tube Benders, Lever Type		



General Technical Section N

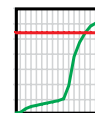

WARNING These products can expose you to chemicals including NICKEL, CARBON BLACK, TITANIUM DIOXIDE, or LEAD, which are known to the state of California to cause cancer, and LEAD which is known to cause birth defects or other reproductive harm. For more information go to www.P65Warnings.ca.gov.



Pneumatic: Push to Connect

Prestolok PLP
Push-to-Connect Fittings

Prestolok PLP Composite
Push-to-Connect Fittings

Prestolok PLM Metal
Push-to-Connect Fittings

Prestolok PLS
Stainless Steel
Push-to-Connect Fittings

Oscillating Elbows



For more product information visit:
www.parker.com/automation-fittings





Prestolok PLP Push-to-Connect Fittings

Prestolok PLP push-to-connect metal fittings with its wide variety configurations allows you to find the perfect product to meet your needs, optimizing the use of your equipment.

Product Features:

- Stainless steel grab ring
- Nickel-plated brass body
- Nitrile seal
- Polyacetal release button
- Corrosion resistance
- NPT threads

Markets:

- Industrial
- Automotive
- Climate Control
- Welding
- Packaging

Applications:

- Air
- Oil
- Inert Gases
- Vacuum

Specifications:

Pressure Range Up to 300 PSI (20.6 bar)
depending on tubing

Temperature Range 0° to +200° F (-17.7° to 93.3° C)

Note: Vacuum applications are dependent upon temperature and type of tubing used

Compatible Tubing:

- Polyethylene
- Polypropylene
- Plasticized Nylon
- Unplasticized Nylon
- Polyurethane 90 Durometer Shore A
- Polyurethane 94 Duromete Shore A

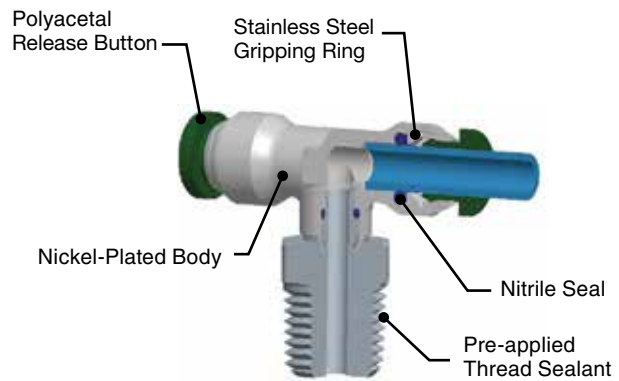













Assembly Instructions

1. Cut tubing squarely – maximum of 15° angle allowable.
2. Check that port or mating part is clean and free of debris.
3. Mark tubing to appropriate tube insertion length. (see Tube Insertion Chart on page N22)
4. Insert tubing until it bottoms
5. Pull on tubing to verify it is fully inserted
6. To disassemble, simply press release button, hold against body and pull tubing out of fitting.

WARNING These products can expose you to chemicals including LEAD which is known to the state of California to cause cancer and birth defects or other reproductive harm. For more information go to www.P65Warnings.ca.gov.



Tube to Male NPTF	68PLPR Male Connector Round Body  p. A7	W169PLP Male Elbow Swivel  p. A8	W169PLPNS Male Elbow  p. A8	W171PLP Male Run Tee Swivel  p. A8	W172PLP Male Branch Tee Swivel  p. A9	W68PLP Male Connector  p. A6
	Tube to Tube	164PLP Union Tee  p. A7	165PLP Union Elbow  p. A8	62PLP Union  p. A6	Tube to Female NPTF	66PLP Female Connector  p. A6
Bulkhead Unions		62PLPBH Bulkhead Union  p. A6	66PLPBH Female Bulkhead Union  p. A6	Tube to Straight Thread		Tube to Male BSPP
			PLPHBF4-B Male Connector  p. A7			

WARNING These products can expose you to chemicals including LEAD which is known to the state of California to cause cancer and birth defects or other reproductive harm. For more information go to www.P65Warnings.ca.gov.

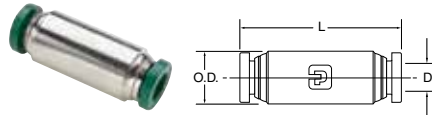

62PLP Union

PART NO.	TUBE SIZE IN	O.D.	L	FLOW DIA. D
62PLP-2	1/8	.375	1.40	.094
62PLP-3	3/16	.437	1.41	.156
62PLP-5/32	5/32	.375	1.41	.125
62PLP-4	1/4	.500	1.43	.188
62PLP-5	5/16	.562	1.65	.250
62PLP-6	3/8	.625	1.66	.312
62PLP-8	1/2	.750	1.82	.375

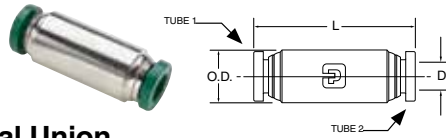

62PLP Unequal Union

PART NO.	TUBE 1 SIZE IN	TUBE 2 SIZE IN	O.D.	L	FLOW DIA. D
62PLP-5/32-2	5/32	1/8	.375	1.41	.094
62PLP-4-2	1/4	1/8	.500	1.43	.094
62PLP-4-5/32	1/4	5/32	.500	1.43	.125
62PLP-4-6	1/4	3/8	.625	1.66	.188
62PLP-6-8	3/8	1/2	.750	1.82	.312

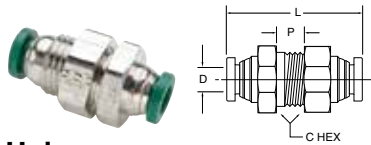

62PLPBH Bulkhead Union

PART NO.	TUBE SIZE IN	BULKHEAD HOLE DIA. B	C HEX	P MAX.	L	D
62PLPBH-2	1/8	7/16	9/16	.39	1.40	.094
62PLPBH-5/32	5/32	7/16	9/16	.39	1.41	.125
62PLPBH-4	1/4	9/16	11/16	.29	1.43	.188
62PLPBH-5	5/16	5/8	3/4	.60	1.65	.250
62PLPBH-6	3/8	3/4	7/8	.54	1.66	.312
62PLPBH-8	1/2	7/8	1	.66	2.04	.375

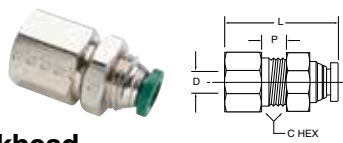

66PLPBH Female Bulkhead

PART NO.	TUBE SIZE IN	PIPE THD NPTF	C HEX	P MAX.	L	FLOW DIA. D	BKHD HOLE DIA.
66PLPBH-5/32-4	5/32	1/4	11/16	.19	1.39	.125	1/2
66PLPBH-4-4	1/4	1/4	11/16	.24	1.35	.188	9/16
66PLPBH-6-6	3/8	3/8	1	.22	1.47	.312	7/8
66PLPBH-8-6	1/2	3/8	1	.35	1.56	.344	7/8

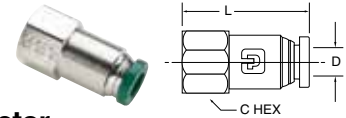

66PLP Female Connector

PART NO.	TUBE SIZE IN	PIPE THREAD NPTF	C HEX	L	FLOW DIA. D
66PLP-2-2	1/8	1/8	9/16	1.17	.094
66PLP-2-4	1/8	1/4	11/16	1.34	.094
66PLP-3-2	3/16	1/8	9/16	1.13	.156
66PLP-5/32-2	5/32	1/8	9/16	1.17	.125
66PLP-5/32-4	5/32	1/4	11/16	1.38	.125
66PLP-4-2	1/4	1/8	9/16	1.17	.188
66PLP-4-4	1/4	1/4	11/16	1.38	.188
66PLP-5-2	5/16	1/8	9/16	1.25	.250
66PLP-5-4	5/16	1/4	11/16	1.45	.250
66PLP-6-4	3/8	1/4	11/16	1.46	.312
66PLP-6-6	3/8	3/8	13/16	1.51	.312

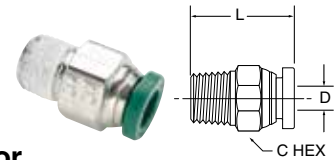

W68PLP Male Connector

PART NO.	TUBE SIZE IN	PIPE THD NPTF	C HEX	L	FLOW DIA. D
W68PLP-2-1	1/8	1/16	3/8	.79	.094
W68PLP-2-2	1/8	1/8	7/16	.79	.094
W68PLP-2-4	1/8	1/4	9/16	1.02	.094
W68PLP-3-2	3/16	1/8	7/16	.85	.156
W68PLP-3-4	3/16	1/4	9/16	1.01	.156
W68PLP-5/32-1	5/32	1/16		.88	.940
W68PLP-5/32-2	5/32	1/8	7/16	.80	.125
W68PLP-5/32-4	5/32	1/4	9/16	1.03	.125
W68PLP-4-1	1/4	1/16	1/2	1.07	.141
W68PLP-4-2	1/4	1/8	1/2	.89	.188
W68PLP-4-4	1/4	1/4	9/16	1.00	.188
W68PLP-4-6	1/4	3/8	3/4	1.04	.188
W68PLP-5-2	5/16	1/8	9/16	1.18	.250
W68PLP-5-4	5/16	1/4	9/16	1.04	.250
W68PLP-5-6	5/16	3/8	11/16	1.04	.250
W68PLP-6-2	3/8	1/8	5/8	1.21	.250
W68PLP-6-4	3/8	1/4	5/8	1.08	.312
W68PLP-6-6	3/8	3/8	11/16	1.02	.312
W68PLP-6-8	3/8	1/2	7/8	1.28	.312
W68PLP-8-4	1/2	1/4	13/16	1.44	.344
W68PLP-8-6	1/2	3/8	13/16	1.24	.344
W68PLP-8-8	1/2	1/2	7/8	1.35	.375
68PLP-5/32-4LT*	5/32	1/4-28	7/16	.88	.093

*SAE-LTThreads

WARNING These products can expose you to chemicals including LEAD which is known to the state of California to cause cancer and birth defects or other reproductive harm. For more information go to www.P65Warnings.ca.gov.

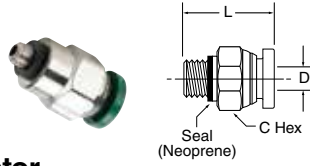

68PLP-X-0 Male Connector

PART NO.	TUBE SIZE IN	PIPE THREAD NPTF	C HEX	L	FLOW DIA. D
68PLP-2-0	1/8	10X32	3/8	.92	.094
68PLP-5/32-0	5/32	10X32	3/8	.90	.090
68PLP-4-0	1/4	10X32	1/2	.96	.094

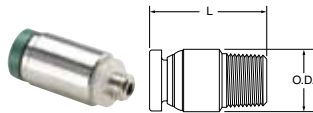

68PLPR Round Body Male Connector

PART NO.	TUBE SIZE IN	THREAD SIZE NPTF	INTERNAL HEX BROACH	BODY DIA. O.D.	L	FLOW DIA.
68PLPR-2-0*	1/8	10-32	3/32	3/8"	.89	.094
68PLPR-5/32-0*	5/32	10-32	3/32	3/8"	.91	.094
68PLPR-4-0*	1/4	10-32	3/32	1/2"	.95	.094
W68PLPR-5/32-1	5/32	1/16	1/8	7/16"	.87	.125
W68PLPR-5/32-2	5/32	1/8	1/8	7/16"	.79	.125
W68PLPR-4-1	1/4	1/16	5/32	1/2"	1.06	.156
W68PLPR-4-2	1/4	1/8	3/16	1/2"	.88	.188
W68PLPR-4-4	1/4	1/4	3/16	5/8"	.99	.188

*10-32 seal is neoprene

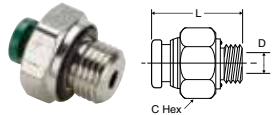

PLPHBF4-B Male Connector BSPP

PART NO.	TUBE SIZE IN	PIPE THD BSPP	C HEX	L	FLOW DIA. D
4-1/8PLPHBF4-B	1/4	1/8-28	11/16	1.13	.188
4-1/4PLPHBF4-B	1/4	1/4-19	3/4	1.13	.188
6-1/4PLPHBF4-B	3/8	1/4-19	3/4	1.26	.256

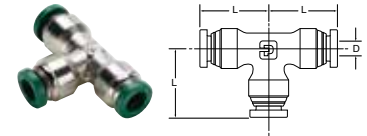

164PLP Union Tee

PART NO.	TUBE SIZE IN	L	FLOW DIA. D
164PLP-2	1/8	.74	.094
164PLP-3	3/16	.82	.156
164PLP-5/32	5/32	.77	.125
164PLP-4	1/4	.85	.188
164PLP-5	5/16	.97	.250
164PLP-6	3/8	1.01	.250
164PLP-8	1/2	1.15	.375

WARNING These products can expose you to chemicals including LEAD which is known to the state of California to cause cancer and birth defects or other reproductive harm. For more information go to www.P65Warnings.ca.gov.



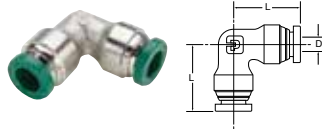

165PLP Union Elbow

PART NO.	TUBE SIZE IN	L	FLOW DIA. D
165PLP-2	1/8	.74	.094
165PLP-5/32	5/32	.77	.125
165PLP-4	1/4	.85	.188
165PLP-5	5/16	.97	.250
165PLP-6	3/8	1.01	.312
165PLP-8	1/2	1.15	.375

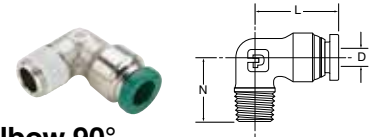

W169PLPNS Male Elbow 90°

PART NO.	TUBE IN	PIPE THD NPTF	L	N	FLOW DIA. D
W169PLPNS-2-2	1/8	1/8	.74	.67	.094
W169PLPNS5/32-2	5/32	1/8	.77	.67	.125
W169PLPNS5/32-4	5/32	1/4	.77	.87	.125
W169PLPNS-4-2	1/4	1/8	.85	.67	.188
W169PLPNS-4-4	1/4	1/4	.85	.87	.188
W169PLPNS-5-2	5/16	1/8	.97	.75	.234
W169PLPNS-5-4	5/16	1/4	.97	.94	.250
W169PLPNS-6-4	3/8	1/4	1.01	.94	.312
W169PLPNS-6-6	3/8	3/8	1.01	1.01	.312
W169PLPNS-6-8	3/8	1/2	1.01	1.27	.312
W169PLPNS-8-6	1/2	3/8	1.15	1.00	.375
W169PLPNS-8-8	1/2	1/2	1.15	1.27	.375
169PLPNS532-4LT*	5/32	1/4-28	.60	.48	.090

* SAE-LT Threads

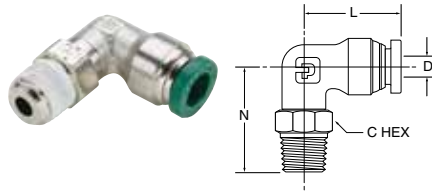

W169PLP Male Elbow Swivel 90°

PART NO.	TUBE SIZE IN	PIPE THREAD NPTF	C HEX	L	N	FLOW DIA. D
W169PLP-2-1	1/8	1/16	3/8	.74	.93	.160
W169PLP-2-2	1/8	1/8	7/16	.74	.92	.094
169PLP-2-0*	1/8	10-32	3/8	.74	.74	.080
W169PLP-2-4	1/8	1/4	9/16	.74	1.10	.094
W169PLP-3-2	3/16	1/8	7/16	.82	.92	.156
W169PLP-5/32-1	5/32	1/16	3/8	.84	.93	.160
W169PLP-5/32-2	5/32	1/8	7/16	.77	.92	.125
W169PLP-5/32-4	5/32	1/4	9/16	.77	1.10	.125
169PLP-5/32-0*	5/32	10-32	3/8	.85	.74	.080
W169PLP-4-1	1/4	1/16	3/8	.84	.93	.160
W169PLP-4-2	1/4	1/8	7/16	.85	.92	.156
W169PLP-4-4	1/4	1/4	9/16	.85	1.10	.156
W169PLP-4-6	1/4	3/8	11/16	.85	1.19	.156
169PLP-4-0*	1/4	10-32	3/8	.85	.74	.080
W169PLP-5-2	5/16	1/8	9/16	.97	1.02	.250
W169PLP-5-4	5/16	1/4	9/16	.97	1.24	.250
W169PLP-6-2	3/8	1/8	9/16	1.01	1.02	.250
W169PLP-6-4	3/8	1/4	9/16	1.01	1.24	.250
W169PLP-6-6	3/8	3/8	11/16	1.01	1.24	.250
W169PLP-6-8	3/8	1/2	7/8	1.01	1.48	.250
W169PLP-8-4	1/2	1/4	9/16	1.15	1.28	.312
W169PLP-8-6	1/2	3/8	11/16	1.15	1.31	.312
W169PLP-8-8	1/2	1/2	7/8	1.15	1.52	.312

*10-32 seal is neoprene

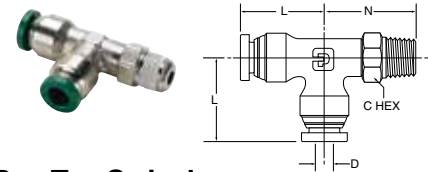

W171PLP Male Run Tee Swivel

PART NO.	TUBE SIZE IN	PIPE THREAD NPTF	C HEX	L	N	FLOW DIA. D
W171PLP-2-2	1/8	1/8	7/16	.74	.92	.094
W171PLP-5/32-2	5/32	1/8	7/16	.77	.92	.125
W171PLP-4-2	1/4	1/8	7/16	.85	.92	.156
W171PLP-4-4	1/4	1/4	9/16	.85	1.10	.156
W171PLP-4-6	1/4	3/8	11/16	.85	1.24	.156
W171PLP-5-2	5/16	1/8	9/16	.97	1.02	.250
W171PLP-5-4	5/16	1/4	9/16	.97	1.24	.250
W171PLP-6-4	3/8	1/4	9/16	1.01	1.24	.250
W171PLP-6-6	3/8	3/8	11/16	1.01	1.24	.250
W171PLP-8-6	1/2	3/8	11/16	1.15	1.31	.312
W171PLP-8-8	1/2	1/2	7/8	1.15	1.52	.312

WARNING These products can expose you to chemicals including LEAD which is known to the state of California to cause cancer and birth defects or other reproductive harm. For more information go to www.P65Warnings.ca.gov.

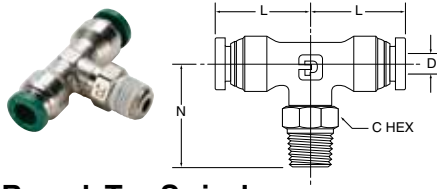

W172PLP Male Branch Tee Swivel

PART NO.	TUBE SIZE IN	PIPE THREAD NPTF	C HEX	L	N	FLOW DIA. D
W172PLP-2-2	1/8	1/8	7/16	.74	.92	.094
W172PLP-3-2	3/16	1/8	7/16	.82	.92	.156
W172PLP-5/32-2	5/32	1/8	7/16	.77	.92	.125
W172PLP-4-2	1/4	1/8	7/16	.85	.92	.156
W172PLP-4-4	1/4	1/4	9/16	.85	1.10	.156
W172PLP-4-6	1/4	3/8	11/16	.85	1.10	.156
W172PLP-5-2	5/16	1/8	9/16	.97	1.02	.250
W172PLP-5-4	5/16	1/4	9/16	.97	1.24	.250
W172PLP-6-4	3/8	1/4	9/16	1.01	1.24	.250
W172PLP-6-6	3/8	3/8	11/16	1.01	1.24	.250
W172PLP-6-8	3/8	1/2	7/8	1.00	1.48	.250
W172PLP-8-4	1/2	1/4	9/16	1.15	1.30	.312
W172PLP-8-6	1/2	3/8	11/16	1.15	1.31	.312
W172PLP-8-8	1/2	1/2	7/8	1.15	1.52	.312

WARNING These products can expose you to chemicals including LEAD which is known to the state of California to cause cancer and birth defects or other reproductive harm. For more information go to www.P65Warnings.ca.gov.





Prestolok PLP Composite Push-to-Connect Fittings

Prestolok push-to-connect composite fittings with its wide variety configurations allows you to find the perfect product to meet your needs, optimizing the use of your equipment.

Product Features:

- Stainless steel grab ring
- Glass-reinforced nylon 6.6 body
- Nitrile D-seal
- Nylon release button
- Corrosion and chemical resistance
- NPT, BSPT, BSPP, and metric threads
- Silicone Free

Compatible Tubing:

- Semi-rigid nylon
- Polyurethane 95 Durometer Shore A
- Nylon
- Fluoropolymer

Markets:

- Pneumatic
- Industrial
- Robotic
- Automation
- Printing
- Packaging
- Textile

Applications:

- Air
- Cutting Fluids
- Inert Gases
- Vacuum

Specifications:

Pressure Range	Up to 290 PSI (19.9 bar) depending on tubing
	Up to 260 PSI (17.9 bar) depending on tubing (3/16" size only)
Temperature Range	-4° to +175° F (-20° to +79.4° C)
	5° to +155° F (-15° to +68.3° C) (3/16" size only)
Vacuum Capability	28" Hg

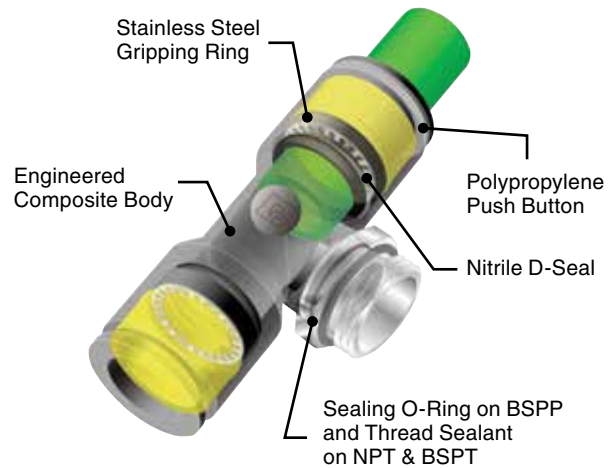

Assembly Instructions

1. Cut tubing squarely – maximum of 15° angle allowable.
2. Check that port or mating part is clean and free of debris.
3. Mark tubing to appropriate tube insertion length. (see Tube Insertion Chart on page N22)
4. Insert tubing until it bottoms
5. Pull on tubing to verify it is fully inserted
6. To disassemble, simply press release button, hold against body and pull tubing out of fitting.

WARNING These products can expose you to chemicals including NICKEL, which is known to the state of California to cause cancer. For more information go to www.P65Warnings.ca.gov.



Tube to Male NPTF	W369PLP Male Elbow  p. A16	W369PLPX Extended Male Elbow  p. A18	W379PLP 45° Male Elbow  p. A18	W372PLP Male Branch Tee  p. A19	W371PLP Male Run Tee  p. A21	W368PLP Male Y Connector  p. A23
	W369PLPBJ Single Banjo  p. A24	W369PLPTJ Twin Banjo  p. A26	W68LF Male Connector  p. A14	Tube to Male BSPT	W369PLP Male Elbow  p. A16	W372PLP Male Branch Tee  p. A20
W68LF Male Connector  p. A15	Tube to Female NPTF	66LF Female Connector  p. A14	377PLP Female Branch Tee  p. A21		370PLP Female Elbow  p. A24	Tube to Straight Thread
Tube to Tube		32PLP Union  p. A27	365PLP Union Elbow  p. A27	364PLP Union Tee  p. A28	362PLP Union Y  p. A28	
	24PLPD Double Multiple Tee  p. A30	347PLP Cross  p. A30	32PLPRC Connector for 2 Tubes  p. A34	Tube to Metric Tube	32PLP Converter Union  p. A27	
Bulkhead Unions	32PLPBH Bulkhead Union  p. A29	365PLPBH Bulkhead Elbow  p. A29	32PLPBHP Plug-in Bulkhead Union  p. A35			
	Standpipes	W68PLPSP Male Standpipe NPTF  p. A22	W68PLPSP Male Standpipe BSPT  p. A22	W68PLPSP Male Standpipe BSPP  p. A23	Plug-ins	369PLPSP Plug-In Elbow  p. A30
379PLPSP Plug-In 45° Elbow  p. A31		372PLPSP Plug-In Branch Tee  p. A31	371PLPSP Plug-In Run Tee  p. A31	362PLPSP Plug-In Y  p. A32		67PLP Tube Reducer  p. A33

WARNING These products can expose you to chemicals including NICKEL, which is known to the state of California to cause cancer. For more information go to www.P65Warnings.ca.gov.

Auxiliary Component	63PLP Double Male Union  p. A32	639PLP Plug  p. A33	Clip  p. A34	3151 End Cap  p. A34	3110-3330 End Cap  p. A35	
	W68LF Male Connector  p. A15	W369PLP Male Elbow  p. A17	W369PLPX Extended Male Elbow  p. A18	W379PLP 45° Male Elbow  p. A19	W372PLP Male Branch Tee  p. A20	W371PLP Male Run Tee  p. A22
W368PLP Male Y Connector  p. A23	W369PLPBJ Single Banjo  p. A24	Metric Tube to Male BSPP	68LF Male Connector  p. A16	369PLP Male Elbow  p. A17	369PLPX Extended Male Elbow  p. A18	379PLP 45° Male Elbow  p. A19
372PLP Male Branch Tee  p. A21	371PLP Male Run Tee  p. A22		368PLP Male Y Connector  p. A23	368PLPD Double Y Male Connector  p. A24		
Metric Tube to NPTF	W68LF Male Connector  p. A15	W369PLP Male Elbow  p. A17	W372PLP Male Branch Tee  p. A20	Metric Tube to Female BSPP	66LF Female Connector  p. A14	370PLP Female Elbow  p. A24
	68LFR Male Connector  p. A15	Metric Tube to Metric Straight Thread	32PLP Union  p. A27		365PLP Union Elbow  p. A27	364PLP Union Tee  p. A28
362PLPD Double Union Y  p. A29	24PLP Multiple Tee  p. A29		24PLPD Double Multiple Tee  p. A30	347PLP Cross  p. A30	32PLPRC Connector for 2 Tubes  p. A34	32PLPDRC Connector for 3 Tubes  p. A34
Metric Bulkhead Unions	32PLPBH Bulkhead Union  p. A29	365PLPBH Bulkhead Elbow  p. A29				

WARNING These products can expose you to chemicals including NICKEL, which is known to the state of California to cause cancer. For more information go to www.P65Warnings.ca.gov.

Metric Plug-ins	369PLPSP Plug-In Elbow  p. A30	369PLPSPX Extended Plug-In Elbow  p. A31	379PLPSP Plug-In 45° Male Elbow  p. A31	372PLPSP Plug-In Branch Tee  p. A31	371PLPSP Plug-In Run Tee  p. A32	362PLPSP Plug-In Y  p. A32
	362PLPSPD Double Plug-In Y  p. A32	67PLP Tube Reducer  p. A33	32PLPSP Tube Expander  p. A33	32PLPSP Tube Converter  p. A33	322PLPSP Barbed Connector  p. A33	Metric Banjo Fittings
369PLPBJB Single Banjo Body  p. A25	32PLPDJB Double Banjo Body  p. A25	369PLPTJB Twin Banjo Body  p. A25	68BJB Single Banjo Bolt  p. A25	68BJBD Double Banjo Bolt  p. A26	68JBTT Triple Banjo Bolt  p. A26	
376PLPBJ Banjo with Female Bolt  p. A26	369PLPTJ Twin Banjo  p. A26	32PLPDJ Double Banjo  p. A26	Auxiliary Component	63PLP Double Male Union  p. A32	639PLP Plug  p. A33	Clip  p. A34
3151 End Cap  p. A34	3110-3330 End Cap  p. A35					

WARNING These products can expose you to chemicals including NICKEL, which is known to the state of California to cause cancer. For more information go to www.P65Warnings.ca.gov.



66LF Female Connector BSPP

PART NO.	TUBE SIZE MM	THREAD BSPP	E MM	F MM	H MM
66LF-4M-M5	4	M5X0.8	6.5	8	19.5
66LF-4M-2G	4	1/8	9.5	13	22.5
66LF-4M-4G	4	1/4	13.5	16	26.5
66LF-6M-2G	6	1/8	9.5	13	24.5
66LF-6M-4G	6	1/4	13.5	16	28.5
66LF-8M-2G	8	1/8	9.5	13	29.0
66LF-8M-4G	8	1/4	13.5	16	33.0
66LF-8M-6G	8	3/8	14.0	19	34.0
66LF-10M-4G	10	1/4	13.5	16	36.0
66LF-10M-6G	10	3/8	14.0	19	36.0
66LF-10M-8G	10	1/2	19.5	24	41.5
66LF-12M-4G	12	1/4	14.0	19	39.5
66LF-12M-6G	12	3/8	14.0	19	40.0
66LF-12M-8G	12	1/2	19.5	24	45.5
66LF-14M-6G	14	3/8	14.0	22	42.5
66LF-16M-8G	16	1/2	15.0	27	49.0



66LF Female Connector NPT

PART NO.	TUBE SIZE IN	THREAD NPT	F MM	G IN	H IN	E IN
66LF-2-2	1/8	1/8	13	.43	.87	.37
66LF-2-4	1/8	1/4	16	.43	1.05	.55
66LF-4M-2	5/32 (4MM)	1/8	13	.33	.89	.37
66LF-4M-4	5/32 (4MM)	1/4	16	.33	1.06	.55
66LF-4-2	1/4	1/8	13	.42	.98	.37
66LF-4-4	1/4	1/4	16	.42	1.16	.55
66LF-8M-2	5/16 (8MM)	1/8	13	.53	1.14	.37
66LF-8M-4	5/16 (8MM)	1/4	16	.53	1.32	.55
66LF-6-2	3/8	1/8	16	.61	1.22	.37
66LF-6-4	3/8	1/4	16	.61	1.40	.55
66LF-6-6	3/8	3/8	22	.61	1.52	.65
66LF-8-4	1/2	1/4	20	.84	1.73	.47
66LF-8-6	1/2	3/8	22	.85	1.81	.65
66LF-8-8	1/2	1/2	24	.85	1.93	.77

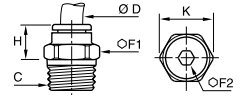

W68LF Male Connector NPT

PART NO.	TUBE SIZE IN	C NPT	F1 MM	F2 IN	H IN	K IN
W68LF-2-1	1/8	1/16	10	.07	.413	.433
W68LF-2-2	1/8	1/8	11	.07	.283	.472
W68LF-2-4	1/8	1/4	14	.07	.315	.591
W68LF-4M-2	5/32 (4MM)	1/8	11	.11	.334	.472
W68LF-4M-4	5/32 (4MM)	1/4	14	.11	.275	.590
W68LF-4-2	1/4	1/8	11	.16	.472	.472
W68LF-4-4	1/4	1/4	14	.16	.374	.590
W68LF-4-6	1/4	3/8	18	.19	.295	.767
W68LF-8M-2	5/16 (8MM)	1/8	13	.19	.787	.551
W68LF-8M-4	5/16 (8MM)	1/4	14	.25	.661	.590
W68LF-8M-6	5/16 (8MM)	3/8	18	.25	.464	.767
W68LF-6-2	3/8	1/8	16	.16	.894	.689
W68LF-6-4	3/8	1/4	16	.28	.807	.689
W68LF-6-6	3/8	3/8	18	.28	.689	.767
W68LF-6-8	3/8	1/2	22	.28	.610	.945
W68LF-8-4	1/2	1/4	22	.25	1.100	.945
W68LF-8-6	1/2	3/8	22	.28	1.100	.945
W68LF-8-8	1/2	1/2	22	.28	1.100	.945

WARNING These products can expose you to chemicals including NICKEL, which is known to the state of California to cause cancer. For more information go to www.P65Warnings.ca.gov.



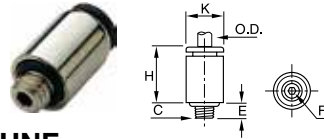

68LFR Male Connector UNF

PART NO.	TUBE SIZE IN	C UNF	E IN	F MM	H IN	K IN
68LFR-2-0	1/8	10-32	.13	2.0	.49	.32
68LFR-4M-0	5/32 (4MM)	10-32	.13	2.0	.54	.34
68LFR-4-1	1/4	1/16	-	3.0	.63	.42
68LFR-4-0	1/4	10-32	.13	2.0	.64	.46
68LFR-4-M5	1/4	M5	.14	2.5	.65	.41
68LFR-4-M7	1/4	M7	.18	4.0	.65	.41

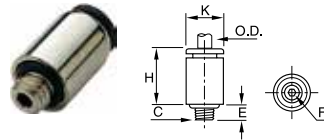

68LFR Male Connector Metric Straight Thread

PART NO.	TUBE SIZE MM	C UNF	E MM	F MM	H MM	K MM
68LFR-4M-M7	4	M7X1	4.6	3	14	9.95
68LFR-4M-M5	4	M5X0.8	3.5	2.5	14.5	8.50
68LFR-6M-M7	6	M7X1	4.6	3	16	9.90

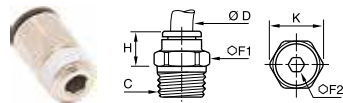

W68LF Male Connector BSPT

PART NO.	TUBE SIZE IN	C BSPT	F1 MM	F2 MM	H IN	K IN
W68LF-2-2R	1/8	1/8	10	2	.335	.433
W68LF-5/32-2R	5/32	1/8	10	3	.370	.430
W68LF-5/32-4R	5/32	1/4	14	3	.260	.590
W68LF-3-2R	3/16	1/8	11	3	.610	.510
W68LF-3-4R	3/16	1/4	14	3	.590	.650
W68LF-4-2R	1/4	1/8	11	4	.472	.472
W68LF-4-4R	1/4	1/4	14	4	.374	.591
W68LF-5-2R	5/16	1/8	13	5	.790	.550
W68LF-5-4R	5/16	1/4	14	6	.670	.590
W68LF-5-6R	5/16	3/8	17	6	.510	.730
W68LF-5-8R	5/16	1/2	21	6	.470	.910
W68LF-6-4R	3/8	1/4	16	7	.807	.689
W68LF-6-6R	3/8	3/8	17	7	.650	.728
W68LF-6-8R	3/8	1/2	21	7	.551	.906
W68LF-8-4R	1/2	1/4	22	6	1.060	.945
W68LF-8-6R	1/2	3/8	22	7	1.020	.945
W68LF-8-8R	1/2	1/2	24	7	.807	1.020

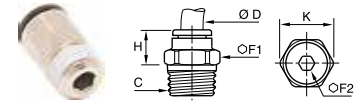

W68LF Male Connector Metric to NPT

PART NO.	TUBE SIZE MM	C NPT	F1 MM	F2 IN	H IN	K IN
W68LF-4M-2	4	1/8	11	3	.33	.47
W68LF-4M-4	4	1/4	14	3	.28	.59
W68LF-6M-2	6	1/8	11	4	.45	.47
W68LF-6M-4	6	1/4	14	4	.33	.59
W68LF-8M-2	8	1/8	13	5	.79	.55
W68LF-8M-4	8	1/4	14	6	.66	.59
W68LF-8M-6	8	3/8	18	6	.46	.77
W68LF-10M-4	10	1/4	16	7	.79	.69
W68LF-10M-6	10	3/8	18	8	.65	.77
W68LF-10M-8	10	1/2	22	8	.55	.95
W68LF-12M-6	12	3/8	19	9	.95	.83
W68LF-12M-8	12	1/2	22	10	.77	.95

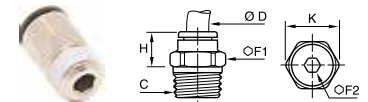

W68LF Male Connector Metric to BSPT

PART NO.	TUBE SIZE MM	C BSPT	F1 MM	F2 MM	H MM	K MM
W68LF-4M-2R	4	1/8	10	3	9.5	11.0
W68LF-4M-4R	4	1/4	14	3	6.5	15.0
W68LF-4M-6R	4	3/8	17	3	8.0	18.5
W68LF-6M-2R	6	1/8	11	4	11.5	11.0
W68LF-6M-4R	6	1/4	14	4	8.5	15.0
W68LF-6M-6R	6	3/8	17	4	8.5	18.5
W68LF-6M-8R	6	1/2	21	4	9.0	23.0
W68LF-8M-2R	8	1/8	13	5	20.0	14.0
W68LF-8M-4R	8	1/4	14	6	17.0	15.0
W68LF-8M-6R	8	3/8	17	6	13.0	18.5
W68LF-8M-8R	8	1/2	21	6	12.0	23.0
W68LF-10M-2R	10	1/8	16	5	22.5	17.5
W68LF-10M-4R	10	1/4	16	7	20.0	17.5
W68LF-10M-6R	10	3/8	17	8	16.5	18.5
W68LF-10M-8R	10	1/2	21	8	14.0	23.0
W68LF-12M-4R	12	1/4	19	7	26.5	21.0
W68LF-12M-6R	12	3/8	19	9	24.0	21.0
W68LF-12M-8R	12	1/2	21	9	19.5	23.0
W68LF-14M-6R	14	3/8	22	9	28.5	24.0
W68LF-14M-8R	14	1/2	24	10	23.5	26.0

WARNING These products can expose you to chemicals including NICKEL, which is known to the state of California to cause cancer. For more information go to www.P65Warnings.ca.gov.

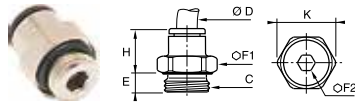

68LF Male Connector Metric to BSPP

PART NO.	TUBE SIZE MM	C BSPP	E MM	F1 MM	F2 MM	H MM	K MM
68LF-3M-M3	3	M3X0.5	2.50	8	-	12.5	8.5
68LF-3M-M5	3	M5X0.8	3.50	8	2.5	12.5	8.5
68LF-4M-M3	4	M3X0.5	2.50	8	-	14.5	8.5
68LF-4M-M5	4	M5X0.8	3.50	8	2.5	14.0	8.5
68LF-4M-M7	4	M7X1	5.00	10	2.5	14.0	11.0
68LF-4M-2G	4	1/8	4.50	13	3.0	11.5	14.0
68LF-4M-4G	4	1/4	5.50	16	3.0	10.5	17.5
68LF-6M-M5	6	M5X0.8	3.50	10	2.5	16.0	11.0
68LF-6M-M7	6	M7X1	5.00	10	3.0	16.0	11.0
68LF-6M-M10	6	M10X1	5.00	13	4.0	13.0	14.0
68LF-6M-M12	6	M12X1.5	5.50	15	4.0	13.0	16.0
68LF-6M-2G	6	1/8	4.50	13	4.0	13.0	14.0
68LF-6M-4G	6	1/4	5.50	16	4.0	12.5	17.5
68LF-6M-6G	6	3/8	5.50	20	4.0	13.0	22.0
68LF-6M-8G	6	1/2	7.50	24	4.0	20.0	26.0
68LF-8M-M10	8	M10X1	5.00	13	5.0	21.0	14.0
68LF-8M-M12	8	M12X1.5	5.50	15	5.0	21.0	16.0
68LF-8M-2G	8	1/8	4.50	13	5.0	20.5	14.0
68LF-8M-4G	8	1/4	5.50	16	6.0	19.5	17.5
68LF-8M-6G	8	3/8	5.50	20	6.0	18.0	22.0
68LF-8M-8G	8	1/2	7.50	24	6.0	16.5	26.0
68LF-10M-4G	10	1/4	5.50	16	7.0	23.0	17.5
68LF-10M-6G	10	3/8	5.50	20	8.0	19.5	22.0
68LF-10M-8G	10	1/2	7.50	24	8.0	18.5	26.0
68LF-12M-4G	12	1/4	5.50	19	7.0	27.5	21.0
68LF-12M-6G	12	3/8	5.50	20	9.0	27.0	22.0
68LF-12M-8G	12	1/2	7.00	24	10.0	22.5	26.0
68LF-14M-6G	14	3/8	5.50	22	9.0	29.5	24.0
68LF-14M-8G	14	1/2	7.00	24	11.0	28.0	26.0

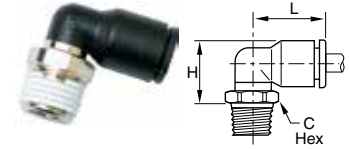

W369PLP Male Elbow - NPT

PART NO.	TUBE SIZE IN	THREAD NPT / UNF	C HEX MM	L	H
369PLP-2-0	1/8	10-32	8	.57	.52
W369PLP-2-1	1/8	1/16	10	.57	.53
W369PLP-2-2	1/8	1/8	11	.57	.53
W369PLP-2-4	1/8	1/4	14	.57	.55
369PLP-4M-0	5/32 (4MM)	10-32	8	.55	.53
W369PLP-4M-2	5/32 (4MM)	1/8	11	.55	.53
W369PLP-4M-4	5/32 (4MM)	1/4	14	.55	.55
W369PLP-3-2	3/16	1/8	11	.85	.67
369PLP-4-0	1/4	10-32	11	.71	.63
W369PLP-4-2	1/4	1/8	11	.71	.67
W369PLP-4-4	1/4	1/4	14	.71	.63
W369PLP-4-6	1/4	3/8	18	.71	.65
W369PLP-8M-2	5/16 (8MM)	1/8	11	.91	.75
W369PLP-8M-4	5/16 (8MM)	1/4	14	.91	.71
W369PLP-8M-6	5/16 (8MM)	3/8	18	.91	.73
W369PLP-6-2	3/8	1/8	15	1.08	.91
W369PLP-6-4	3/8	1/4	15	1.08	.91
W369PLP-6-6	3/8	3/8	18	1.08	.87
W369PLP-6-8	3/8	1/2	22	1.08	.91
W369PLP-8-4	1/2	1/4	20	1.38	1.22
W369PLP-8-6	1/2	3/8	20	1.38	1.22
W369PLP-8-8	1/2	1/2	24	1.38	1.12



W369PLP Male Elbow - BSPT

PART NO.	TUBE SIZE IN	THREAD BSPT	C HEX MM	L	H
W369PLP-2-2R	1/8	1/8	10	.57	.53
W369PLP-4M-2R	5/32 (4M)	1/8	10	.55	.53
W369PLP-4M-4R	5/32 (4M)	1/4	14	.55	.55
W369PLP-3-2R	3/16	1/8	11	.85	.67
W369PLP-4-2R	1/4	1/8	10	.71	.67
W369PLP-4-4R	1/4	1/4	14	.71	.63
W369PLP-8M-2R	5/16 (8M)	1/8	10	.91	.75
W369PLP-8M-4R	5/16 (8M)	1/4	14	.91	.71
W369PLP-8M-6R	5/16 (8M)	3/8	17	.91	.71
W369PLP-8M-8R	5/16 (8M)	1/2	21	.91	.77
W369PLP-6-4R	3/8	1/4	15	1.04	.87
W369PLP-6-6R	3/8	3/8	17	1.04	.87
W369PLP-8-4R	1/2	1/4	20	1.38	1.22
W369PLP-8-6R	1/2	3/8	20	1.38	1.22
W369PLP-8-8R	1/2	1/2	24	1.38	1.12

WARNING These products can expose you to chemicals including NICKEL, which is known to the state of California to cause cancer. For more information go to www.P65Warnings.ca.gov.



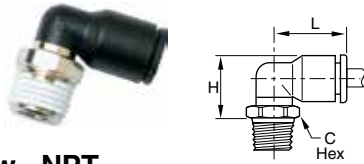

W369PLP Male Elbow - NPT

PART NO.	TUBE SIZE MM	THREAD NPT	C HEX MM	H	L
W369PLP-4M-2	4	1/8	11	.53	.55
W369PLP-4M-4	4	1/4	14	.55	.55
W369PLP-6M-2	6	1/8	11	.61	.63
W369PLP-6M-4	6	1/4	14	.63	.63
W369PLP-8M-2	8	1/8	11	.75	.91
W369PLP-8M-4	8	1/4	14	.71	.91
W369PLP-8M-6	8	3/8	18	.73	.91
W369PLP-10M-4	10	1/4	15	.91	1.04
W369PLP-10M-6	10	3/8	18	.87	1.04
W369PLP-10M-8	10	1/2	22	.91	1.04
W369PLP-12M-6	12	3/8	18	.98	1.22
W369PLP-12M-8	12	1/2	22	1.02	1.22

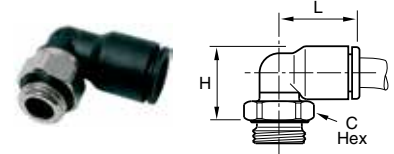

369PLP Male Elbow - BSPP

PART NO.	TUBE SIZE MM	BSPP / METRIC	C HEX MM	H	L
369PLP-3M-M3	3	M3X0.5	8	15.0	14.5
369PLP-3M-M5	3	M5X0.8	8	13.5	14.5
369PLP-4M-M3	4	M3X0.5	8	15.0	14.5
369PLP-4M-M5	4	M5X0.8	8	13.5	14.0
369PLP-4M-2G	4	1/8	13	13.0	14.0
369PLP-4M-4G	4	1/4	16	13.0	14.0
369PLP-6M-M5	6	M5X0.8	8	15.5	16.0
369PLP-6M-M7	6	M7X1	10	17.5	16.0
369PLP-6M-M10	6	M10X1	13	15.0	14.0
369PLP-6M-M12	6	M12X1.5	15	15.0	16.0
369PLP-6M-2G	6	1/8	13	15.0	16.0
369PLP-6M-4G	6	1/4	16	15.0	16.0
369PLP-6M-6G	6	3/8	20	15.5	16.0
369PLP-6M-8G	6	1/2	24	16.0	16.0
369PLP-8M-M10	8	M10X1	13	20.5	23.0
369PLP-8M-M12	8	M12X1.5	15	19.5	23.0
369PLP-8M-2G	8	1/8	13	20.5	23.0
369PLP-8M-4G	8	1/4	16	18.5	23.0
369PLP-8M-6G	8	3/8	20	18.5	23.0
369PLP-8M-8G	8	1/2	24	19.0	23.0
369PLP-10M-4G	10	1/4	16	23.5	26.5
369PLP-10M-6G	10	3/8	20	22.0	26.5
369PLP-10M-8G	10	1/2	24	22.0	26.5
369PLP-12M-4G	12	1/4	16	26.5	31.0
369PLP-12M-6G	12	3/8	20	25.0	31.0
369PLP-12M-8G	12	1/2	24	25.0	31.0
369PLP-14M-6G	14	3/8	20	32.5	35.5
369PLP-14M-8G	14	1/2	24	27.0	35.5
369PLP-16M-6G	16	3/8	27	54.5	39
369PLP-16M-8G	16	1/2	27	54.5	39

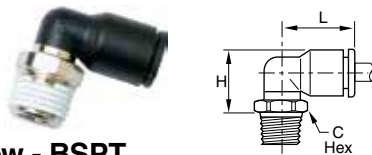

W369PLP Male Elbow - BSPT

PART NO.	TUBE SIZE MM	THREAD BSPT	C HEX MM	H	L
W369PLP-4M-2R	4	1/8	10	13.5	14.0
W369PLP-4M-4R	4	1/4	14	14.0	14.0
W369PLP-4M-6R	4	3/8	17	13.5	14.0
W369PLP-6M-2R	6	1/8	10	15.5	16.0
W369PLP-6M-4R	6	1/4	14	16.0	16.0
W369PLP-6M-6R	6	3/8	17	16.0	16.0
W369PLP-6M-8R	6	1/2	21	16.5	16.0
W369PLP-8M-2R	8	1/8	10	19.0	23.0
W369PLP-8M-4R	8	1/4	14	18.0	23.0
W369PLP-8M-6R	8	3/8	17	18.0	23.0
W369PLP-8M-8R	8	1/2	21	19.5	23.0
W369PLP-10M-2R	10	1/8	15	23.0	26.5
W369PLP-10M-4R	10	1/4	15	22.0	26.5
W369PLP-10M-6R	10	3/8	17	22.0	26.5
W369PLP-10M-8R	10	1/2	21	22.0	26.5
W369PLP-12M-4R	12	1/4	15	25.0	31.0
W369PLP-12M-6R	12	3/8	17	25.0	31.0
W369PLP-12M-8R	12	1/2	21	25.0	31.0
W369PLP-14M-6R	14	3/8	20	30.5	35.5
W369PLP-14M-8R	14	1/2	24	28.5	35.5
W369PLP-16M-6R	16	3/8	27	53	39.0
W369PLP-16M-8R	16	1/2	27	53	39.0

WARNING These products can expose you to chemicals including NICKEL, which is known to the state of California to cause cancer. For more information go to www.P65Warnings.ca.gov.

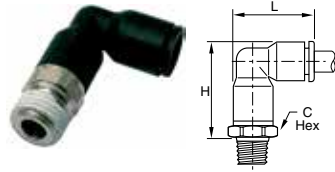

W369PLPX Extended Male Elbow - NPT

PART NO.	TUBE SIZE IN	THREAD NPT / UNF	C HEX MM	H	L
369PLPX-2-0	1/8	10-32	8	.91	.75
W369PLPX-2-2	1/8	1/8	11	.91	.75
W369PLPX-2-4	1/8	1/4	14	.93	.75
369PLPX-4M-0	5/32 (4MM)	10-32	8	.91	.75
W369PLPX-4M-2	5/32 (4MM)	1/8	11	.91	.75
W369PLPX-4M-4	5/32 (4MM)	1/4	14	.93	.75
369PLPX-4-0	1/4	10-32	11	1.10	.93
369PLPX-4-M7	1/4	M7	9	1.17	.93
W369PLPX-4-2	1/4	1/8	11	1.12	.93
W369PLPX-4-4	1/4	1/4	14	1.08	.93
W369PLPX-4-6	1/4	3/8	17	1.12	.93
W369PLPX-8M-2	5/16 (8MM)	1/8	13	1.32	1.16
W369PLPX-8M-4	5/16 (8MM)	1/4	14	1.28	1.16
W369PLPX-6-2	3/8	1/8	17	1.40	1.34
W369PLPX-6-4	3/8	1/4	17	1.41	1.33
W369PLPX-6-6	3/8	3/8	18	1.45	1.33

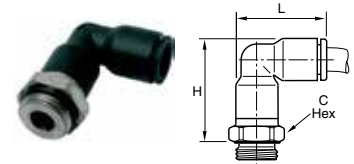

369PLPX Extended Male Elbow - BSPP

PART NO.	TUBE SIZE MM	BSPP / METRIC	C HEX MM	H
369PLPX-4M-M5	4	M5X0.8	8	23.0
369PLPX-4M-M7	4	M7X1	10	22.5
369PLPX-4M-2G	4	1/8	13	22.5
369PLPX-4M-4G	4	1/4	16	22.5
369PLPX-6M-M5	6	M5X0.8	10	27.5
369PLPX-6M-M7	6	M7X1	10	26.0
369PLPX-6M-2G	6	1/8	13	27.0
369PLPX-6M-4G	6	1/4	16	27.0
369PLPX-8M-2G	8	1/8	13	36.0
369PLPX-8M-4G	8	1/4	16	33.0
369PLPX-8M-6G	8	3/8	20	33.0
369PLPX-10M-4G	10	1/4	16	40.5
369PLPX-10M-6G	10	3/8	20	40.5
369PLPX-10M-8G	10	1/2	24	40.5
369PLPX-12M-4G	12	1/4	19	44.5
369PLPX-12M-6G	12	3/8	20	42.0
369PLPX-12M-8G	12	1/2	24	42.0
369PLPX-14M-6G	14	3/8	22	51.0
369PLPX-14M-8G	14	1/2	24	48.5

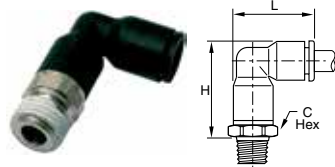

W369PLPX Extended Male Elbow - BSPT

PART NO.	TUBE SIZE MM	THREAD BSPT	C HEX MM	H	L
W369PLPX-4M-2R	4	1/8	10	23.0	19.0
W369PLPX-4M-4R	4	1/4	14	23.5	19.0
W369PLPX-6M-2R	6	1/8	10	27.0	22.5
W369PLPX-6M-4R	6	1/4	14	27.5	22.5
W369PLPX-8M-2R	8	1/8	13	34.5	29.5
W369PLPX-8M-4R	8	1/4	14	32.5	29.5
W369PLPX-8M-6R	8	3/8	17	33.0	29.5
W369PLPX-10M-4R	10	1/4	15	39.5	34.5
W369PLPX-10M-6R	10	3/8	17	39.5	34.5
W369PLPX-10M-8R	10	1/2	21	39.5	34.5
W369PLPX-12M-4R	12	1/4	19	45.5	40.5
W369PLPX-12M-6R	12	3/8	19	45.5	40.5
W369PLPX-12M-8R	12	1/2	21	45.5	40.5
W369PLPX-14M-6R	14	3/8	21	51.5	46.5
W369PLPX-14M-8R	14	1/2	21	51.5	46.5



W379PLP Male Elbow 45° - NPT

PART NO.	TUBE SIZE IN	THREAD NPT / UNF	C HEX MM	H	L
379PLP-2-0	1/8	10-32	8	.91	.49
W379PLP-2-2	1/8	1/8	11	.81	.49
W379PLP-4-2	1/4	1/8	11	.98	.57
W379PLP-4-4	1/4	1/4	14	.98	.57
W379PLP-4-M7	1/4	M7	9	1.14	.57
W379PLP-6-4	3/8	1/4	17	1.36	.91
W379PLP-6-6	3/8	3/8	18	1.36	.91

WARNING These products can expose you to chemicals including NICKEL, which is known to the state of California to cause cancer. For more information go to www.P65Warnings.ca.gov.

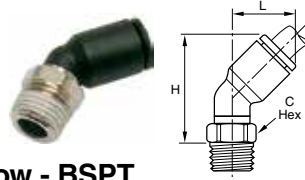

W379PLP 45° Male Elbow - BSPT

PART NO.	TUBE SIZE MM	BSPT	C HEX MM	H	L
W379PLP-4M-2R	4	1/8	10	24.5	13.0
W379PLP-6M-2R	6	1/8	10	28.0	14.5
W379PLP-6M-4R	6	1/4	14	30.0	14.5
W379PLP-8M-2R	8	1/8	10	33.5	19.5
W379PLP-8M-4R	8	1/4	14	33.5	19.5
W379PLP-8M-6R	8	3/8	17	33.5	19.5
W379PLP-10M-4R	10	1/4	15	38.5	23.0
W379PLP-10M-6R	10	3/8	17	39.0	23.0
W379PLP-10M-8R	10	1/2	21	40.5	23.0
W379PLP-12M-4R	12	1/4	15	44.0	26.0
W379PLP-12M-6R	12	3/8	17	44.0	26.0
W379PLP-12M-8R	12	1/2	21	46.0	26.0

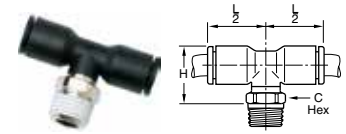

W372PLP Male Branch Tee - NPT

PART NO.	TUBE SIZE IN	THREAD NPT / UNF	C HEX MM	L/2	H
372PLP-2-0	1/8	10-32	8	.57	.61
W372PLP-2-1	1/8	1/16	10	.57	.61
W372PLP-2-2	1/8	1/8	11	.57	.61
W372PLP-2-4	1/8	1/4	14	.57	.63
372PLP-4M-0	5/32 (4MM)	10-32	8	.55	.71
W372PLP-4M-4	5/32 (4MM)	1/4	14	.55	.63
W372PLP-3-2	3/16	1/8	11	.85	.67
W372PLP-4-2	1/4	1/8	11	.71	.67
W372PLP-4-4	1/4	1/4	14	.71	.63
W372PLP-4-6	1/4	3/8	18	.71	.65
W372PLP-5-2	5/16	1/8	11	.91	.87
W372PLP-5-4	5/16	1/4	14	.91	.83
W372PLP-5-6	5/16	3/8	18	.91	.85
W372PLP-6-2	3/8	1/8	15	1.04	.99
W372PLP-6-4	3/8	1/4	15	1.04	.99
W372PLP-6-6	3/8	3/8	18	1.04	.95
W372PLP-6-8	3/8	1/2	22	1.04	.98
W372PLP-8-4	1/2	1/4	20	1.38	1.22
W372PLP-8-6	1/2	3/8	20	1.38	1.22
W372PLP-8-8	1/2	1/2	24	1.38	1.21

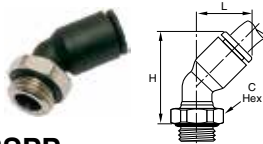

379PLP 45° Male Elbow - BSPP

PART NO.	TUBE SIZE MM	BSPP / M5	C HEX MM	H	L
379PLP-4M-M5	4	M5X0.8	8	23.0	13.0
379PLP-4M-2G	4	1/8	13	25.0	13.0
379PLP-6M-M5	6	M5X0.8	8	30.0	14.5
379PLP-6M-2G	6	1/8	13	28.5	14.5
379PLP-6M-4G	6	1/4	16	29.5	14.5
379PLP-8M-2G	8	1/8	13	36.0	19.5
379PLP-8M-4G	8	1/4	16	34.5	19.5
379PLP-8M-6G	8	3/8	20	34.5	19.5
379PLP-10M-4G	10	1/4	16	40.5	23.0
379PLP-10M-6G	10	3/8	20	39.0	23.0
379PLP-10M-8G	10	1/2	24	41.0	23.0
379PLP-12M-4G	12	1/4	16	46.0	26.0
379PLP-12M-6G	12	3/8	20	44.5	26.0
379PLP-12M-8G	12	1/2	24	46.0	26.0

WARNING These products can expose you to chemicals including NICKEL, which is known to the state of California to cause cancer. For more information go to www.P65Warnings.ca.gov.

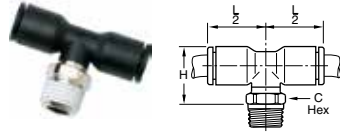

W372PLP Male Branch Tee - BSPT

PART NO.	TUBE SIZE IN	THREAD BSPT	C HEX MM	L/2	H
W372PLP-2-2R	1/8	1/8	10	.55	.61
W372PLP-4M-2R	5/32 (4MM)	1/8	10	.55	.61
W372PLP-4M-4R	5/32 (4MM)	1/4	14	.55	.63
W372PLP-3-2R	3/16	1/8	11	.85	.67
W372PLP-3-4R	3/16	1/4	14	.85	.67
W372PLP-4-2R	1/4	1/8	10	.71	.67
W372PLP-4-4R	1/4	1/4	14	.71	.63
W372PLP-8M-2R	5/16 (8MM)	1/8	10	.91	.87
W372PLP-8M-4R	5/16 (8MM)	1/4	14	.91	.83
W372PLP-8M-6R	5/16 (8MM)	3/8	17	.91	.83
W372PLP-6-4R	3/8	1/4	15	1.04	.95
W372PLP-6-6R	3/8	3/8	17	1.04	.95
W372PLP-8-4R	1/2	1/4	20	1.38	1.24
W372PLP-8-6R	1/2	3/8	20	1.38	1.22

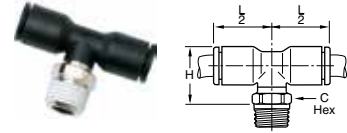

W372PLP Male Branch Tee - BSPT

PART NO.	TUBE SIZE MM	BSPT	C HEX MM	H	L/2
W372PLP-4M-2R	4	1/8	10	15.5	14.0
W372PLP-4M-4R	4	1/4	14	16.0	14.0
W372PLP-6M-2R	6	1/8	10	17.5	16.0
W372PLP-6M-4R	6	1/4	14	18.0	16.0
W372PLP-8M-2R	8	1/8	10	22.0	23.0
W372PLP-8M-4R	8	1/4	14	21.0	23.0
W372PLP-8M-6R	8	3/8	17	21.0	23.0
W372PLP-10M-4R	10	1/4	15	24.0	26.5
W372PLP-10M-6R	10	3/8	17	24.0	26.5
W372PLP-10M-8R	10	1/2	21	24.0	26.5
W372PLP-12M-4R	12	1/4	15	27.0	31.0
W372PLP-12M-6R	12	3/8	17	27.0	31.0
W372PLP-12M-8R	12	1/2	21	27.0	31.0
W372PLP-14M-6R	14	3/8	20	30.5	35.5
W372PLP-14M-8R	14	1/2	24	28.5	35.5
W372PLP-16M-6R	16	3/8	27	53.0	38.5
W372PLP-16M-8R	16	1/2	27	53.0	38.5

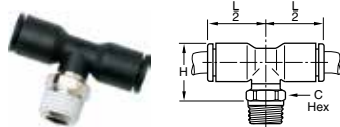

W372PLP Male Branch Tee - NPT

PART NO.	TUBE SIZE MM	NPT	C HEX MM	H	L/2
W372PLP-4M-2	4	1/8	11	.61	.55
W372PLP-4M-4	4	1/4	14	.63	.55
W372PLP-6M-2	6	1/8	11	.69	.63
W372PLP-6M-4	6	1/4	14	.71	.63
W372PLP-8M-2	8	1/8	11	.87	.91
W372PLP-8M-4	8	1/4	14	.83	.91
W372PLP-8M-6	8	3/8	18	.85	.91
W372PLP-10M-4	10	1/4	15	.98	1.04
W372PLP-10M-6	10	3/8	18	.95	1.04
W372PLP-10M-8	10	1/2	22	.98	1.04
W372PLP-12M-6	12	3/8	18	1.06	1.22
W372PLP-12M-8	12	1/2	22	.98	1.22

WARNING These products can expose you to chemicals including NICKEL, which is known to the state of California to cause cancer. For more information go to www.P65Warnings.ca.gov.

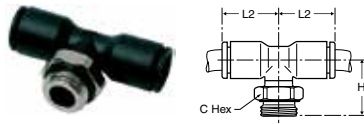

372PLP Male Branch Tee - BSPP

PART NO.	TUBE SIZE MM	BSPP / M5	C HEX MM	H	L/2
372PLP-4M-M5	4	M5X0.8	8	17.5	14.0
372PLP-4M-2G	4	1/8	13	15.0	14.0
372PLP-4M-4G	4	1/4	16	15.0	14.0
372PLP-6M-M5	6	M5X0.8	8	19.5	16.0
372PLP-6M-2G	6	1/8	13	17.0	16.0
372PLP-6M-4G	6	1/4	16	17.0	16.0
372PLP-8M-2G	8	1/8	13	23.5	23.0
372PLP-8M-4G	8	1/4	16	21.5	23.0
372PLP-8M-6G	8	3/8	20	21.5	23.0
372PLP-10M-4G	10	1/4	16	26.0	26.5
372PLP-10M-6G	10	3/8	20	24.0	26.5
372PLP-10M-8G	10	1/2	24	24.0	26.5
372PLP-12M-4G	12	1/4	16	29.0	31.0
372PLP-12M-6G	12	3/8	20	27.0	31.0
372PLP-12M-8G	12	1/2	24	27.0	31.0
372PLP-14M-6G	14	3/8	20	32.5	35.5
372PLP-14M-8G	14	1/2	24	27.0	35.5
372PLP-16M-6G	16	3/8	27	54.5	38.5
372PLP-16M-8G	16	1/2	27	54.5	38.5

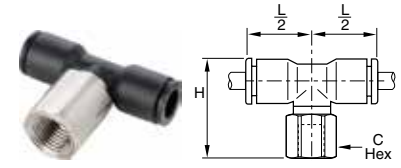

377PLP Female Branch Tee - NPT

PART NO.	TUBE SIZE IN	THREAD NPT / UNF	C HEX MM	L/2	H
377PLP-2-2	1/8	1/8	13	.57	.99
377PLP-4M-2	5/32 (4MM)	1/8	13	.55	.91
377PLP-4M-4	5/32 (4MM)	1/4	16	.55	1.08
377PLP-4-2	1/4	1/8	13	.71	1.02
377PLP-4-4	1/4	1/4	16	.71	1.18
377PLP-8M-2	5/16 (8MM)	1/8	13	.91	1.24
377PLP-8M-4	5/16 (8MM)	1/4	16	.91	1.40
377PLP-6-4	3/8	1/4	16	1.04	1.60
377PLP-8-6	1/2	3/8	22	1.38	1.88

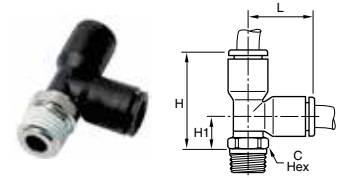

W371PLP Male Run Tee - NPT

PART NO.	TUBE SIZE IN	THREAD NPT / UNF	C HEX MM	L	H	H1
371PLP-2-0	1/8	10-32	8	.57	.92	.35
W371PLP-2-1	1/8	1/16	10	.57	.93	.35
W371PLP-2-2	1/8	1/8	11	.57	.93	.35
371PLP-4M-0	5/32 (4MM)	10-32	8	.57	1.02	.45
W371PLP-4M-2	5/32 (4MM)	1/8	11	.57	.93	.53
W371PLP-4M-4	5/32 (4MM)	1/4	14	.57	.94	.37
W371PLP-3-2	3/16	1/8	11	.85	1.31	.45
W371PLP-4-2	1/4	1/8	11	.69	1.16	.45
W371PLP-4-4	1/4	1/4	14	.69	1.12	.41
W371PLP-4-6	1/4	3/8	18	.69	1.14	.43
W371PLP-8M-2	5/16 (8MM)	1/8	11	.91	1.38	.49
W371PLP-8M-4	5/16 (8MM)	1/4	14	.91	1.34	.45
W371PLP-8M-6	5/16 (8MM)	3/8	18	.91	1.36	.47
W371PLP-6-2	3/8	1/8	15	1.04	1.63	.60
W371PLP-6-4	3/8	1/4	15	1.04	1.63	.60
W371PLP-6-6	3/8	3/8	18	1.04	1.60	.55
W371PLP-6-8	3/8	1/2	22	1.04	1.63	.59
W371PLP-8-4	1/2	1/4	20	1.38	2.17	.79
W371PLP-8-6	1/2	3/8	20	1.38	2.17	.79
W371PLP-8-8	1/2	1/2	24	1.38	2.07	.79

WARNING These products can expose you to chemicals including NICKEL, which is known to the state of California to cause cancer. For more information go to www.P65Warnings.ca.gov.

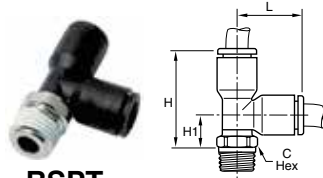

W371PLP Male Run Tee - BSPT

PART NO.	TUBE SIZE MM	THREAD BSPT	C HEX MM	H	H1	L
W371PLP-4M-2R	4	1/8	10	23.5	9.0	14.5
W371PLP-4M-4R	4	1/4	14	24.0	9.5	14.5
W371PLP-6M-2R	6	1/8	10	27.5	10.0	17.5
W371PLP-6M-4R	6	1/4	14	28.0	10.5	17.5
W371PLP-8M-2R	8	1/8	10	35.0	12.0	23.0
W371PLP-8M-4R	8	1/4	14	34.0	11.0	23.0
W371PLP-8M-6R	8	3/8	17	34.0	11.0	23.0
W371PLP-10M-4R	10	1/4	15	40.5	14.0	26.5
W371PLP-10M-6R	10	3/8	17	40.5	14.0	26.5
W371PLP-10M-8R	10	1/2	21	40.5	14.0	26.5
W371PLP-12M-4R	12	1/4	15	46.5	15.5	31.0
W371PLP-12M-6R	12	3/8	17	46.5	15.5	31.0
W371PLP-12M-8R	12	1/2	21	46.5	15.5	31.0
W371PLP-14M-8R	14	1/2	24	52.5	17.5	35.5
W371PLP-16M-6R	16	3/8	27	38.5	78	39.5
W371PLP-16M-8R	16	1/2	27	38.5	78	39.5

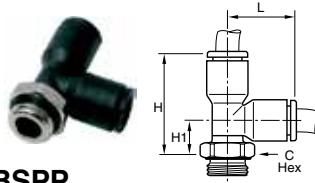

371PLP Male Run Tee - BSPP

PART NO.	TUBE SIZE MM	BSPP / M5	C HEX MM	H	H1	L
371PLP-4M-M5	4	M5X0.8	8	26.0	11.5	14.5
371PLP-4M-2G	4	1/8	13	23.0	8.5	14.5
371PLP-4M-4G	4	1/4	16	23.0	8.5	14.5
371PLP-6M-M5	6	M5X0.8	8	29.5	12.5	17.5
371PLP-6M-2G	6	1/8	13	27.0	10.0	17.5
371PLP-6M-4G	6	1/4	16	27.0	10.0	17.5
371PLP-8M-2G	8	1/8	13	36.5	14.0	23.0
371PLP-8M-4G	8	1/4	16	34.5	12.0	23.0
371PLP-8M-6G	8	3/8	20	34.5	12.0	23.0
371PLP-10M-4G	10	1/4	16	42.0	15.5	26.5
371PLP-10M-6G	10	3/8	20	40.5	14.0	26.5
371PLP-10M-8G	10	1/2	24	40.5	14.0	26.5
371PLP-12M-4G	12	1/4	16	48.0	17.0	31.0
371PLP-12M-6G	12	3/8	20	46.5	15.5	31.0
371PLP-12M-8G	12	1/2	24	46.5	15.5	31.0
371PLP-14M-6G	14	3/8	20	56.5	21.5	35.5
371PLP-14M-8G	14	1/2	24	51.0	16.0	35.5
371PLP-16M-6G	16	3/8	27	38.5	79.5	41
371PLP-16M-8G	16	1/2	27	38.5	79.5	41

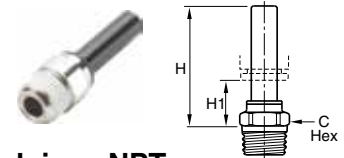

W68PLPSP Male Standpipe - NPT

PART NO.	TUBE SIZE IN	THREAD NPT / UNF	C HEX MM	H	H1
68PLPSP-4M-0	5/32 (4MM)	10-32	8	1.24	
W68PLPSP-4M-2	5/32 (4MM)	1/8	11	1.02	.57
W68PLPSP-4M-4	5/32 (4MM)	1/4	14	1.04	.59
W68PLPSP-4-2	1/4	1/8	11	1.18	.61
W68PLPSP-4-4	1/4	1/4	14	1.12	.57
W68PLPSP-8M-2	5/16 (8MM)	1/8	11	1.16	.43
W68PLPSP-8M-4	5/16 (8MM)	1/4	14	1.12	.39
W68PLPSP-6-2	3/8	1/8	15	1.75	.65
W68PLPSP-6-4	3/8	1/4	15	1.42	.67
W68PLPSP-6-6	3/8	3/8	17	1.42	.61
W68PLPSP-8-6	1/2	3/8	17	1.44	.37
W68PLPSP-8-8	1/2	1/2	21	1.46	.39

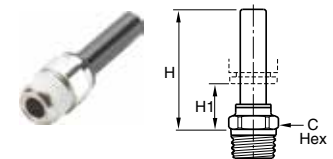

W68PLPSP Male Standpipe - BSPT

PART NO.	TUBE SIZE MM	BSPT	C HEX MM	H	H1
W68PLPSP-4M-2R	4	1/8	10	26.0	14.0
W68PLPSP-4M-4R	4	1/4	14	26.5	14.5
W68PLPSP-6M-2R	6	1/8	10	28.0	14.0
W68PLPSP-6M-4R	6	1/4	14	28.5	14.5
W68PLPSP-8M-2R	8	1/8	10	29.5	11.0
W68PLPSP-8M-4R	8	1/4	14	28.5	10.0
W68PLPSP-10M-4R	10	1/4	15	36.0	15.5
W68PLPSP-10M-6R	10	3/8	17	36.0	15.5
W68PLPSP-10M-8R	10	1/2	21	36.0	15.5
W68PLPSP-12M-6R	12	3/8	17	36.5	12.0
W68PLPSP-12M-8R	12	1/2	21	36.5	12.0

WARNING These products can expose you to chemicals including NICKEL, which is known to the state of California to cause cancer. For more information go to www.P65Warnings.ca.gov.

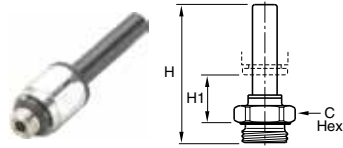

68PLPSP Male Standpipe - BSPP

PART NO.	TUBE SIZE MM	BSPP	C HEX MM	H	H1
68PLPSP-4M-M5	4	M5X0.8	8	31.0	16.0
68PLPSP-4M-2G	4	1/8	13	30.0	13.5
68PLPSP-4M-4G	4	1/4	16	31.0	13.5
68PLPSP-6M-2G	6	1/8	13	32.0	13.5
68PLPSP-6M-4G	6	1/4	16	33.0	13.5
68PLPSP-8M-2G	8	1/8	13	35.5	12.5
68PLPSP-8M-4G	8	1/4	16	34.5	10.5
68PLPSP-8M-6G	8	3/8	20	34.5	10.5
68PLPSP-10M-4G	10	1/4	16	43.5	17.5
68PLPSP-10M-6G	10	3/8	20	41.5	15.5
68PLPSP-10M-8G	10	1/2	24	41.5	15.5
68PLPSP-12M-6G	12	3/8	20	42.0	12.0
68PLPSP-12M-8G	12	1/2	24	43.5	12.0
68PLPSP-14M-6G	14	3/8	20	46.5	14.0
68PLPSP-14M-8G	14	1/2	24	48.0	13.5

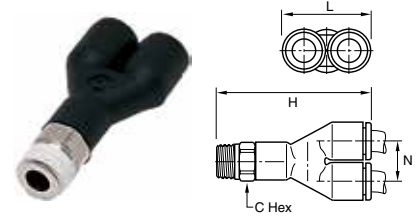

W368PLP Male Y Connector - BSPT

PART NO.	TUBE SIZE MM	BSPT	C HEX MM	H	L	N
W368PLP-4M-2R	4	1/8	10	32.5	17.5	9.0
W368PLP-4M-4R	4	1/4	14	33.0	17.5	9.0
W368PLP-6M-2R	6	1/8	10	39.5	21.5	1.0
W368PLP-6M-4R	6	1/4	14	40.0	21.5	1.0
W368PLP-8M-2R	8	1/8	13	56.5	28.0	14.5
W368PLP-8M-4R	8	1/4	14	55.5	28.0	14.5
W368PLP-8M-6R	8	3/8	16	48.5	28.0	14.5
W368PLP-10M-4R	10	1/4	14	60.0	39.0	20.0
W368PLP-10M-6R	10	3/8	16	60.5	39.0	20.0
W368PLP-10M-8R	10	1/2	24	61.0	39.0	20.0
W368PLP-12M-6R	12	3/8	19	66.0	39.0	20.0
W368PLP-12M-8R	12	1/2	21	66.0	39.0	20.0



W368PLP Male Y Connector - NPT

PART NO.	TUBE SIZE IN	THREAD NPT	C HEX MM	H	L	N
W368PLP-4M-2	5/32 (4MM)	1/8	11	1.28	.69	.35
W368PLP-4M-4	5/32 (4MM)	1/4	14	1.30	.69	.35
W368PLP-4-2	1/4	1/8	11	1.61	.87	.45
W368PLP-4-4	1/4	1/4	14	1.56	.87	.45
W368PLP-6-4	3/8	1/4	17	2.24	1.30	.67
W368PLP-6-6	3/8	3/8	18	2.28	1.30	.67



368PLP Male Y Connector - BSPP

PART NO.	TUBE SIZE MM	BSPP / M5	C HEX MM	H	L	N
368PLP-4M-M5	4	M5X0.8	8	32.5	17.5	9.0
368PLP-4M-2G	4	1/8	13	32.0	17.5	9.0
368PLP-4M-4G	4	1/4	16	32.0	17.5	9.0
368PLP-6M-M5	6	M5X0.8	10	39.5	21.5	11.0
368PLP-6M-2G	6	1/8	13	39.0	21.5	11.0
368PLP-6M-4G	6	1/4	16	39.0	21.5	11.0
368PLP-8M-2G	8	1/8	13	56.0	28.0	14.5
368PLP-8M-4G	8	1/4	16	55.0	28.0	14.5
368PLP-8M-6G	8	3/8	19	54.0	28.0	14.5
368PLP-10M-4G	10	1/4	16	63.5	33.0	17.0
368PLP-10M-6G	10	3/8	20	63.5	33.0	17.0
368PLP-10M-8G	10	1/2	20	65.0	33.0	17.0
368PLP-12M-6G	12	3/8	19	68.0	39.0	20.0
368PLP-12M-8G	12	1/2	24	70.0	39.0	20.0

WARNING These products can expose you to chemicals including NICKEL, which is known to the state of California to cause cancer. For more information go to www.P65Warnings.ca.gov.

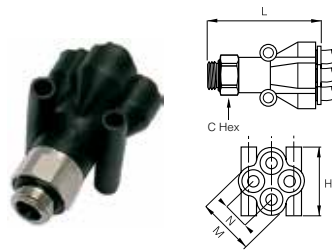

368PLPD Double Y Male Connector - BSPP

PART NO.	TUBE SIZE MM	BSPP	C HEX MM	H	L	M	N	MOUNTING HOLE DIA
368PLPD-4M-2G	4	1/8	13	25.5	41.0	21.0	10.0	3.7
368PLPD-4M-4G	4	1/4	16	25.5	40.0	21.0	10.0	3.7
368PLPD-6M-2G	6	1/8	19	31.5	52.5	26.5	12.0	3.7
368PLPD-6M-4G	6	1/4	19	31.5	53.5	26.5	12.0	3.7

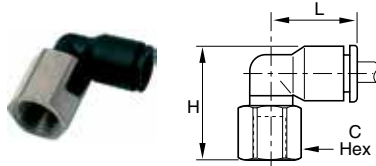

370PLP Female Elbow Swivel - NPT

PART NO.	TUBE SIZE IN	THREAD NPT	C HEX MM	L	H
370PLP-2-2	1/8	1/8	13	.57	.91
370PLP-4M-2	5/32 (4MM)	1/8	13	.55	.91
370PLP-4M-4	5/32 (4MM)	1/4	16	.55	1.08
370PLP-4-2	1/4	1/8	13	.71	1.02
370PLP-4-4	1/4	1/4	16	.71	1.18
370PLP-8M-2	5/16 (8MM)	1/8	13	.91	1.12
370PLP-8M-4	5/16 (8MM)	1/4	16	.91	1.28
370PLP-6-2	3/8	1/8	16	1.04	1.52
370PLP-6-4	3/8	1/4	16	1.04	1.52
370PLP-8-6	1/2	3/8	22	1.38	1.88

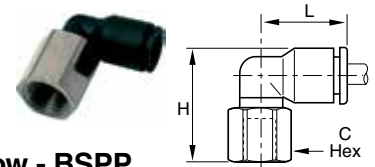

370PLP Female Elbow - BSPP

PART NO.	TUBE SIZE MM	BSPP	C HEX MM	H	L
370PLP-4M-2G	4	1/8	13	23.0	14.0
370PLP-4M-4G	4	1/4	16	27.0	14.0
370PLP-6M-2G	6	1/8	13	25.0	16.0
370PLP-6M-4G	6	1/4	16	29.0	16.0
370PLP-8M-2G	8	1/8	13	28.0	23.0
370PLP-8M-4G	8	1/4	16	32.0	23.0
370PLP-8M-6G	8	3/8	19	33.0	23.0
370PLP-10M-4G	10	1/4	16	34.5	26.5
370PLP-10M-6G	10	3/8	19	35.0	26.5
370PLP-10M-8G	10	1/2	24	41.0	26.5
370PLP-12M-4G	12	1/4	16	38.0	30.5
370PLP-12M-6G	12	3/8	19	38.5	30.5
370PLP-12M-8G	12	1/2	24	43.5	30.5

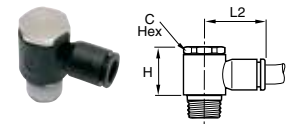

W369PLPBJ Banjo - NPT

PART NO.	TUBE SIZE IN	THREAD NPT / UNF	C HEX MM	H	L2
369PLPBJ-2-0	1/8	10-32		.79	.65
369PLPBJ-4M-0	5/32 (4MM)	10-32		.79	.65
W369PLPBJ-4M-2	5/32 (4MM)	1/8	13	.73	.73
369PLPBJ-4-0	1/4	10-32		.79	.73
W369PLPBJ-4-2	1/4	1/8	13	.73	.83
W369PLPBJ-4-4	1/4	1/4	17	.89	.91
W369PLPBJ-4-6	1/4	3/8	21	1.04	1.12
W369PLPBJ-6-4	3/8	1/4	17	.89	1.12
W369PLPBJ-6-6	3/8	3/8	21	1.04	1.20

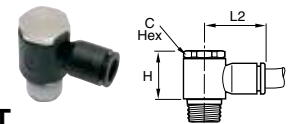

W369PLPBJ Banjo - BSPT

PART NO.	TUBE SIZE MM	BSPT	C HEX MM	H	L2
W369PLPBJ-6M-2R	6	1/8	13	18.5	20.0
W369PLPBJ-6M-4R	6	1/4	17	22.5	22.0
W369PLPBJ-8M-2R	8	1/8	13	18.5	25.0
W369PLPBJ-8M-4R	8	1/4	17	22.5	27.0
W369PLPBJ-10M-4R	10	1/4	17	22.5	29.0
W369PLPBJ-10M-6R	10	3/8	21	26.5	31.0
W369PLPBJ-12M-4R	12	1/4	21	26.5	34.5
W369PLPBJ-12M-6R	12	3/8	21	26.5	34.5

WARNING These products can expose you to chemicals including NICKEL, which is known to the state of California to cause cancer. For more information go to www.P65Warnings.ca.gov.

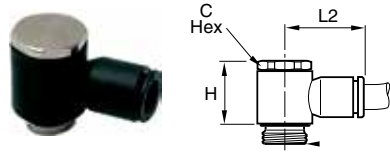

369PLPBJ Banjo - BSPP

PART NO.	TUBE SIZE MM	BSPP / METRIC	C HEX MM	H	L2
369PLPBJ-3M-M3*	3	M3X0.5		13.0	16.0
369PLPBJ-4M-M5*	4	M5X0.8		13.0	16.0
369PLPBJ-4M-2G	4	1/8	13	17.0	18.5
369PLPBJ-6M-M5*	6	M5X0.8		13.0	18.5
369PLPBJ-6M-2G	6	1/8	13	17.0	20.0
369PLPBJ-6M-4G	6	1/4	17	21.0	22.0
369PLPBJ-8M-2G	8	1/8	13	16.5	25.0
369PLPBJ-8M-4G	8	1/4	17	21.0	27.0
369PLPBJ-8M-6G	8	3/8	20	24.5	29.0
369PLPBJ-10M-4G	10	1/4	17	21.0	29.0
369PLPBJ-10M-6G	10	3/8	20	24.5	31.0
369PLPBJ-10M-8G	10	1/2	25	27.5	36.5
369PLPBJ-12M-6G	12	3/8	20	24.5	34.5
369PLPBJ-12M-8G	12	1/2	25	27.5	36.5

*With screwdriver slot

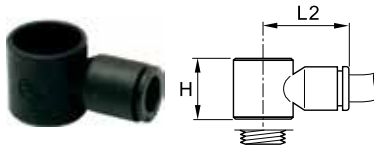

369PLPBJB Banjo Bodies

PART NO.	TUBE SIZE MM	BSPP / M5	H	L2
369PLPBJB-4M-M5	4	M5X0.8	13.0	16.0
369PLPBJB-4M-2G	4	1/8	14.5	18.5
369PLPBJB-6M-M5	6	M5X0.8	13.0	18.5
369PLPBJB-6M-2G	6	1/8	14.5	20.0
369PLPBJB-6M-4G	6	1/4	18.0	22.0
369PLPBJB-8M-2G	8	1/8	14.5	25.0
369PLPBJB-8M-4G	8	1/4	18.0	27.0
369PLPBJB-8M-6G	8	3/8	21.5	29.0
369PLPBJB-10M-4G	10	1/4	18.0	29.0
369PLPBJB-10M-6G	10	3/8	21.5	31.0
369PLPBJB-12M-6G	12	3/8	21.5	34.5

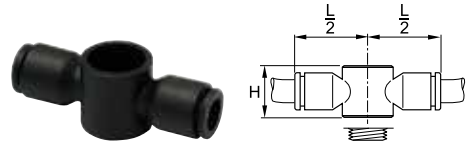

32PLPDJB Double Banjo Bodies

PART NO.	TUBE SIZE MM	BSPP / M5	H	L/2
32PLPDJB-6M-2G	6	1/8	14.4	20.0
32PLPDJB-6M-4G	6	1/4	18.0	26.0
32PLPDJB-8M-4G	8	1/4	18.0	27.0

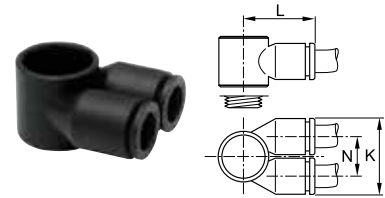

369PLPTJB Twin Banjo Bodies

PART NO.	TUBE SIZE MM	BSPP / M5	K	L	N
369PLPTJB-4M-4G	4	1/4	28.0	25.0	14.5
369PLPTJB-6M-2G	6	1/8	22.5	20.5	12.0
369PLPTJB-6M-4G	6	1/4	28.0	25.0	14.5
369PLPTJB-6M-6G	6	3/8	33.0	28.5	17.0
369PLPTJB-8M-4G	8	1/4	28.0	26.0	14.5
369PLPTJB-8M-6G	8	3/8	33.0	29.5	17.0

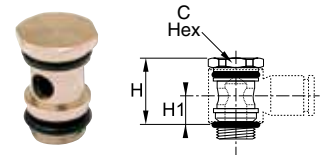

68BJB Single Banjo Bolt

PART NO.	BSPP / M5	C HEX MM	H	H1
68BJB-M5*	M5X0.8		17.0	7.5
68BJB-2G	1/8	13	17.0	7.5
68BJB-4G	1/4	17	21.0	9.5
68BJB-6G	3/8	20	24.5	11.0

*With screwdriver slot

WARNING These products can expose you to chemicals including NICKEL, which is known to the state of California to cause cancer. For more information go to www.P65Warnings.ca.gov.

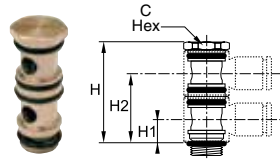

68BJBD Double Banjo Bolt

PART NO.	BSPP / M5	C HEX MM	H	H1	H2
68BJBD-M5*	M5X0.8		24.5	7.5	18.5
68BJBD-2G	1/8	13	31.0	7.5	22.0
68BJBD-4G	1/4	17	39.0	9.5	27.5
68BJBD-6G	3/8	20	46.0	11.0	32.5

*With screwdriver slot

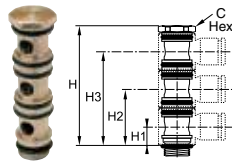

68BJBT Triple Banjo Bolt

PART NO.	BSPP	C HEX MM	H	H1	H2	H3
68BJBT-2G	1/8	13	45.5	7.5	22.0	36.0
68BJBT-4G	1/4	17	54.0	9.5	27.5	45.5
68BJBT-6G	3/8	20	67.5	11.0	32.5	54.0

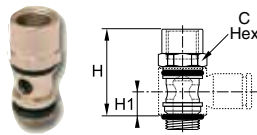

66BJB Female Threaded Banjo Bolt

PART NO.	1 BSPP / M5	2 BSPP / M5	C HEX MM	H	H1
66BJB-2G	1/8	1/8	13	24.5	7.5
66BJB-4G	1/4	1/4	17	33.0	9.5
66BJB-6G	3/8	3/8	20	37.5	11.0
66BJB-8G	1/2	1/2	25	42.0	11.5

*With screwdriver slot

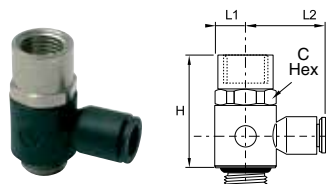

376PLPBJ Banjo with Female Bolt

PART NO.	TUBE SIZE MM	BSPP / M5	C HEX MM	H	L1	L2
376PLPBJ-4M-2G	4	1/8	13	25.5	7.0	18.5
376PLPBJ-6M-4G	6	1/4	17	33.0	9.0	22.0
376PLPBJ-8M-6G	8	3/8	20	37.5	11	29.0

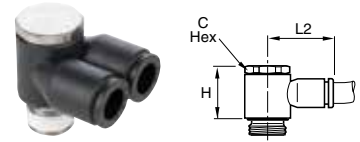

W369PLPTJ Twin Banjo - NPT

PART NO.	TUBE SIZE IN	THREAD NPT / UNF	C HEX MM	H	L2
369PLPTJ-4M-0	5/32 (4MM)	10-32		.63	.61
W369PLPTJ-4M-2	5/32 (4MM)	1/8	13	.73	.73
W369PLPTJ-4-2	1/4	1/8	13	.73	.73
W369PLPTJ-4-4	1/4	1/4	17	.89	1.04
W369PLPTJ-6-4	3/8	1/4	21	1.04	1.22
W369PLPTJ-6-6	3/8	3/8	21	1.04	1.22

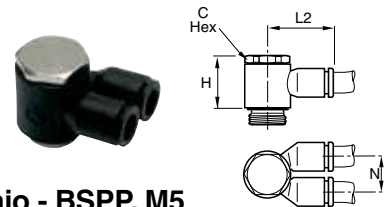

369PLPTJ Twin Banjo - BSPP, M5

PART NO.	TUBE SIZE MM	BSPP / M5	C HEX MM	H	L2	N
369PLPTJ-4M-M5	4	M5X0.8		13.0	16.0	9.0
369PLPTJ-4M-2G	4	1/8	13	16.5	18.5	11.5
369PLPTJ-6M-2G	6	1/8	13	16.5	18.5	11.5
369PLPTJ-6M-4G	6	1/4	17	21.0	27.0	14.5
369PLPTJ-8M-4G	8	1/4	17	21.0	27.0	14.5
369PLPTJ-8M-6G	8	3/8	20	24.5	31.0	17.0
369PLPTJ-10M-6G	10	3/8	20	24.5	31.0	17.0

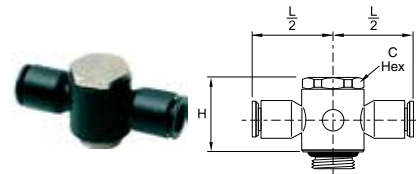

32PLPDJ Double Banjo - BSPP, M5

PART NO.	TUBE SIZE MM	BSPP / M5	C HEX MM	H	L/2
32PLPDJ-4M-M5	4	M5X0.8		13.0	16.0
32PLPDJ-6M-2G	6	1/8	13	17.0	20.0
32PLPDJ-6M-4G	6	1/4	17	21.0	26.5
32PLPDJ-8M-4G	8	1/4	17	21.0	27.0
32PLPDJ-8M-6G	8	3/8	20	24.5	30.5

WARNING These products can expose you to chemicals including NICKEL, which is known to the state of California to cause cancer. For more information go to www.P65Warnings.ca.gov.



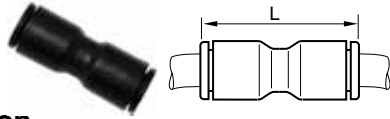

32PLP Equal Union

PART NO.	TUBE SIZE IN	L
32PLP-2	1/8	.97
32PLP-3	3/16	1.44
32PLP-4	1/4	1.16
32PLP-6	3/8	1.65
32PLP-8	1/2	2.17

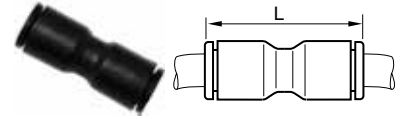

32PLP Converter

PART NO.	TUBE SIZE IN	TUBE SIZE MM	L
32PLP-6M-4	1/4	6	1.18
32PLP-10M-6	3/8	10	1.99
32PLP-12M-8	1/2	12	2.25

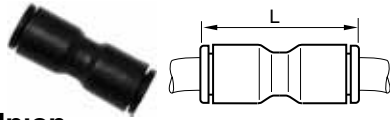

32PLP Unequal Union

PART NO.	1 TUBE SIZE IN	2 TUBE SIZE IN	L
32PLP-4M-2	5/32 (4M)	1/8	0.96
32PLP-4M-4	5/32 (4M)	1/4	1.16
32PLP-4-2	1/4	1/8	1.32
32PLP-4-8M	1/4	5/16 (8M)	1.44
32PLP-6-4	3/8	1/4	1.61
32PLP-6-8	3/8	1/2	2.17



365PLP Union Elbow

PART NO.	TUBE SIZE IN	L
365PLP-2	1/8	.71
365PLP-3	3/16	1.07
365PLP-4	1/4	.93
365PLP-6	3/8	1.33
365PLP-8	1/2	1.38

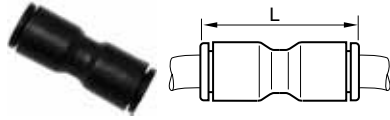

32PLP Union

PART NO.	TUBE SIZE MM	L
32PLP-3M	3	25.0
32PLP-4M	4	25.0
32PLP-6M	6	28.5
32PLP-8M	8	38.0
32PLP-10M	10	42.0
32PLP-12M	12	50.5
32PLP-14M	14	56.0
32PLP-16M	16	60.5

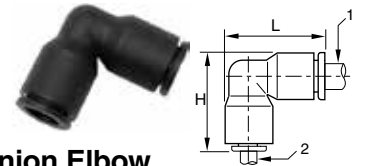

365PLP Unequal Union Elbow

PART NO.	1 TUBE SIZE IN	2 TUBE SIZE IN	L	H
365PLP-2-4	1/8	1/4	.93	.93
365PLP-4M-4	5/32 (4M)	1/4	.93	.93
365PLP-6-4	3/8	1/4	1.33	1.30
365PLP-6-8	3/8	1/2	1.81	1.81

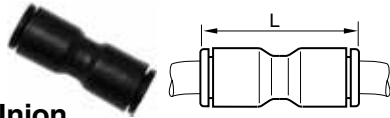

32PLP Unequal Union

PART NO.	1 TUBE SIZE MM	2 TUBE SIZE MM	L
32PLP-3M-4M	3	4	25.0
32PLP-6M-4M	6	4	28.0
32PLP-8M-4M	8	4	28.0
32PLP-8M-6M	8	6	38.0
32PLP-10M-6M	10	6	42.0
32PLP-10M-8M	10	8	42.0
32PLP-12M-8M	12	8	50.5
32PLP-12M-10M	12	10	50.5
32PLP-12M-14M	12	14	56.0
32PLP-12M-16M	16	12	61.0

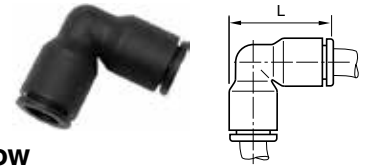

365PLP Union Elbow

PART NO.	TUBE SIZE MM	L
365PLP-4M	4	19.0
365PLP-6M	6	22.5
365PLP-8M	8	29.5
365PLP-10M	10	34.5
365PLP-12M	12	40.5
365PLP-14M	14	46.5
365PLP-16M	16	52.0

WARNING These products can expose you to chemicals including NICKEL, which is known to the state of California to cause cancer. For more information go to www.P65Warnings.ca.gov.



365PLP Unequal Union Elbow

PART NO.	1 TUBE SIZE MM	2 TUBE SIZE MM	L
365PLP-4M-6M	4	6	22.5
365PLP-6M-8M	6	8	29.5
365PLP-8M-10M	8	10	34.5
365PLP-10M-12M	10	12	40.5

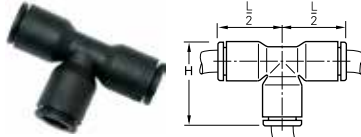

364PLP Union Tee

PART NO.	TUBE SIZE IN	L/2	H
364PLP-2	1/8	.57	.75
364PLP-3	3/16	.85	1.07
364PLP-4	1/4	.71	.92
364PLP-6	3/8	1.02	1.34
364PLP-8	1/2	1.38	1.81

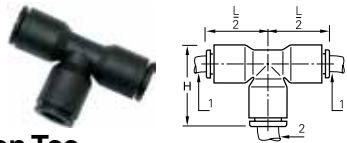

364PLP Unequal Union Tee

PART NO.	1 TUBE SIZE IN	2 TUBE SIZE IN	L/2	H
364PLP-2-4	1/8	1/4	.71	.93
364PLP-4M-4	5/32 (4MM)	1/4	.71	.93
364PLP-4-2	1/4	1/8	.73	.93
364PLP-4-4M	1/4	5/32 (4MM)	.73	.93
364PLP-4-6	1/4	3/8	.96	1.32
364PLP-6-4	3/8	1/4	1.00	1.28
364PLP-6-8	3/8	1/2	1.38	1.81
364PLP-8-4	1/2	1/4	1.38	1.81
364PLP-8-6	1/2	3/8	1.38	1.81

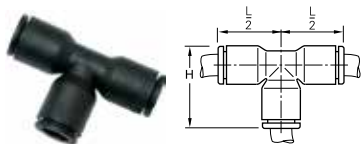

364PLP Union Tee

PART NO.	TUBE SIZE MM	H	L/2
364PLP-3M	3	19.0	14.5
364PLP-4M	4	19.0	14.5
364PLP-6M	6	23.5	18.0
364PLP-8M	8	29.5	23.0
364PLP-10M	10	34.5	26.5
364PLP-12M	12	40.5	31.0
364PLP-14M	14	46.0	35.5
364PLP-16M	16	52.0	39.0



364PLP Unequal Union Tee

PART NO.	1 TUBE SIZE MM	2 TUBE SIZE MM	H	L/2
364PLP-4M-6M	4	6	22.5	17.5
364PLP-6M-4M	6	4	22.5	17.5
364PLP-6M-8M	6	8	29.5	23.0
364PLP-8M-6M	8	6	29.5	23.0
364PLP-8M-10M	8	10	34.5	26.5
364PLP-10M-12M	10	12	34.5	26.5
364PLP-10M-8M	10	8	40.5	31.0
364PLP-12M-10M	12	10	40.5	31.0
364PLP-14M-8M	14	8	46.0	35.5
364PLP-16M-12M	16	12	39.0	

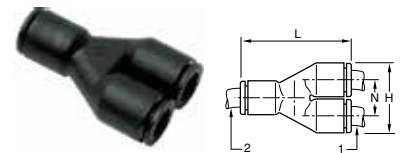

362PLP Union Y

PART NO.	1 TUBE SIZE IN	2 TUBE SIZE IN	L	H	N
362PLP-2	1/8	1/8	1.12	.69	.35
362PLP-2-4	1/8	1/4	1.42	.87	.45
362PLP-4M-4	5/32 (4MM)	1/4	1.42	.87	.45
362PLP-4	1/4	1/4	1.42	.87	.45
362PLP-4-6	1/4	3/8	2.02	1.30	.67
362PLP-6	3/8	3/8	2.09	1.30	.67

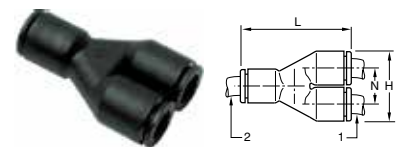

362PLP Union Y

PART NO.	1 TUBE SIZE MM	2 TUBE SIZE (M)	H	L	N
362PLP-4M	4	4	17.5	28.5	9.0
362PLP-6M	6	6	21.5	35.0	11.0
362PLP-8M	8	8	28.0	45.0	14.5
362PLP-10M	10	10	33.0	53.0	17.0
362PLP-4M-6M	4	6	17.5	33.0	9.0
362PLP-6M-8M	6	8	22.5	41.0	11.5
362PLP-8M-10M	8	10	28.0	47.0	14.5
362PLP-10M-12M	10	12	33.0	57.0	17.0

WARNING These products can expose you to chemicals including NICKEL, which is known to the state of California to cause cancer. For more information go to www.P65Warnings.ca.gov.



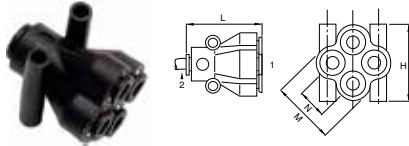

362PLPD Double Y Connector

PART NO.	1 TUBE SIZE IN	2 TUBE SIZE IN	H	L	M	N	MOUNTING HOLE DIA.
362PLPD-4M-4	5/32 (4MM)	1/4	1.00	1.18	.83	.39	.15

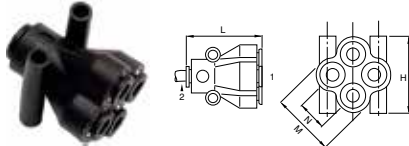

362PLPD Double Y Connector

PART NO.	1 TUBE SIZE MM	2 TUBE SIZE MM	H	L	M	N	MOUNTING HOLE DIA.
362PLPD-4M	4	4	25.5	30.5	21.0	10.0	3.7
362PLPD-6M	6	6	31.5	37.5	26.5	12.0	3.7
362PLPD-4M-6M	4	6	25.5	30.5	21.0	10.0	3.7
362PLPD-6M-8M	6	8	31.5	38.0	26.5	12.0	3.7



32PLPBH Bulkhead Union

PART NO.	TUBE SIZE IN	C HEX MM	K MAX	L1	L2	BULKHEAD THREAD	BULKHEAD HOLE DIA.
32PLPBH-2	1/8	13	.22	.37	.61	M10 X 1	12MM
32PLPBH-4	1/4	16	.35	.37	.81	M15 X 1	16MM
32PLPBH-6	3/8	22	.57	.51	1.18	M18 X 1.5	24MM
32PLPBH-8	1/2	29	.81	.67	1.61	M25 X 1.5	26MM



32PLPBH Bulkhead Union

PART NO.	TUBE SIZE MM	C HEX MM	K MAX	L1	L2	BULKHEAD THREAD	BULKHEAD HOLE DIA.
32PLPBH-4M	4	13	5.5	15.0	10.0	M12 X 1	12MM
32PLPBH-6M	6	15	8.5	18.0	10.5	M14 X 1	14MM
32PLPBH-8M	8	18	14.5	25.0	13.5	M16 X 1	16MM
32PLPBH-10M	10	22	14.5	27.5	15.5	M22 X 1.5	22MM
32PLPBH-12M	12	26	18.5	33.0	18.0	M24 X 1.5	24MM
32PLPBH-14M	14	29	20.5	37.5	20.5	M26 X 1.5	26MM

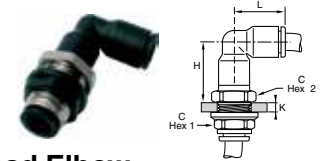

365PLPBH Equal Bulkhead Elbow

PART NO.	TUBE SIZE IN	C1 HEX	C2 HEX	K MAX	H	L	BULKHEAD THREAD	BHD HOLE DIA.
365PLPBH-2	1/8	13	13	.28	.71	.57	M10 X 1	10MM
365PLPBH-4M	5/32(4MM)		13	.26	.83	.67	M12 X 1	12MM
365PLPBH-4	1/4	18	17	.32	.87	.71	M15 X 1	15MM
365PLPBH-8M	5/16(8MM)		18	.31	1.22	.94	M16 X 1	16MM
365PLPBH-6	3/8	22	22	.33	1.08	1.00	M18 X 1.5	18MM
365PLPBH-8	1/2	29	27	.41	1.54	1.38	M25 X 1.5	25MM

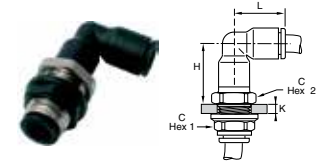

365PLPBH Equal Bulkhead Elbow

PART NO.	TUBE SIZE MM	C1 HEX	C2 HEX	K MAX	H	L	BULKHEAD THREAD	BULKHEAD HOLE DIA.
365PLPBH-4M	4	13	13	6.5	21.0	17.0	M12 X 1	12MM
365PLPBH-6M	6	15	15	7.0	24.5	19.5	M14 X 1	14MM
365PLPBH-8M	8	18	18	8.0	31.0	24.0	M16 X 1	16MM
365PLPBH-10M	10	22	22	8.5	36.0	28.0	M22 X 1.5	22MM
365PLPBH-12M	12	26	26	8.5	42.0	33.0	M24 X 1.5	24MM

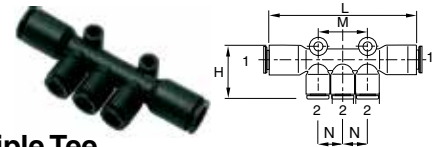

24PLP Multiple Tee

PART NO.	1 TUBE SIZE IN	2 TUBE SIZE IN	H	L	M	N	MTG HOLE DIA.
24PLP-4-4M	1/4	5/32(4MM)	0.97	2.81	.90	.45	.17
24PLP-4-4	1/4	1/4	1.22	3.14	1.21	.61	.17
24PLP-6-4	3/8	1/4	1.34	3.21	1.22	.61	.17

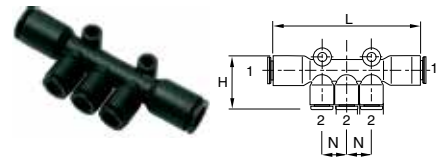

24PLP Multiple Tee

PART NO.	1 TUBE SIZE MM	2 TUBE SIZE (M)	H	L	N	MOUNTING HOLE DIA.
24PLP-6M-4M	6	4	24.5	74	11.5	4.2
24PLP-8M-4M	8	4	24.5	74	11.5	4.2
24PLP-8M-6M	8	6	24.5	74	11.5	4.2
24PLP-10M-6M	10	6	36.0	81	15.5	4.2
24PLP-10M-8M	10	8	36.0	81	15.5	4.2

WARNING These products can expose you to chemicals including NICKEL, which is known to the state of California to cause cancer. For more information go to www.P65Warnings.ca.gov.

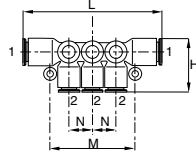

24PLPD Double Multiple Tee

PART NO.	1 TUBE SIZE IN	2 TUBE SIZE IN	H	L	M	N	MOUNTING HOLE DIA.
24PLPD-4-4M	1/4	5/32(4MM)	.73	2.84	1.69	.45	.17
24PLPD-4-4	1/4	1/4	.73	2.84	1.69	.45	.17
24PLPD-6-4	3/8	1/4	.91	3.31	2.05	.57	.17

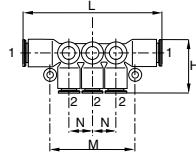

24PLPD Double Multiple Tee

PART NO.	1 TUBE SIZE MM	2 TUBE SIZE MM	H	L	M	N	MOUNTING HOLE DIA.
24PLPD-6M-4M	6	4	18.5	72.0	43.0	11.5	4.2
24PLPD-8M-4M	8	4	18.5	73.0	43.0	11.5	4.2
24PLPD-8M-6M	8	6	18.5	73.0	43.0	11.5	4.2
24PLPD-10M-6M	10	6	23.0	84.0	52.0	14.5	4.2
24PLPD-10M-8M	10	8	23.5	84.0	52.0	14.5	4.2

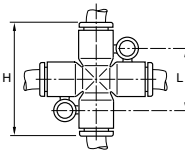

347PLP Equal Cross

PART NO.	TUBE SIZE IN	H	L	MOUNTING HOLE DIA.
347PLP-4	1/4	1.40	.79	.17

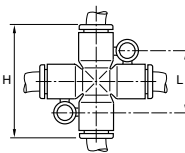

347PLP Equal Cross

PART NO.	TUBE SIZE MM	H	L	MOUNTING HOLE DIA.
347PLP-4M	4	36	20.0	4.2
347PLP-6M	6	36	20.0	4.2
347PLP-8M	8	46	22.5	4.2

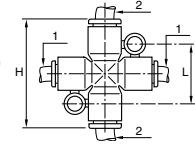

347PLP Unequal Cross

PART NO.	1 TUBE SIZE MM	2 TUBE SIZE MM	H	L	MOUNTING HOLE DIA.
347PLP-4M-6M	4	6	36	20.0	4.2
347PLP-6M-4M*	6	4	36	20.0	4.2
347PLP-6M-8M	6	8	46	22.5	4.2
347PLP-8M-6M*	8	6	46	22.5	4.2

*This model provides 3 outlines of "TUBE1" and 1 outlet of "TUBE 2".

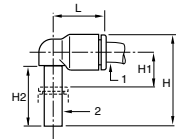

369PLPSP Plug-In Elbow

PART NO.	1 TUBE SIZE IN	2 TUBE SIZE IN	H	H1	H2	L
369PLPSP-2	1/8	1/8	.92	.31	.64	.57
369PLPSP-4M-4	5/32(4MM)	1/4	1.08	.30	.71	.71
369PLPSP-4	1/4	1/4	1.20	.43	.83	.73
369PLPSP-4-6	1/4	3/8	1.52	.35	.96	.98
369PLPSP-6	3/8	3/8	1.52	.35	.96	1.02
369PLPSP-8	1/2	1/2	2.00	.51	1.12	1.38

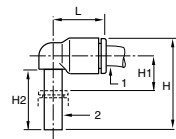

369PLPSP Plug-In Elbow

PART NO.	1 TUBE SIZE MM	2 TUBE SIZE MM	H	H1	H2	L
369PLPSP-4M	4	4	23.0	6.0	15.5	14.0
369PLPSP-6M	6	6	26.5	7.0	17.0	16.0
369PLPSP-8M	8	8	33.5	8.0	21.5	23.0
369PLPSP-10M	10	10	39.0	9.5	24.5	23.5
369PLPSP-12M	12	12	44.5	10.0	27.5	31.0
369PLPSP-4M-6M	4	6	26.5	7.0	17.0	16.0
369PLPSP-6M-4M	6	4	24.5	7.0	15.5	16.0
369PLPSP-6M-8M	6	8	33.5	8.0	21.5	22.0
369PLPSP-8M-10M	8	10	39.0	8.5	24.5	26.5
369PLPSP-10M-12M	10	12	44.5	10.0	27.5	31.0

WARNING These products can expose you to chemicals including NICKEL, which is known to the state of California to cause cancer. For more information go to www.P65Warnings.ca.gov.





369PLPSPX Extended Plug-In Elbow

PART NO.	1 TUBE SIZE IN	2 TUBE SIZE IN	H	H1	H2	L
369PLPSPX-2	1/8	1/8	1.26	.65	.98	.57
369PLPSPX-4	1/4	1/4	1.56	.77	1.18	.71
369PLPSPX-6	3/8	3/8	2.19	1.02	1.63	1.02

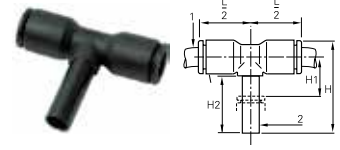

372PLPSP Plug-In Branch Tee

PART NO.	1 TUBE SIZE IN	2 TUBE SIZE IN	H	H1	H2	L/2
372PLPSP-2	1/8	1/8	.95	.26	.59	.57
372PLPSP-4	1/4	1/4	.98	.43	.77	.73
372PLPSP-6	3/8	3/8	1.61	.35	.96	.98
372PLPSP-8	1/2	1/2	2.01	.51	1.12	1.38



369PLPSPX Extended Plug-In Elbow

PART NO.	1 TUBE SIZE MM	2 TUBE SIZE MM	H	H1	H2	L
369PLPSPX-4M	4	4	32.5	15.5	25.0	14.0
369PLPSPX-6M	6	6	38.5	19.0	29.0	16.0
369PLPSPX-8M	8	8	49.0	23.5	37.0	23.0
369PLPSPX-10M	10	10	56.0	26.5	41.5	26.5
369PLPSPX-12M	12	12	62.5	28.0	45.5	31.0
369PLPSPX-4M-6M	4	6	38.5	19.0	29.0	16.0
369PLPSPX-6M-8M	6	8	49.0	23.5	37.0	23.0
369PLPSPX-8M-10M	8	10	56.0	26.5	41.5	26.5
369PLPSPX-10M-12M	10	12	62.5	28.0	45.5	31.0

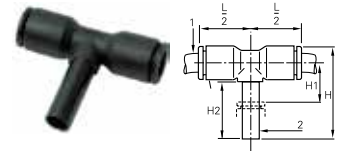

372PLPSP Plug-In Branch Tee

PART NO.	1 TUBE SIZE MM	2 TUBE SIZE MM	H	H1	H2	L/2
372PLPSP-4M	4	4	23.0	6.0	15.5	14.5
372PLPSP-6M	6	6	26.5	7.0	17.0	16.0
372PLPSP-8M	8	8	33.5	8.0	21.5	23.0
372PLPSP-10M	10	10	39.0	9.5	24.5	26.5
372PLPSP-12M	12	12	44.5	10.0	27.5	31.0
372PLPSP-4M-6M	4	6	26.5	7.0	17.0	16.0
372PLPSP-6M-8M	6	8	33.5	8.0	21.5	23.0
372PLPSP-8M-10M	8	10	39.0	9.5	24.5	26.5
372PLPSP-10M-12M	10	12	44.5	10.0	27.5	31.0

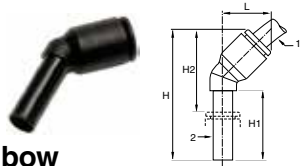

379PLPSP 45° Plug-In Elbow

PART NO.	1 TUBE SIZE IN	2 TUBE SIZE IN	H	H1	H2	L
379PLPSP-2	1/8	1/8	1.14	.59	.69	.47
379PLPSP-4	1/4	1/4	1.44	.71	.87	.57
379PLPSP-6	3/8	3/8	2.00	.96	1.16	.91

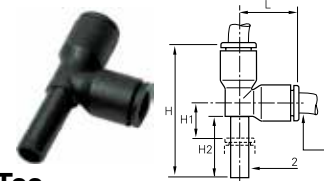

371PLPSP Plug-In Run Tee

PART NO.	1 TUBE SIZE IN	2 TUBE SIZE IN	H	H1	H2	L
371PLPSP-4	1/4	1/4	1.69	.43	.83	.73
371PLPSP-6	3/8	3/8	2.23	.33	.96	1.00
371PLPSP-8	1/2	1/2	2.86	.51	1.12	1.38

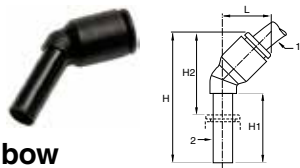

379PLPSP 45° Plug-In Elbow

PART NO.	1 TUBE SIZE MM	2 TUBE SIZE MM	H	H1	H2	L
379PLPSP-4M	4	4	33.5	19.0	21.0	13.0
379PLPSP-6M	6	6	39.0	21.0	25.0	14.5
379PLPSP-8M	8	8	44.0	21.5	25.5	19.5
379PLPSP-10M	10	10	53.0	27.0	32.5	23.0
379PLPSP-12M	12	12	58.5	27.5	34.0	26.5

WARNING These products can expose you to chemicals including NICKEL, which is known to the state of California to cause cancer. For more information go to www.P65Warnings.ca.gov.

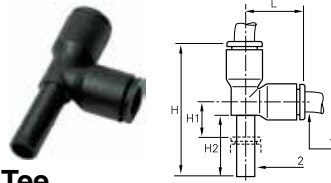

371PLPSP Plug-In Run Tee

PART NO.	1 TUBE SIZE MM	2 TUBE SIZE MM	H	H1	H2	L
371PLPSP-4M	4	4	33.0	6.0	15.5	14.5
371PLPSP-6M	6	6	38.5	7.0	17.0	17.5
371PLPSP-8M	8	8	49.0	8.0	21.5	23.0
371PLPSP-10M	10	10	57.0	10.5	24.5	26.5
371PLPSP-12M	12	12	65.5	10.5	27.5	31.0
371PLPSP-4M-6M	4	6	10.5	7.0	17.0	17.5
371PLPSP-6M-8M	6	8	13.5	8.0	21.5	23.0
371PLPSP-8M-10M	8	10	16.0	10.5	24.5	26.5
371PLPSP-10M-12M	10	12	19.0	10.5	27.5	31.0

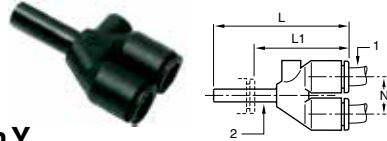

362PLPSP Plug-In Y

PART NO.	1 TUBE SIZE IN	2 TUBE SIZE IN	L	L1	N
362PLPSP-2	1/8	1/8	1.36	1.00	.35
362PLPSP-4	1/4	1/4	1.60	1.02	.45
362PLPSP-6	3/8	3/8	2.23	1.42	.67

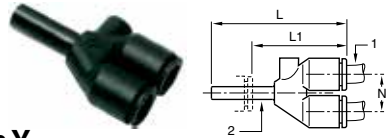

362PLPSP Plug-In Y

PART NO.	1 TUBE SIZE MM	2 TUBE SIZE MM	L	L1	N
362PLPSP-4M	4	4	34.0	21.5	9.0
362PLPSP-6M	6	6	39.5	25.5	11.0
362PLPSP-8M	8	8	50.5	32.0	14.5
362PLPSP-10M	10	10	57.5	36.0	17.0
362PLPSP-12M	12	12	66.0	41.0	20.0
362PLPSP-4M-6M	4	6	35.5	21.5	9.0
362PLPSP-6M-8M	6	8	44.0	25.5	11.0
362PLPSP-8M-10M	8	10	53.5	32.0	14.5
362PLPSP10M-12M	10	12	60.0	35.0	17.0

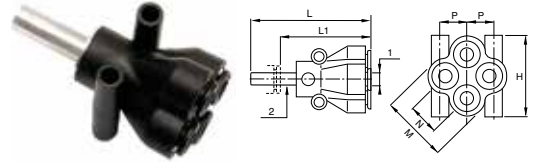

362PLPDSP Plug-In Multiple Y

PART NO.	1 TUBE SIZE MM	2 TUBE SIZE MM	H	L	L1	M	N
362PLPDSP-4M-6M	4	6	25.5	45.0	31.0	21.0	10.0
362PLPDSP-4M-8M	4	8	25.5	49.5	31.0	21.0	10.0
362PLPDSP-6M-8M	6	8	31.5	59.5	41.0	26.5	12.0

*Aluminum tail piece

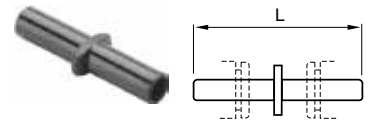

63PLP Double Male Union

PART NO.	TUBE SIZE IN	L
63PLP-4	1/4	1.52
63PLP-6	3/8	2.03

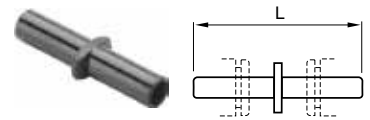

63PLP Double Male Union

PART NO.	TUBE SIZE MM	L
63PLP-4M	4	34 1/2
63PLP-6M	6	38 1/2
63PLP-8M	8	41
63PLP-10M	10	51 1/2
63PLP-12M	12	60
63PLP-14M	14	69 1/2

WARNING These products can expose you to chemicals including NICKEL, which is known to the state of California to cause cancer. For more information go to www.P65Warnings.ca.gov.

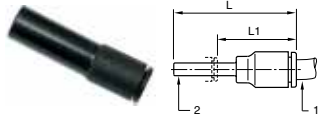

67PLP Tube Reducer

PART NO.	1 TUBE SIZE IN	2 TUBE SIZE IN	L	L1
67PLP-2-4M	1/8	5/32 (4M)	1.79	1.32
67PLP-2-3	1/8	3/16	1.79	1.14
67PLP-2-4	1/8	1/4	1.79	1.22
67PLP-4M-3	5/32 (4MM)	3/16	1.48	.83
67PLP-4M-4	5/32 (4MM)	1/4	1.48	.91
67PLP-4M-6	5/32 (4MM)	3/8	1.61	.81
67PLP-3-8M	3/16	5/16 (8M)	1.79	1.06
67PLP-3-4	3/16	1/4	1.79	1.22
67PLP-4-8M	1/4	5/16 (8M)	1.61	.89
67PLP-4-6	1/4	3/8	1.61	.81
67PLP-4-8	1/4	1/2	1.97	.98
67PLP-8M-6	5/16 (8MM)	3/8	1.93	1.12
67PLP-8M-8	5/16 (8MM)	1/2	2.01	1.02
67PLP-6-8	3/8	1/2	2.01	1.04

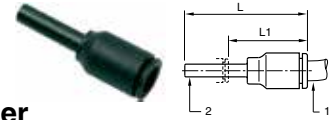

32PLPSP Tube Expander

PART NO.	1 TUBE SIZE MM	2 TUBE SIZE MM	L	L1
32PLPSP-6M-4M	6	4	35.0	23.0
32PLPSP-8M-6M	8	6	45.0	31.5
32PLPSP-10M-8M	10	8	42.5	21.0
32PLPSP-12M-10M	12	10	49.0	24.5

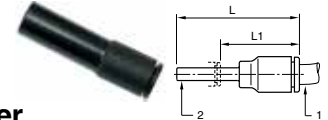

32PLPSP Tube Converter

PART NO.	1 TUBE SIZE MM	2 TUBE SIZE IN	L	L1
32PLPSP-4M-2	4M	1/8	1.61	1.16
32PLPSP-8M-4	8M	1/4	1.58	1.00

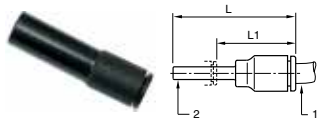

67PLP Tube Reducer

PART NO.	1 TUBE SIZE MM	2 TUBE SIZE MM	L	L1
67PLP-4M-6M	4	6	37.5	23.5
67PLP-4M-8M	4	8	37.5	19.0
67PLP-6M-8M	6	8	36.0	20.5
67PLP-4M-10M	4	10	44.0	22.5
67PLP-6M-10M	6	10	38.0	17.5
67PLP-8M-10M	8	10	49.0	28.5
67PLP-6M-12M	6	12	46.0	23.0
67PLP-8M-12M	8	12	49.0	24.5
67PLP-10M-14M	10	14	58.5	33.5
67PLP-12M-14M	12	14	58.5	33.5
67PLP-6M-14M	6	14	48.0	23.0
67PLP-8M-14M	8	14	48.0	23.0



639PLP Plug Inch

PART NO.	TUBE SIZE	L
639PLP-2	1/8	1.30
639PLP-3	3/16	1.36
639PLP-4	1/4	1.44
639PLP-6	3/8	1.67
639PLP-8	1/2	1.91

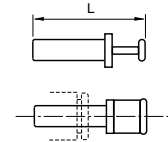

639PLP Plug Metric

PART NO.	TUBE SIZE	L
639PLP-3M	3	25
639PLP-4M	4	30
639PLP-6M	6	33
639PLP-8M	8	33
639PLP-10M	10	42
639PLP-12M	12	45
639PLP-14M	14	49
639PLP-16M*	16	57

* Nickel Plated Brass

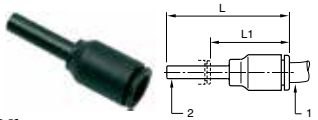

32PLPSP Tube Expander

PART NO.	1 TUBE SIZE IN	2 TUBE SIZE IN	L	L1
32PLPSP-4-2	1/4	1/8	1.61	1.16
32PLPSP-4-6M	1/4	6M	1.75	1.02
32PLPSP-4-4M	1/4	5/32 (4M)	1.61	1.14
32PLPSP-4-3	1/4	3/16	1.61	1.00
32PLPSP-6-4	3/8	1/4	1.58	1.00

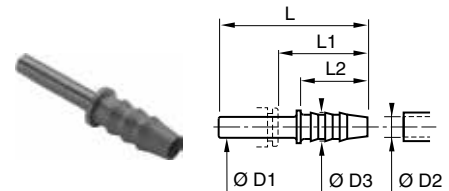

322PLPSP Barbed Connector

PART NO.	OD 1	OD 2	OD 3	L	L1	L2
322PLPSP-4M-2	5/32(4MM)	.120	.20	1.46	.98	.67
322PLPSP-4M-5M	5/32(4MM)	.200	.28	1.46	.98	.67
322PLPSP-4-3*	1/4	3/16		1.65	1.00	
322PLPSP-8M-4	5/16(8MM)	.250	.34	1.55	.83	.67
322PLPSP-8M-8M	5/16(8MM)	.320	.39	1.75	1.02	.87
322PLPSP-6-8M	3/8	.320	.39	1.97	1.16	.87
322PLPSP-8-6*	1/2	.375	.57	2.28	1.34	.87

*Nickel-plated brass. Dimensions for OD2 are I.D. of the tube.

WARNING These products can expose you to chemicals including NICKEL, which is known to the state of California to cause cancer. For more information go to www.P65Warnings.ca.gov.

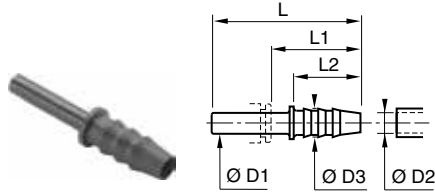

322PLPSP Barbed Connector

PART NO.	OD 1	OD 2	OD 3	L	L1	L2
322PLPSP-4M-3M	4	3.2	5.0	37.0	25.0	17.0
322PLPSP-4M-5M	4	5.0	7.0	37.0	25.0	17.0
322PLPSP-6M-5M	6	5.0	7.0	39.0	25.0	17.0
322PLPSP-8M-6M	8	6.3	8.5	39.5	21.0	17.0
322PLPSP-8M-8M	8	8.0	10.0	44.5	26.0	22.0
322PLPSP-10M-6M	10	6.3	8.0	45.0	24.5	17.0
322PLPSP-10M-8M	10	8.0	10.0	50.0	29.5	22.0
322PLPSP-12M-8M	12	8.0	10.0	50.0	26.0	22.0
322PLPSP-12M-10M	12	10.0	12.0	48.5	25.5	22.5
322PLPSP-12M-12M	12	12.5	14.5	57.0	34.0	22.5
322PLPSP-14M-12M	14	12.5	14.5	59.5	34.5	22.5

*Nickel-plated brass. Dimensions for OD2 are I.D. of the tube.

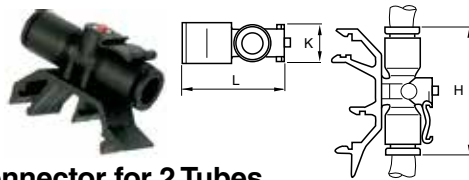

32PLPRC Connector for 2 Tubes

PART NO.	TUBE SIZE IN	H	K	L
32PLPRC-4	1/4	1.44	.47	1.18

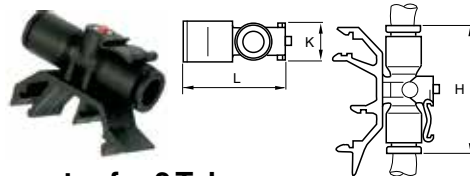

32PLPRC Connector for 2 Tubes

PART NO.	TUBE SIZE MM	H	K	L
32PLPRC-4M	4	36.5	11.0	39.5
32PLPRC-6M	6	36.5	11.0	39.5
32PLPRC-8M	8	46.0	13.0	44.5

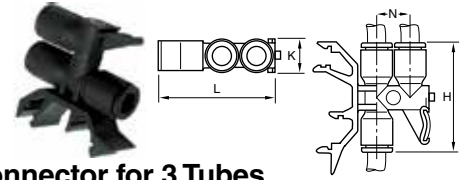

32PLPDRC Connector for 3 Tubes

PART NO.	TUBE SIZE MM	H	K	L	N
32PLPDRC-4M	4	36.5	11.0	39.5	
32PLPDRC-6M	6	36.5	11.0	39.5	
32PLPDRC-8M	8	46.0	13.0	14.5	

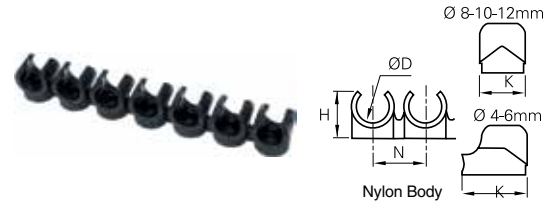

Clip Strips for Tubing and Fittings

PART NO.	D TUBE	LF3000 TO BE CLIPPED	H MM	K MM	N MM	NO. PER STRIP
CLIP 04 00	5/32, 4MM	-	9	13.5	10.5	8
CLIP 06 00	1/4, 3/16, 6MM	-	10.5	13	10.5	8
CLIP 08 00	5/16, 8MM	5/32, 4MM	12.5	10.5	12	7
CLIP 10 00	3/8, 10MM	1/4, 6MM	14	12	15	6
CLIP 12 00	1/2, 12MM		16.5	14	16.5	5
CLIP 14 00	14MM	5/16, 8MM	18	16	20.5	4

Clip strips come complete with screws of .375 inches in length.

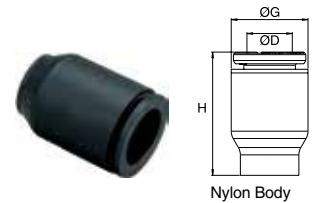

3151 End Caps

PART NO.	D IN	G MM	H MM
3151 53 00	1/8	.33	.55
3151 04 00	5/32	.33	.55
3151 56 00	1/4	.41	.64
3151 08 00	5/16	.53	.86
3151 60 00	3/8	.53	.86

3151 End Caps

PART NO.	D MM	G MM	H MM
3151 04 00	4	8.5	14.7
3151 06 00	6	10.5	16.9
3151 08 00	8	13.5	21.9
3151 10 00	10	16	22.2
3151 12 00	12	19	27.7

WARNING These products can expose you to chemicals including NICKEL, which is known to the state of California to cause cancer. For more information go to www.P65Warnings.ca.gov.

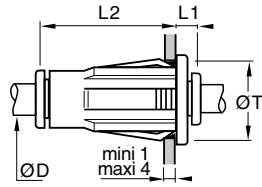

32PLPBHP Plug-in Bulkhead Union

PART NO.	TUBE SIZE IN	L1	L2	ØT
32PLPBHP-4M	5/32 (4MM)	.26	1.080	.62
32PLPBHP-4	1/4	.26	1.240	.75
32PLPBHP-8M	5/16 (8MM)	.30	1.280	.87
32PLPBHP-6	3/8	.30	1.630	1.12
32PLPBHP-8	1/2	.30	1.710	1.25

Minimum distance between fittings.
Diameter of fixing hole.

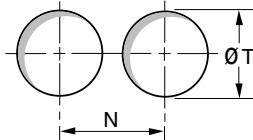

Fixing Hole

D		5/32	1/4	5/16	3/8	1/2
T	inches	5/8"	3/4"	7/8"	1 1/8"	1 1/4"
	mm	15.87	19.05	22.22	28.57	31.75
N	in	.89	1.00	1.08	1.34	1.50

Tolerance T: +0.3 -0.1

Installation

1. Mark out the fixing hole
2. Make hole in panel
3. Simply push the fitting into place
4. To complete the installation
5. To identify circuits simply remove the black release button and replace with colored one

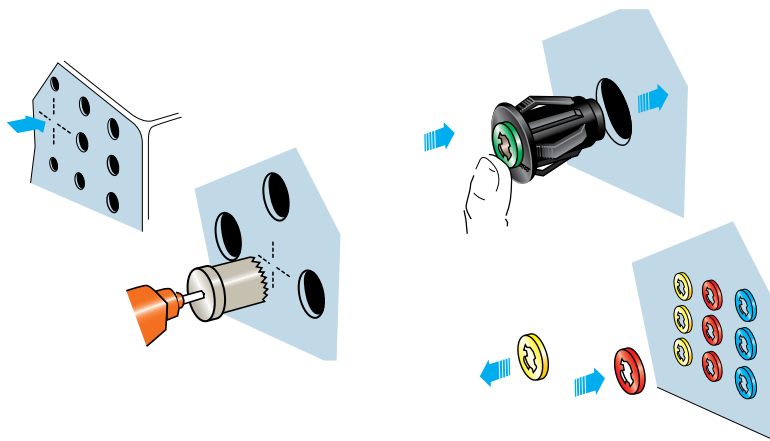

3110 - 3330 Caps Manual Release Button - Inch

TUBE O.D.	WHITE PART NO.	BLACK PART NO.	GREEN PART NO.	RED PART NO.	BLUE PART NO.	YELLOW PART NO.
1/8	3110 53 00	-	3110 53 02	3110 53 03	3110 53 04	3110 53 05
5/32	3110 04 00	3330 04 01	3110 04 02	3110 04 03	3110 04 04	3110 04 05
3/16	3330 55 00	3330 55 01	3330 55 02	3330 55 03	3330 55 04	3330 55 05
1/4	3110 56 00	3330 56 01	3110 56 02	3110 56 03	3110 56 04	3110 56 05
5/16	3110 08 00	-	3110 08 02	3110 08 03	3110 08 04	3110 08 05
3/8	3110 60 00	-	3110 60 02	3110 60 03	3110 60 04	3110 60 05
1/2	3110 62 00	3330 62 01	3110 62 02	3110 62 03	3110 62 04	3110 62 05

3110 - 3330 Caps Manual Release Button - Metric

TUBE MM	WHITE PART NO.	BLACK PART NO.	GREEN PART NO.	RED PART NO.	BLUE PART NO.	YELLOW PART NO.
4	3110 04 00	3330 04 01	3110 04 02	3110 04 03	3110 04 04	3110 04 05
6	3110 06 00	3330 06 01	3110 06 02	3110 06 03	3110 06 04	3110 06 05
8	3110 08 00	-	3110 08 02	3110 08 03	3110 08 04	3110 08 05
10	3110 10 00	-	3110 10 02	3110 10 03	3110 10 04	3110 10 05
12	3110 12 00	-	3110 12 02	3110 12 03	3110 12 04	3110 12 05
14	3110 14 00	-	3110 14 02	3110 14 03	3110 14 04	3110 14 05

In all sizes of the LF3000 fittings, except 3/16, the push button is an integral part of the design which makes it non-removable, and comes standard in black. For identification of the circuits, colored caps (p/n 3110) fit over the black push button.

On the 3/16 sizes, the buttons are removable and can be replaced with a button of another color (p/n 3330).

Six colors are available which allow color coding of the fitting, in association with tubes of the same color.

WARNING These products can expose you to chemicals including NICKEL, which is known to the state of California to cause cancer. For more information go to www.P65Warnings.ca.gov.



Prestolok PLM Metal Push-to-Connect Fittings

To meet your technical and environment requirements, Parker’s Prestolok PLM fittings offers the robustness, reliability and resistance to industrial fluids for the most demanding environments.

Product Features:

- High phosphorous, FDA-compliant, chemical resistant, nickel-plated collet and body
- FKM seal
- Chemical, corrosion, and abrasion resistance
- NPT, BSPT, BSPP, and metric threads
- Silicone Free

Markets:

- Industrial
- Chemical
- Life Science
- Automation
- Food Processing

Applications:

- Food Fluids
- Harsh Detergents
- Cleaning In Cold/ Hot Water
- Steam
- Oils

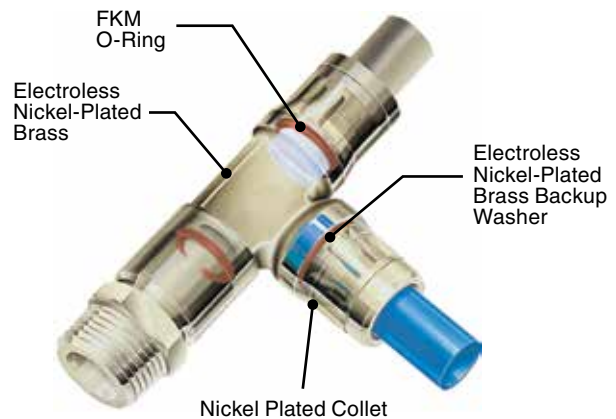

Specifications:

Pressure Range 7 to 290 PSI (0.4 to 19.9 bar)

Temperature Range -4° to +302° F (-20° to +150° C)

Note: Maximum pressure and temperature range depend on the type of tubing used.

Compatible Tubing:

- Polyethylene
- Polyurethane 95 Durometer Shore A
- FEP
- Nylon



































Assembly Instructions

1. Cut tubing squarely – maximum of 15° angle allowable.
2. Check that port or mating part is clean and free of debris.
3. Mark tubing to appropriate tube insertion length. (see Tube Insertion Chart on page N22)
4. Insert tubing until it bottoms
5. Pull on tubing to verify it is fully inserted
6. To disassemble, simply press release button, hold against body and pull tubing out of fitting.



WARNING These products can expose you to chemicals including LEAD which is known to the state of California to cause cancer and birth defects or other reproductive harm. For more information go to www.P65Warnings.ca.gov.



Tube to Male NPT	68PLM Male Connector  p. A38	169PLM Male Elbow  p. A39	171PLM Male Run Tee  p. A40	172PLM Male Branch Tee  p. A41	Tube to Tube	62PLM Union  p. A42	
	165PLM Union Elbow  p. A43	164PLM Union Tee  p. A43	Bulkhead Union  p. A42			Male Standpipes  p. A39	68PLMSP Male Standpipe to BSPT  p. A39
Metric Tube to Male BSPT	68PLM Male Connector  p. A38	169PLM Male Elbow  p. A39	169PLMX Extended Male Elbow  p. A40	171PLM Male Run Tee  p. A41	172PLM Male Branch Tee  p. A41		
	68PLM Male Connector  p. A38	169PLM Male Elbow  p. A40	169PLMX Extended Male Elbow  p. A40	171PLM Male Run Tee  p. A41	172PLM Male Branch Tee  p. A42		
Metric Tube to Female BSPP	66PLM Female Connector  p. A38	Metric Tube to Metric Tube		62PLM Union  p. A42	165PLM Union Elbow  p. A43	164PLM Union Tee  p. A43	
	62PLMBH Bulkhead Union  p. A42	66PLMBH Female Bulkhead  p. A42	165PLMBH Bulkhead Union  p. A43	Metric Plug-in		67PLM Tube Reducer  p. A43	62PLMSP Tube Expander  p. A44
62PLMSP Tube Converter  p. A44	122PLMSP Barbed Connector  p. A44	Metric Banjo Fitting  p. A44		Metric Auxiliary Components		639PLM Plug  p. A44	PLMC Cartridge  p. A44
63PLM Double Male Union  p. A44							

WARNING These products can expose you to chemicals including LEAD which is known to the state of California to cause cancer and birth defects or other reproductive harm. For more information go to www.P65Warnings.ca.gov.

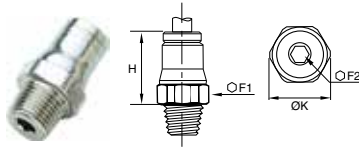

68PLM Male Connector Inch Tube to NPT/UNF

PART NO.	TUBE SIZE IN	NPT/UNF	F1 MM	F2 MM	H IN	K IN
68PLM-4M-0	5/32(4MM)	10-32	10	2.5	.61	.43
68PLM-4M-2	5/32(4MM)	1/8	11	3.0	.59	.47
68PLM-4M-4	5/32(4MM)	1/4	14	3.0	.59	.59
68PLM-4-0	1/4	10-32	13	2.5	.75	.55
68PLM-4-2	1/4	1/8	13	4.0	.67	.55
68PLM-4-4	1/4	1/4	14	4.0	.67	.59
68PLM-4-6	1/4	3/8	18	5.0	.67	.77
68PLM-6-2	3/8	1/8	18	4.0	.97	.77
68PLM-6-4	3/8	1/4	18	7.0	.95	.77
68PLM-6-6	3/8	3/8	18	8.0	.91	.77
68PLM-6-8	3/8	1/2	22	8.0	.95	.94
68PLM-8-6	1/2	3/8	22	9.0	.95	.94
68PLM-8-8	1/2	1/2	22	10.0	.95	.94

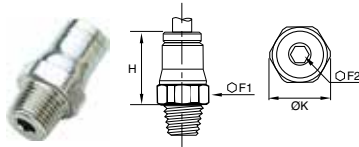

68PLM Male Connector Metric Tube to BSPT

PART NO.	TUBE SIZE MM	BSPT	F1 MM	F2 MM	H MM	K MM
68PLM-4M-2R	4	1/8	10	3	15.00	11.00
68PLM-4M-4R	4	1/4	14	3	15.00	15.00
68PLM-6M-2R	6	1/8	13	4	17.00	14.00
68PLM-6M-4R	6	1/4	14	4	17.00	15.00
68PLM-8M-2R	8	1/8	15	5	19.00	16.00
68PLM-8M-4R	8	1/4	15	6	18.00	16.00
68PLM-8M-6R	8	3/8	17	6	18.50	18.50
68PLM-10M-4R	10	1/4	18	7	23.00	19.50
68PLM-10M-6R	10	3/8	18	8	22.50	19.50
68PLM-10M-8R	10	1/2	22	8	22.50	24.00
68PLM-12M-4R	12	1/4	20	7	25.50	22.00
68PLM-12M-6R	12	3/8	20	9	24.00	22.00
68PLM-12M-8R	12	1/2	22	10	23.00	24.00
68PLM-14M-6R	14	3/8	22	9	27.00	24.00
68PLM-14M-8R	14	1/2	24	11	26.00	26.00

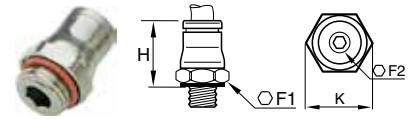

68PLM Male Connector Tube to UNF, BSPP or Metric

PART NO.	TUBE SIZE MM	BSPP/METRIC	F1 MM	F2 MM	H MM	K MM
68PLM-4M-M5	4	M5X0.8	10	2.50	15.50	11.00
68PLM-4M-M6	4	M6X1	13	3.00	14.50	14.00
68PLM-4M-2G	4	1/8	10	3.00	16.00	11.00
68PLM-4M-4G	4	1/4	16	3.00	14.50	17.50
68PLM-4M-M8	4	M8X1	11	3.00	14.50	12.00
68PLM-6M-M5	6	M5X0.8	13	2.50	19.00	14.00
68PLM-6M-2G	6	1/8	13	4.00	17.50	14.00
68PLM-6M-M10	6	M10X1	13	4.00	17.50	14.00
68PLM-6M-4G	6	1/4	16	4.00	17.00	17.50
68PLM-8M-2G	8	1/8	15	5.00	20.00	16.00
68PLM-8M-4G	8	1/4	16	6.00	18.00	17.50
68PLM-8M-6G	8	3/8	20	6.00	19.00	22.00
68PLM-10M-4G	10	1/4	18	7.00	25.00	19.50
68PLM-10M-6G	10	3/8	20	8.00	22.50	22.00
68PLM-10M-8G	10	1/2	24	8.00	22.50	26.00
68PLM-12M-4G	12	1/4	20	7.00	27.00	22.00
68PLM-12M-6G	12	3/8	20	9.00	26.00	22.00
68PLM-12M-8G	12	1/2	24	10.00	23.50	26.00
68PLM-14M-6G	14	3/8	22	9.00	28.00	24.00
68PLM-14M-8G	14	1/2	24	11.00	26.50	26.00

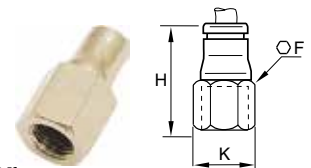

66PLM Female Connector Metric Tube to BSPP or M5

PART NO.	TUBE SIZE MM	BSPP/M5	F MM	H MM	K MM
66PLM-4M-M5	4	M5X0.8	10	22.00	11.00
66PLM-4M-2G	4	1/8	14	25.00	15.00
66PLM-4M-4G	4	1/4	17	29.00	18.50
66PLM-6M-2G	6	1/8	14	27.50	15.00
66PLM-6M-4G	6	1/4	17	31.50	18.50
66PLM-8M-2G	8	1/8	15	28.50	16.00
66PLM-8M-4G	8	1/4	17	32.50	18.50
66PLM-10M-6G	10	3/8	22	38.00	24.00
66PLM-12M-6G	12	3/8	22	39.00	24.00
66PLM-12M-8G	12	1/2	24	43.50	26.00

WARNING These products can expose you to chemicals including LEAD which is known to the state of California to cause cancer and birth defects or other reproductive harm. For more information go to www.P65Warnings.ca.gov.

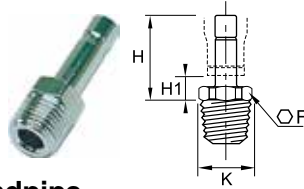

68PLMSP Male Stud Standpipe Metric Tube to BSPT

PART NO.	TUBE SIZE MM	BSPT	F MM	H MM	H1 MM	K MM
68PLMSP-4M-2R	4	1/8	10	21.00	7.00	11.00
68PLMSP-6M-2R	6	1/8	10	23.50	6.50	11.00
68PLMSP-6M-4R	6	1/4	10	23.50	6.50	15.00
68PLMSP-8M-2R	8	1/8	10	24.00	6.50	11.00
68PLMSP-8M-4R	8	1/4	14	24.00	6.50	15.00
68PLMSP-10M-4R	10	1/4	14	22.00	6.50	15.00
68PLMSP-10M-6R	10	3/8	17	30.00	7.50	18.50
68PLMSP-12M-6R	12	3/8	17	31.00	7.50	18.50
68PLMSP-12M-8R	12	1/2	22	38.00	7.50	24.00
68PLMSP-14M-8R	14	1/2	22	33.00	8.00	24.00

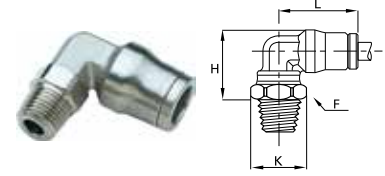

169PLM Male Elbow Inch Tube to NPT, UNF

PART NO.	TUBE SIZE IN	NPT/UNF	F MM	H IN	K IN	L IN
169PLM-4M-0	5/32(4MM)	10-32	10	0.71	0.43	.71
169PLM-4M-2	5/32(4MM)	1/8	11	.59	.47	.71
169PLM-4M-4	5/32(4MM)	1/4	14	.67	.60	.71
169PLM-4-2	1/4	1/8	11	.69	.47	.87
169PLM-4-4	1/4	1/4	14	.75	.60	.87
169PLM-4-6	1/4	3/8	18	.75	.77	.87
169PLM-6-4	3/8	1/4	15	.93	.63	1.14
169PLM-6-6	3/8	3/8	18	1.02	.77	1.14
169PLM-6-8	3/8	1/2	22	1.06	.94	1.14
169PLM-8-6	1/2	3/8	18	1.14	.77	1.22
169PLM-8-8	1/2	1/2	22	1.14	.94	1.22

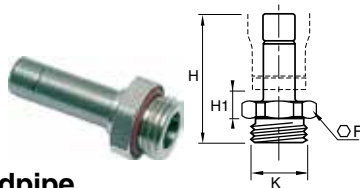

68PLMSP Male Standpipe Metric Tube to BSPP or M5

PART NO.	TUBE SIZE MM	BSPP/M5	F MM	H MM	H1 MM	K MM
68PLMSP-4M-M5	4	M5X0.8	13	25.50	7.00	14.00
68PLMSP-4M-2G	4	1/8	16	26.50	7.00	17.50
68PLMSP-4M-4G	4	1/4	8	25.00	7.50	8.70
68PLMSP-6M-2G	6	1/8	13	28.00	6.50	14.00
68PLMSP-6M-4G	6	1/4	16	29.00	6.50	17.50
68PLMSP-8M-2G	8	1/8	13	28.50	6.50	14.00
68PLMSP-8M-4G	8	1/4	16	29.50	6.50	17.50
68PLMSP-8M-6G	8	3/8	20	30.50	7.50	22.00
68PLMSP-10M-4G	10	1/4	16	34.50	6.50	17.50
68PLMSP-10M-6G	10	3/8	20	35.50	7.50	22.00
68PLMSP-10M-8G	10	1/2	24	37.00	7.50	26.00
68PLMSP-12M-6G	12	3/8	20	36.50	7.50	22.00
68PLMSP-12M-8G	12	1/2	24	38.00	7.50	26.00
68PLMSP-14M-8G	14	1/2	24	40.00	8.00	26.00

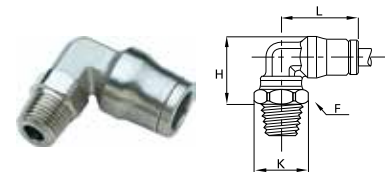

169PLM Male Elbow Metric Tube to BSPT

PART NO.	TUBE SIZE MM	BSPT	F MM	H MM	K MM	L MM
169PLM-4M-2R	4	1/8	11	15.00	12.00	18.00
169PLM-4M-4R	4	1/4	14	17.00	15.00	18.00
169PLM-6M-2R	6	1/8	11	17.50	12.00	21.50
169PLM-6M-4R	6	1/4	14	19.00	15.00	21.50
169PLM-8M-2R	8	1/8	11	19.50	12.00	23.50
169PLM-8M-4R	8	1/4	14	21.00	15.00	23.50
169PLM-8M-6R	8	3/8	17	21.00	18.50	23.50
169PLM-10M-4R	10	1/4	15	23.50	16.00	29.00
169PLM-10M-6R	10	3/8	17	25.50	18.50	29.00
169PLM-12M-4R	12	1/4	15	26.00	16.00	31.00
169PLM-12M-6R	12	3/8	17	28.50	18.50	31.00
169PLM-12M-8R	12	1/2	21	28.50	23.00	31.00
169PLM-14M-6R	14	3/8	19	29.00	21.00	34.00
169PLM-14M-8R	14	1/2	24	30.00	26.00	34.00

WARNING These products can expose you to chemicals including LEAD which is known to the state of California to cause cancer and birth defects or other reproductive harm. For more information go to www.P65Warnings.ca.gov.

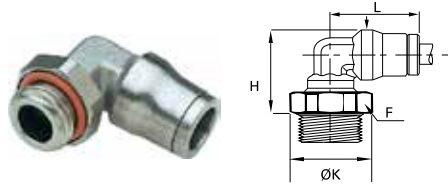

169PLM Male Elbow Tube to BSPP, Metric

PART NO.	TUBE SIZE MM	BSPP/METRIC	F MM	H MM	K MM	L MM
169PLM-4M-M5	4	M5X0.8	10	18.00	11.00	18.00
169PLM-4M-2G	4	1/8	13	17.00	14.00	18.00
169PLM-4M-M6	4	M6X1	10	18.00	11.00	18.00
169PLM-4M-4G	4	1/4	16	17.50	17.50	18.00
169PLM-4M-M8	4	M8X1	11	18.00	12.00	18.00
169PLM-6M-2G	6	1/8	13	19.00	14.00	21.50
169PLM-6M-M10	6	M10X1	13	19.00	14.00	21.50
169PLM-6M-4G	6	1/4	16	19.50	17.50	21.50
169PLM-8M-2G	8	1/8	13	20.50	14.00	23.50
169PLM-8M-4G	8	1/4	16	21.50	17.50	23.50
169PLM-8M-6G	8	3/8	20	21.50	22.00	23.50
169PLM-10M-4G	10	1/4	16	27.00	17.50	29.00
169PLM-10M-6G	10	3/8	20	25.50	22.00	29.00
169PLM-12M-4G	12	1/4	16	29.50	17.50	31.00
169PLM-12M-6G	12	3/8	20	28.50	22.00	31.00
169PLM-12M-8G	12	1/2	24	28.50	26.00	31.00
169PLM-14M-6G	14	3/8	20	29.00	22.00	34.00
169PLM-14M-8G	14	1/2	24	29.50	26.00	34.00

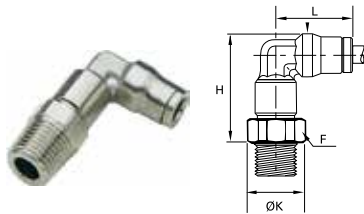

169PLMX Extended Male Elbow Metric Tube to BSPT

PART NO.	TUBE SIZE MM	BSPT	F MM	H MM	K MM	L MM
169PLMX-4M-2R	4	1/8	10	24.50	11.00	18.00
169PLMX-6M-2R	6	1/8	13	29.50	14.00	21.50
169PLMX-6M-4R	6	1/4	14	30.50	15.00	21.50
169PLMX-8M-2R	8	1/8	14	32.50	15.00	23.50
169PLMX-8M-4R	8	1/4	14	34.00	15.00	23.50
169PLMX-10M-4R	10	1/4	18	39.00	19.50	29.00

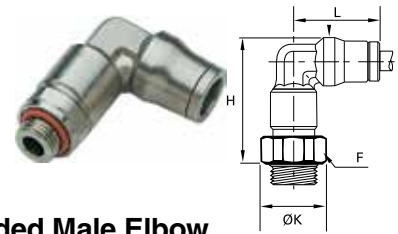

169PLMX Extended Male Elbow Metric Tube to BSPP or M5

PART NO.	TUBE SIZE MM	BSPP/M5	F MM	H MM	K MM	L MM
169PLMX-4M-M5	4	M5X0.8	10	27.50	11.00	18.00
169PLMX-4M-2G	4	1/8	13	25.50	14.00	18.00
169PLMX-6M-2G	6	1/8	13	31.00	14.00	18.00
169PLMX-6M-4G	6	1/4	16	30.50	17.50	21.50
169PLMX-8M-2G	8	1/8	14	33.50	15.00	23.50
169PLMX-8M-4G	8	1/4	16	34.00	17.50	23.50
169PLMX-10M-4G	10	1/4	18	42.00	19.50	29.00
169PLMX-10M-6G	10	3/8	20	41.00	22.00	29.00
169PLMX-12M-4G	12	1/4	20	47.00	22.00	31.00
169PLMX-12M-6G	12	3/8	20	46.00	22.00	31.00
169PLMX-14M-8G	14	1/2	24	49.00	26.00	34.00

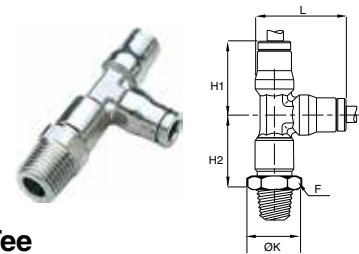

171PLM Male Run Tee Inch Tube to Tube to NPT, UNF

PART NO.	TUBE SIZE IN	NPT/UNF	F MM	H1 IN	H2 IN	K IN	L IN
171PLM-4M-2	5/32(4MM)	1/8	11	.71	.77	.47	.91

WARNING These products can expose you to chemicals including LEAD which is known to the state of California to cause cancer and birth defects or other reproductive harm. For more information go to www.P65Warnings.ca.gov.

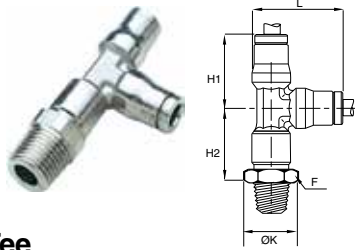

**171PLM Male Run Tee
Metric Tube To Tube to BSPT**

PART NO.	TUBE SIZE MM	BSPT	F MM	H1 MM	H2 MM	K MM	L MM
171PLM-4M-2R	4	1/8	10	18.00	19.50	11.00	23.00
171PLM-6M-2R	6	1/8	13	21.50	23.50	14.00	28.00
171PLM-6M-4R	6	1/4	14	21.50	24.50	15.00	28.00
171PLM-8M-2R	8	1/8	14	23.50	25.00	15.00	31.00
171PLM-8M-4R	8	1/4	14	23.50	26.50	15.00	31.00
171PLM-10M-4R	10	1/4	18	29.00	30.50	19.50	37.50
171PLM-10M-6R	10	3/8	18	29.00	32.50	19.50	37.50
171PLM-12M-6R	12	3/8	21	31.00	36.50	23.00	40.50
171PLM-14M-8R	14	1/2	22	34.00	40.00	24.00	45.00

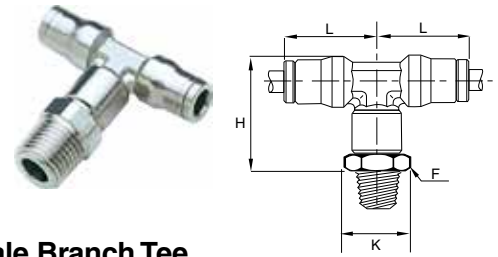

**172PLM Male Branch Tee
Inch Tube to NPT to tube**

PART NO.	TUBE SIZE IN	NPT/UNF	F MM	H IN	K IN	L IN
172PLM-4M-0	5/32(4MM)	10-32	10.00	1.00	.47	.71

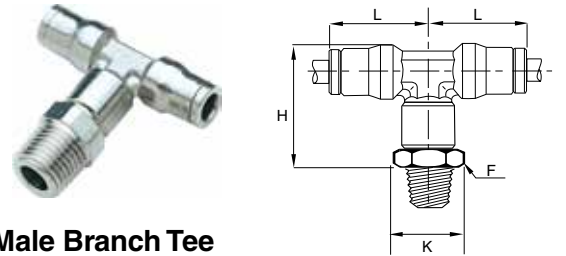

**172PLM Male Branch Tee
Metric Tube to BSPT**

PART NO.	TUBE SIZE MM	BSPT	F MM	H MM	K MM	L MM
172PLM-4M-2R	4	1/8	10	24.50	11.00	18.00
172PLM-6M-2R	6	1/8	13	29.50	14.00	21.50
172PLM-6M-4R	6	1/4	14	30.50	15.00	21.50
172PLM-8M-2R	8	1/8	14	32.50	15.00	23.50
172PLM-8M-4R	8	1/4	14	34.00	15.00	23.50
172PLM-10M-4R	10	1/4	18	39.00	19.50	29.00
172PLM-10M-6R	10	3/8	18	41.00	19.50	29.00
172PLM-12M-6R	12	3/8	21	46.50	23.00	31.00
172PLM-14M-8R	14	1/2	22	50.50	24.00	34.00

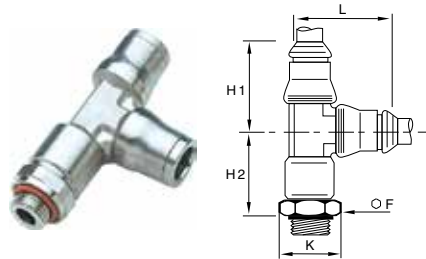

**171PLM Male Run Tee
Tube To Tube to BSPP or M5**

PART NO.	TUBE SIZE MM	BSPP/M5	F MM	H1 MM	H2 MM	K MM	L MM
171PLM-4M-M5	4	M5X0.8	10	18.00	22.50	11.00	23.00
171PLM-6M-2G	6	1/8	13	21.50	25.00	14.00	28.00
171PLM-6M-4G	6	1/4	16	21.50	24.50	17.50	28.00
171PLM-8M-2G	8	1/8	14	23.50	26.50	15.00	31.00
171PLM-8M-4G	8	1/4	16	23.50	26.50	17.50	31.00
171PLM-10M-4G	10	1/4	18	29.00	33.00	19.50	37.50
171PLM-12M-6G	12	3/8	21	31.00	36.50	23.00	40.50
171PLM-14M-8G	14	1/2	24	34.00	38.50	26.00	45.00

WARNING These products can expose you to chemicals including LEAD which is known to the state of California to cause cancer and birth defects or other reproductive harm. For more information go to www.P65Warnings.ca.gov.

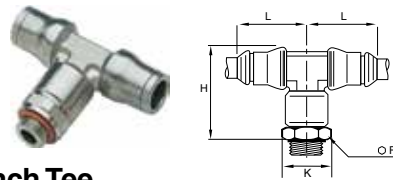

172PLM Male Branch Tee Tube to BSPP or M5

PART NO.	TUBE SIZE MM	BSPP/M5	F MM	H MM	K MM	L MM
172PLM-4M-M5	4	M5X0.8	10	27.50	11.00	18.00
172PLM-4M-2G	4	1/8	13	25.50	14.00	18.00
172PLM-6M-2G	6	1/8	13	31.00	14.00	21.50
172PLM-6M-4G	6	1/4	16	30.50	17.50	21.50
172PLM-8M-2G	8	1/8	14	33.50	15.00	23.50
172PLM-8M-4G	8	1/4	16	34.00	17.50	23.50
172PLM-10M-4G	10	1/4	18	42.00	19.50	29.00
172PLM-12M-6G	12	3/8	21	46.00	23.00	31.00
172PLM-14M-8G	14	1/2	24	49.00	26.00	34.00

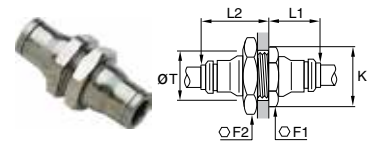

62PLMBH Bulkhead Connector Inch Tube to Tube

PART NO.	TUBE SIZE IN	F1 MM	F2 MM	K IN	L1 IN	L2 IN	T IN
62PLMBH-4	1/4	16	17	.69	.67	.89	.59
62PLMBH-6	3/8	22	27	.95	.87	1.10	.85
62PLMBH-8	1/2	24	24	1.16	.89	1.14	1.04

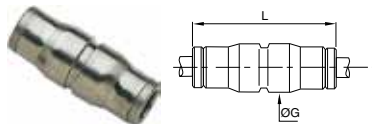

62PLM Straight Union Inch Tube to Tube

PART NO.	TUBE SIZE IN	G IN	L IN
62PLM-4	1/4	.49	1.44
62PLM-6	3/8	.67	1.87
62PLM-8	1/2	.79	1.89

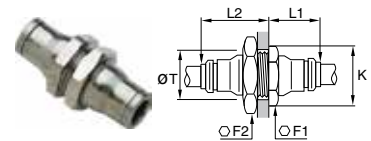

62PLMBH Bulkhead Connector Metric Tube to Tube

PART NO.	TUBE SIZE MM	F1 MM	F2 MM	K MM	L1 MM	L2 MM	T MM
62PLMBH-4M	4MM(5/32)	13	14	14.00	14.00	20.00	12.50
62PLMBH-6M	6	16	17	17.50	17.00	22.00	15.00
62PLMBH-8M	8MM(5/16)	18	19	19.50	18.50	23.50	17.00
62PLMBH-10M	10	22	27	24.00	21.50	26.50	21.00
62PLMBH-12M	12	24	24	26.00	23.00	27.00	23.00
62PLMBH-14M	14	27	27	29.50	25.50	29.50	25.00

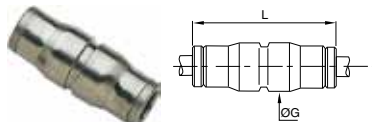

62PLM Straight Union Metric Tube to Tube

PART NO.	TUBE SIZE MM	G MM	L MM
62PLM-4M	4MM(5/32)	10.00	30.50
62PLM-6M	6	12.00	36.50
62PLM-8M	8MM(5/16)	15.00	37.50
62PLM-10M	10	17.50	47.50
62PLM-12M	12	19.50	50.00
62PLM-14M	14	21.50	52.50

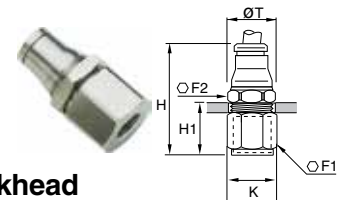

66PLMBH Female Bulkhead Connector Metric Tube to BSPP

PART NO.	TUBE SIZE MM	BSPP	F1 MM	F2 MM	H MM	H1 MM	K MM	T MM
66PLMBH-4M-2G	4	1/8	14	14	30.50	11.00	15.00	13
66PLMBH-6M-2G	6	1/8	17	17	32.50	11.00	18.50	15
66PLMBH-6M-4G	6	1/4	17	17	37.00	15.00	18.50	15
66PLMBH-8M-2G	8	1/8	19	19	34.00	10.50	21.00	17
66PLMBH-8M-4G	8	1/4	19	19	38.00	14.50	21.00	17
66PLMBH-10M-6G	10	3/8	22	27	42.50	16.00	24.00	21
66PLMBH-12M-6G	12	3/8	24	24	43.00	16.00	26.00	23
66PLMBH-12M-8G	12	1/2	27	24	48.50	21.50	29.50	23

WARNING These products can expose you to chemicals including LEAD which is known to the state of California to cause cancer and birth defects or other reproductive harm. For more information go to www.P65Warnings.ca.gov.

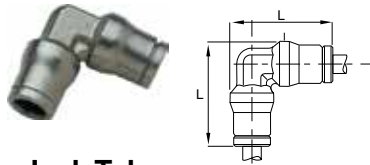

165PLM Union Elbow Inch Tube

PART NO.	TUBE SIZE IN	L IN
165PLM-4	1/4	1.12
165PLM-6	3/8	1.48
165PLM-8	1/2	1.61

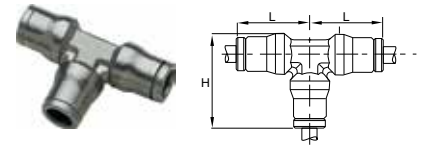

164PLM Union Tee Inch Tube

PART NO.	TUBE SIZE IN	H IN	L IN
164PLM-4	1/4	1.12	.87
164PLM-6	3/8	1.48	1.14
164PLM-8	1/2	1.61	1.22

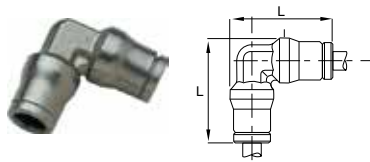

165PLM Union Elbow Metric Tube

PART NO.	TUBE SIZE MM	L MM
165PLM-4M	4MM(5/32)	23.00
165PLM-6M	6	28.00
165PLM-8M	8MM(5/16)	31.00
165PLM-10M	10	37.50
165PLM-12M	12	40.50
165PLM-14M	14	45.00

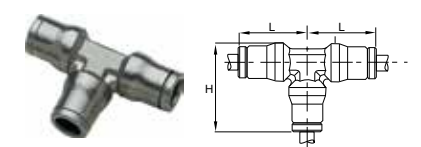

164PLM Union Tee Metric Tube

PART NO.	TUBE SIZE MM	H MM	L MM
164PLM-4M	4MM(5/32)	23.00	18.00
164PLM-6M	6	28.00	21.50
164PLM-8M	8MM(5/16)	31.00	23.50
164PLM-10M	10	37.50	29.00
164PLM-12M	12	40.50	31.00
164PLM-14M	14	45.00	34.00

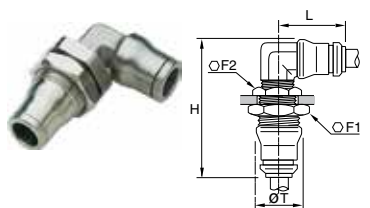

165PLMBH Bulkhead Elbow Metric Tube

PART NO.	TUBE SIZE MM	F1 MM	F2 MM	H MM	L MM	T MM
165PLMBH-4M	4	13	14	35.00	18.00	12.50
165PLMBH-6M	6	16	17	40.50	21.50	15.00
165PLMBH-8M	8	18	19	44.00	23.50	17.00
165PLMBH-10M	10	22	27	51.00	29.00	21.00
165PLMBH-12M	12	24	24	55.00	31.00	23.00
165PLMBH-14M	14	27	27	59.00	34.00	25.00

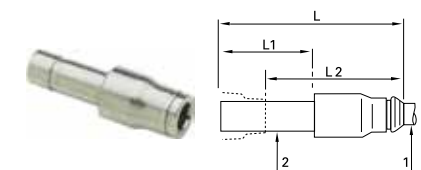

67PLM Plug-In Reducer Metric

PART NO.	TUBE 1 SIZE MM	TUBE 2 SIZE MM	L MM	L1 MM	L2 MM
67PLM-4M-6M	4	6	34.50	19.00	17.50
67PLM-4M-8M	4	8	35.50	20.00	18.00
67PLM-6M-8M	6	8	37.00	20.00	19.50
67PLM-6M-10M	6	10	43.50	25.00	21.00
67PLM-8M-10M	8	10	44.00	25.00	21.50
67PLM-8M-12M	8	12	45.00	26.00	21.50
67PLM-10M-12M	10	12	50.00	26.00	26.50
67PLM-12M-14M	12	14	53.00	28.00	28.50

WARNING These products can expose you to chemicals including LEAD which is known to the state of California to cause cancer and birth defects or other reproductive harm. For more information go to www.P65Warnings.ca.gov.

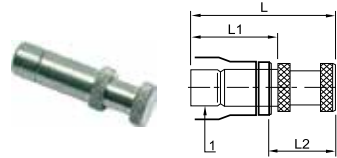

639PLM Plug Metric

PART NO.	TUBE 1 SIZE MM	L MM	L1 MM	L2 MM
639PLM-4M	4	25.50	17.00	11.50
639PLM-6M	6	30.50	19.50	13.50
639PLM-8M	8	33.00	20.00	16.00
639PLM-10M	10	40.00	25.00	18.00
639PLM-12M	12	43.00	26.00	20.00
639PLM-14M	14	47.00	28.00	22.50

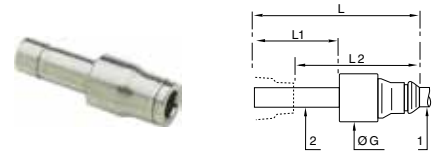

62PLMSP Plug-In Expander Metric

PART NO.	TUBE 1 SIZE MM	TUBE 2 SIZE MM	G MM	L MM	L1 MM	L2 MM
62PLMSP-4-6	6	4	17	42	22	28

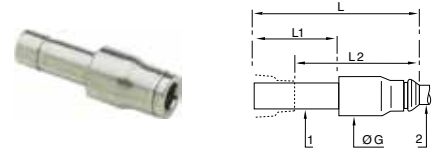

62PLMSP Plug-In Metric/Inch Adapter

PART NO.	TUBE 1 SIZE MM	TUBE 2 SIZE IN	G MM	L MM	L1 MM	L2 MM
62PLMSP-6M-4	6	1/4	12.50	38.00	19.00	20.50
62PLMSP-10M-6	10	3/8	17.00	49.50	25.00	27.00
62PLMSP-12M-8	12	1/2	20.00	51.00	26.00	27.50

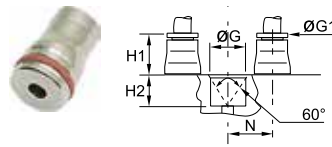

PLMC Cartridge

PART NO.	TUBE SIZE MM	G +.1 - 0	H1 MM	H2 MM	N MM
PLMC-4M	4	10.00	9.00	8.50	11.00
PLMC-6M	6	12.00	11.00	8.50	13.50
PLMC-8M	8	15.00	12.50	8.50	16.00
PLMC-10M	10	17.50	14.50	10.50	20.00
PLMC-12M	12	19.50	15.00	10.50	22.50
PLMC-14M	14	21.50	16.50	12.00	25.00

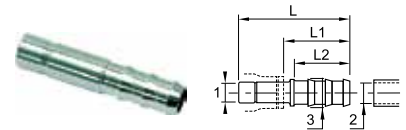

122PLMSP Plug-In Barbed Connector Metric

PART NO.	TUBE 1 SIZE MM	TUBE 2 SIZE MM	TUBE 3 SIZE MM	L MM	L1 MM	L2 MM
122PLMSP-4M-3M	4	3.20	5.00	40.50	27.00	22.50
122PLMSP-4M-5M	4	5.00	7.00	40.50	27.00	22.50
122PLMSP-6M-5M	6	5.00	7.00	43.00	27.00	22.50
122PLMSP-8M-6M	8	6.30	8.30	42.00	25.00	22.50
122PLMSP-8M-8M	8	8.00	10.00	44.00	27.00	22.50
122PLMSP-10M-6M	10	6.30	8.30	47.50	25.50	22.50
122PLMSP-10M-8M	10	8.00	10.00	47.50	25.50	22.50
122PLMSP-12M-8M	12	8.00	10.00	48.50	25.50	22.50
122PLMSP-12M10M	12	10.00	12.00	48.50	25.50	22.50
122PLMSP-12M12M	12	12.50	14.50	57.00	34.00	29.50
122PLMSP-14M12M	14	12.50	14.50	57.50	33.00	29.50
122PLMSP-14M14M	14	14.00	16.00	59.50	35.00	29.50

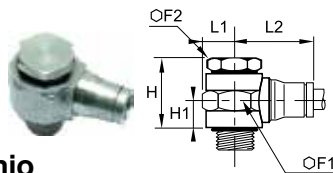

169PLMBJ Single Banjo Metric Tube to BSPP or M5

PART NO.	TUBE SIZE MM	BSPP/M5	F1 MM	F2 MM	H MM	H1 MM	L1 MM	L2 MM
169PLMBJ-4M-M5	4	M5X0.8	10	8	14.50	6.50	6.00	18.50
169PLMBJ-4M-2G	4	G1/8	17	14	23.00	9.50	10.00	20.50
169PLMBJ-6M-M5	6	M5X0.8	10	8	15.00	7.00	6.00	22.50
169PLMBJ-6M-2G	6	G1/8	17	14	23.00	9.50	10.00	23.50
169PLMBJ-6M-4G	6	G1/4	22	17	22.00	9.00	13.00	25.50
169PLMBJ-8M-2G	8	G1/8	17	14	23.00	9.50	10.00	26.00
169PLMBJ-8M-4G	8	G1/4	22	17	22.00	9.00	13.00	27.50
169PLMBJ-10M-6G	10	G3/8	22	22	33.00	14.00	13.00	32.00



63PLM Double Male Union Metric

PART NO.	TUBE SIZE MM	L MM	L1 MM
63PLM-4M	4	31.00	14.00
63PLM-6M	6	36.50	17.00
63PLM-8M	8	37.50	17.50
63PLM-10M	10	47.50	22.50
63PLM-12M	12	49.50	23.50
63PLM-14M	14	53.00	25.00

WARNING These products can expose you to chemicals including LEAD which is known to the state of California to cause cancer and birth defects or other reproductive harm. For more information go to www.P65Warnings.ca.gov.





Prestolok PLS Stainless Steel Push-to-Connect Fittings

Parker's Prestolok PLS fittings are ideal for conveying corrosive fluids in aggressive environments. Prestolok PLS fittings provide corrosion resistance and a hygienic external design.

Product Features:

- Stainless steel 316L collet
- Stainless steel 316L body
- FKM seal
- Stainless steel 316L backup washer
- Chemical, corrosion, and abrasion resistance
- Hygienic design reduces retention zones for
- Easy cleaning
- NPT, BSPT, BSPP, and metric threads
- Silicone Free

Markets:

- Petrochemical
- Life Science
- Pulp and Paper
- Food Processing
- Wash Down

Applications:

- Food Fluids
- Chemicals
- Cleaning Agents

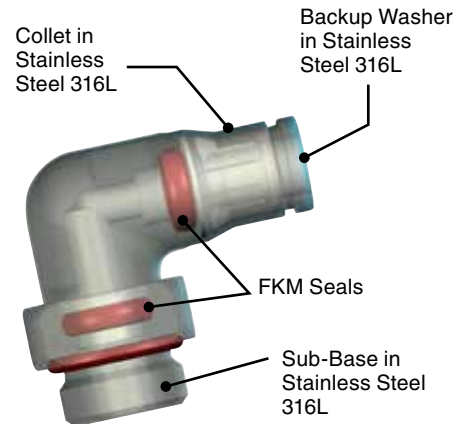

Specifications:

Pressure Range	Up to 435 PSI (29.9 bar) depending on type of tubing
Temperature Range	-4° to +302° F (-20° to +150° C)
Vacuum Capability	28" Hg

Assembly Instructions































1. Cut tubing squarely – maximum of 15° angle allowable.
2. Check that port or mating part is clean and free of debris.
3. Mark tubing to appropriate tube insertion length. (see Tube Insertion Chart on page N22)
4. Insert tubing until it bottoms
5. Pull on tubing to verify it is fully inserted
6. To disassemble, simply press release button, hold against body and pull tubing out of fitting.

Compatible Tubing:

- Semi-rigid nylon
- Polyethylene
- Polyurethane 95 Durometer Shore A
- Stainless Steel (grooved)
- Copper (grooved)

WARNING These products can expose you to chemicals including NICKEL, which is known to the state of California to cause cancer. For more information go to www.P65Warnings.ca.gov.



Tube to Male NPT	68PLS Male Connector  p. A48	169PLS Male Elbow  p. A50	171PLS Male Run Tee  p. A51	172PLS Male Branch Tee  p. A52	Tube to Tube	62PLS Union  p. A52
	165PLS Union Elbow  p. A52	164PLS Union Tee  p. A53	Bulkhead Union	62PLSBH Bulkhead Union  p. A52		Standpipe to NPT
Metric Tube to Male BSPT	68PLS Male Connector  p. A48	169PLS Male Elbow  p. A50		169PLSX Extended Male Elbow  p. A51		
	Metric Tube to Male BSPP	68PLS Male Connector  p. A48	169PLS Male Elbow  p. A50	169PLSX Extended Male Elbow  p. A51	171PLS Male Run Tee  p. A51	172PLS Male Branch Tee  p. A52
Metric Tube to Male NPT		68PLS Male Connector  p. A48	169PLS Male Elbow  p. A50	169PLSX Extended Male Elbow  p. A51	171PLS Male Run Tee  p. A52	172PLS Male Branch Tee  p. A53
	Metric Tube to Metric Tube	62PLS Union  p. A52	165PLS Union Elbow  p. A53	164PLS Union Tee  p. A53	Metric Bulkhead Union	62PLSBH Bulkhead Union  p. A52
Metric Standpipes		68PLSSP Male Standpipe to NPT  p. A49	68PLSSP Male Standpipe to BSPT  p. A49	68PLSSP Male Standpipe to BSPP  p. A49		Metric Plugin
	Metric Auxiliary Components	639PLS Plug  p. A53	PLSC Cartridge  p. A53			

WARNING These products can expose you to chemicals including NICKEL, which is known to the state of California to cause cancer. For more information go to www.P65Warnings.ca.gov.

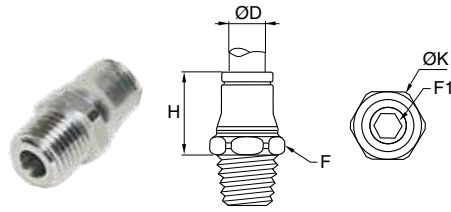

68PLS Male Connector - Inch Tube to NPT, UNF

PART NO.	TUBE SIZE IN	NPT / UNF	F MM	F1 MM	H IN	K IN
68PLS-4M-0	5/32(4MM)	10-32	10	2.5	.59	.43
68PLS-3-2	3/16	1/8	10	3	.61	.43
68PLS-4-2	1/4	1/8	13	4	.75	.55
68PLS-4-4	1/4	1/4	14	4	.69	.59
68PLS-6-4	3/8	1/4	19	6	.98	.83
68PLS-6-6	3/8	3/8	19	7	.94	.83
68PLS-8-4	1/2	1/4	22	7	1.02	.94
68PLS-8-6	1/2	3/8	22	8	.98	.94
68PLS-8-8	1/2	1/2	22	10	.98	.94

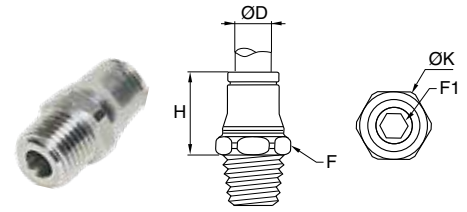

68PLS Male Connector - Metric Tube to BSPT

PART NO.	TUBE SIZE MM	BSPT	F MM	F1 MM	H MM	K MM
68PLS-4M-2R	4	1/8	10	3	14.50	11.00
68PLS-4M-4R	4	1/4	14	3	14.50	15.00
68PLS-6M-2R	6	1/8	13	4	18.00	14.00
68PLS-6M-4R	6	1/4	14	4	16.50	15.00
68PLS-8M-2R	8	1/8	15	5	20.50	16.50
68PLS-8M-4R	8	1/4	15	5	19.00	16.50
68PLS-8M-6R	8	3/8	17	6	19.00	18.50
68PLS-10M-4R	10	1/4	19	6	24.00	21.00
68PLS-10M-6R	10	3/8	19	7	22.50	21.00
68PLS-12M-4R	12	1/4	22	7	25.00	24.00
68PLS-12M-6R	12	3/8	22	8	24.00	24.00
68PLS-12M-8R	12	1/2	22	10	23.00	24.00

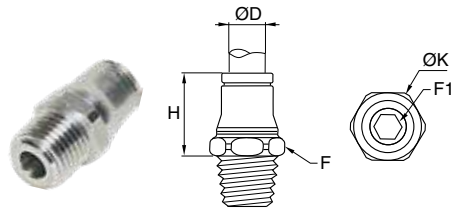

68PLS Male Connector - Metric Tube to NPT

PART NO.	TUBE SIZE MM	NPT	F MM	F1 MM	H MM	K MM
68PLS-4M-2	4MM(5/32)	1/8	11	3	14.50	12.00
68PLS-6M-2	6	1/8	13	4	18.00	14.00
68PLS-6M-4	6	1/4	14	4	16.50	15.00
68PLS-8M-2	8MM(5/16)	1/8	15	5	19.00	16.50
68PLS-8M-4	8MM(5/16)	1/4	15	6	18.00	16.50
68PLS-10M-4	10	1/4	19	6	24.00	21.00
68PLS-10M-6	10	3/8	19	7	22.50	21.00
68PLS-12M-4	12	1/4	22	7	25.00	24.00
68PLS-12M-6	12	3/8	22	8	24.00	24.00
68PLS-12M-8	12	1/2	22	10	23.00	24.00

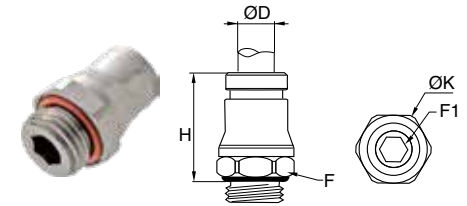

68PLS Male Connector - Metric Tube to BSPP, M5

PART NO.	TUBE SIZE MM	BSPP / M5	F MM	F1 MM	H MM	K MM
68PLS-4M-M5	4	M5X0.8	10	2.5	16.00	11.00
68PLS-4M-2G	4	1/8	13	3	15.00	14.00
68PLS-6M-M5	6	M5X0.8	13	2.5	20.50	14.00
68PLS-6M-2G	6	1/8	13	4	18.00	14.00
68PLS-6M-4G	6	1/4	17	4	18.00	18.50
68PLS-8M-2G	8	1/8	15	5	19.00	16.50
68PLS-8M-4G	8	1/4	17	5	20.50	18.50
68PLS-8M-6G	8	3/8	21	6	20.00	23.00
68PLS-10M-4G	10	1/4	18	7	25.00	19.50
68PLS-10M-6G	10	3/8	21	7	25.00	23.00
68PLS-12M-4G	12	1/4	21	7	27.00	23.00
68PLS-12M-6G	12	3/8	21	9	26.50	23.00

WARNING These products can expose you to chemicals including NICKEL, which is known to the state of California to cause cancer. For more information go to www.P65Warnings.ca.gov.

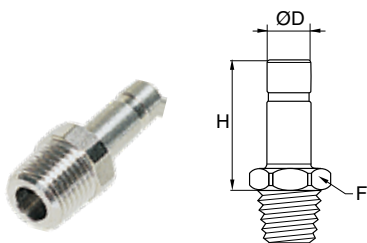

68PLSSP Male Standpipe - Inch Tube to NPT

PART NO.	TUBE SIZE IN	NPT	F IN	H IN
68PLSSP-4-2	1/4	1/8	0.39	1.02
68PLSSP-4-4	1/4	1/4	0.55	1.06
68PLSSP-6-4	3/8	1/4	0.75	1.26
68PLSSP-6-6	3/8	3/8	0.75	1.26
68PLSSP-8-4	1/2	1/4	0.75	1.42
68PLSSP-8-6	1/2	3/8	0.75	1.46
68PLSSP-8-8	1/2	1/2	0.87	1.46

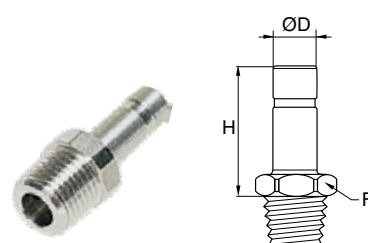

68PLSSP Male Standpipe - Metric Tube to BSPT

PART NO.	TUBE SIZE MM	BSPT	F MM	H MM
68PLSSP-4M-2R	4	1/8	10	21
68PLSSP-6M-2R	6	1/8	10	23
68PLSSP-6M-4R	6	1/4	14	24
68PLSSP-8M-2R	8	1/8	10	24
68PLSSP-8M-4R	8	1/4	14	25
68PLSSP-10M-4R	10	1/4	14	30
68PLSSP-10M-6R	10	3/8	17	30
68PLSSP-12M-4R	12	1/4	14	31
68PLSSP-12M-6R	12	3/8	17	31
68PLSSP-12M-8R	12	1/2	22	32

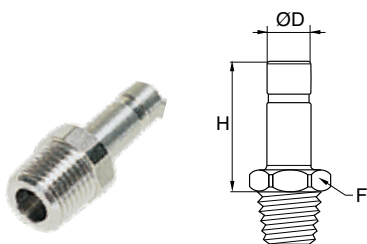

68PLSSP Male Standpipe - Metric Tube to NPT

PART NO.	TUBE SIZE MM	NPT	F MM	H MM
68PLSSP-4M-2	4MM(5/32)	1/8	11	21
68PLSSP-6M-2	6	1/8	11	23
68PLSSP-6M-4	6	1/4	14	24
68PLSSP-8M-2	8MM(5/16)	1/8	14	24
68PLSSP-8M-4	8MM(5/16)	1/4	14	25
68PLSSP-10M-4	10	1/4	14	30
68PLSSP-10M-6	10	3/8	17	30
68PLSSP-12M-4	12	1/4	14	31

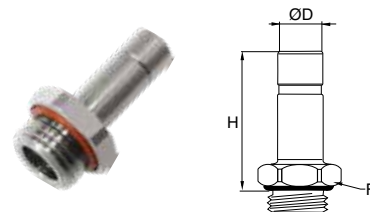

68PLSSP Male Standpipe - Metric Tube to BSPP, M5

PART NO.	TUBE SIZE MM	BSPP / M5	F MM	H MM
68PLSSP-4M-M5	4	M5X0.8	7	23.50
68PLSSP-4M-2G	4	1/8	13	22.00
68PLSSP-6M-2G	6	1/8	13	24.00
68PLSSP-6M-4G	6	1/4	17	24.00
68PLSSP-8M-2G	8	1/8	13	25.00
68PLSSP-8M-4G	8	1/4	17	27.00
68PLSSP-8M-6G	8	3/8	21	27.00
68PLSSP-10M-4G	10	1/4	17	32.00
68PLSSP-10M-6G	10	3/8	21	27.00
68PLSSP-12M-4G	12	1/4	17	33.00
68PLSSP-12M-6G	12	3/8	21	33.00

WARNING These products can expose you to chemicals including NICKEL, which is known to the state of California to cause cancer. For more information go to www.P65Warnings.ca.gov.



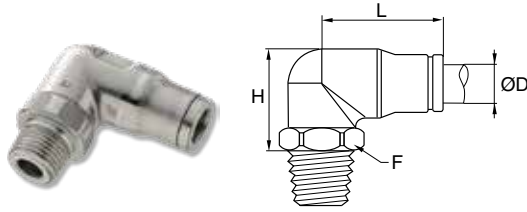

169PLS Male Elbow - Inch Tube to NPT, UNF

PART NO.	TUBE SIZE IN	NPT / UNF	F MM	H IN	L IN
169PLS-4M-0	5/32(4MM)	10-32	10	.98	.77
169PLS-4-2	1/4	1/8	13	.85	.91
169PLS-4-4	1/4	1/4	14	.85	.91
169PLS-6-4	3/8	1/4	17	1.12	1.20
169PLS-6-6	3/8	3/8	19	1.12	1.20
169PLS-8-4	1/2	1/4	22	1.34	1.30
169PLS-8-6	1/2	3/8	22	1.34	1.30
169PLS-8-8	1/2	1/2	22	1.34	1.30

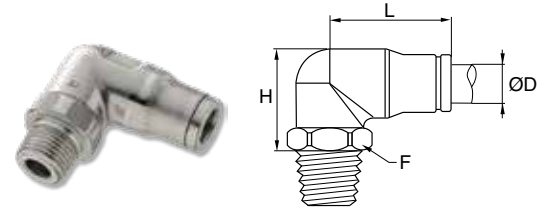

169PLS Male Elbow - Metric Tube to BSPT

PART NO.	TUBE SIZE MM	BSPT	F MM	H MM	L MM
169PLS-4M-2R	4	1/8	13	18.00	19.00
169PLS-4M-4R	4	1/4	14	18.00	19.00
169PLS-6M-2R	6	1/8	13	20.00	24.00
169PLS-6M-4R	6	1/4	14	20.00	23.00
169PLS-8M-2R	8	1/8	13	24.50	32.00
169PLS-8M-4R	8	1/4	14	23.50	24.00
169PLS-8M-6R	8	3/8	19	23.00	25.00
169PLS-10M-4R	10	1/4	17	27.00	31.00
169PLS-10M-6R	10	3/8	19	26.00	31.00
169PLS-12M-4R	12	1/4	22	31.50	33.00
169PLS-12M-6R	12	3/8	22	32.50	33.00
169PLS-12M-8R	12	1/2	22	27.50	33.00

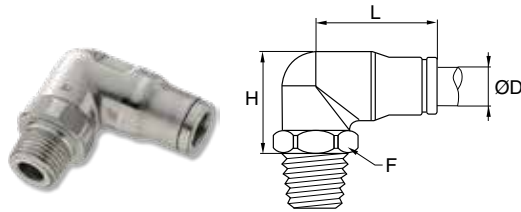

169PLS Male Elbow - Metric Tube to NPT

PART NO.	TUBE SIZE MM	NPT	F MM	H MM	L MM
169PLS-6M-2	6	1/8	13	20.00	22.50
169PLS-6M-4	6	1/4	14	20.00	22.50
169PLS-8M-2	8MM(5/16)	1/8	13	25.00	24.00
169PLS-8M-4	8MM(5/16)	1/4	14	24.00	24.00
169PLS-10M-4	10	1/4	17	27.50	27.50
169PLS-10M-6	10	3/8	19	28.50	26.50
169PLS-12M-4	12	1/4	22	31.50	32.50
169PLS-12M-6	12	3/8	22	32.50	32.50
169PLS-12M-8	12	1/2	22	27.50	32.50

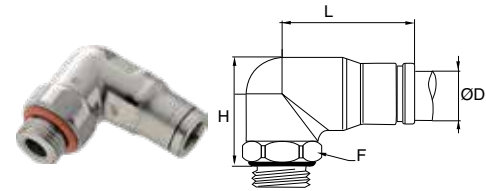

169PLS Male Elbow - Metric Tube to BSPP

PART NO.	TUBE SIZE MM	BSPP	F MM	H MM	L MM
169PLS-4M-2G	4	1/8	10	22	19
169PLS-4M-4G	4	1/4	17	20	19
169PLS-6M-2G	6	1/8	13	24	24
169PLS-6M-4G	6	1/4	17	22	24
169PLS-8M-2G	8	1/8	13	25	25
169PLS-8M-4G	8	1/4	17	25	25
169PLS-8M-6G	8	3/8	21	23	25
169PLS-10M-4G	10	1/4	18	29	31
169PLS-10M-6G	10	3/8	21	27	31
169PLS-12M-4G	12	1/4	17	33	33
169PLS-12M-6G	12	3/8	21	33	33
169PLS-12M-8G	12	1/2	24	30	33

WARNING These products can expose you to chemicals including NICKEL, which is known to the state of California to cause cancer. For more information go to www.P65Warnings.ca.gov.

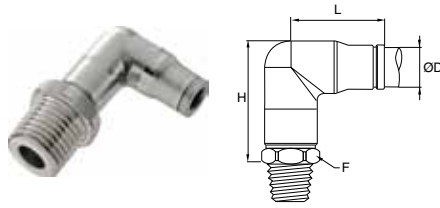

169PLSX Extended Male Elbow - Metric Tube to NPT

PART NO.	TUBE SIZE MM	NPT	F MM	H MM	L MM
169PLSX-4M-2	4	1/8	11	25.5	18.5
169PLSX-6M-2	6	1/8	13	29	22.5
169PLSX-6M-4	6	1/4	14	29	22.5
169PLSX-8M-2	8	1/8	14	34	24
169PLSX-8M-4	8	1/4	14	34	24
169PLSX-10M-4	10	1/4	19	39.5	30
169PLSX-10M-6	10	3/8	19	39.5	30

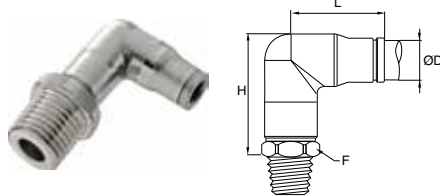

169PLSX Extended Male Elbow - Metric Tube to BSPT

PART NO.	TUBE SIZE MM	BSPT	F MM	H MM	L MM
169PLSX-4M-2R	4	1/8	10	25	19.00
169PLSX-4M-4R	4	1/4	14	26	19.00
169PLSX-6M-2R	6	1/8	13	30	24.00
169PLSX-6M-4R	6	1/4	14	30	24.00
169PLSX-8M-2R	8	1/8	14	34	24.90
169PLSX-8M-4R	8	1/4	14	34	24.90
169PLSX-10M-4R	10	1/4	19	39	31.00
169PLSX-10M-6R	10	3/8	19	39	31.00

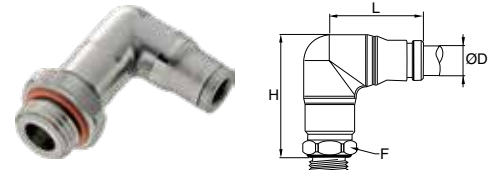

169PLSX Extended Male Elbow - Metric Tube to BSPP, M5

PART NO.	TUBE SIZE MM	BSPP / M5	F MM	H MM	L MM
169PLSX-4M-M5	4	M5X0.8	10	27.00	19
169PLSX-4M-2G	4	1/8	13	27.00	19
169PLSX-4M-4G	4	1/4	17	27.00	19
169PLSX-6M-M5	6	M5X0.8	13	33.00	24
169PLSX-6M-2G	6	1/8	13	33.00	24
169PLSX-6M-4G	6	1/4	17	32.00	24
169PLSX-8M-2G	8	1/8	14	35.00	25
169PLSX-8M-4G	8	1/4	17	35.00	25
169PLSX-8M-6G	8	3/8	21	34.50	25
169PLSX-10M-4G	10	1/4	18	43.00	31
169PLSX-10M-6G	10	3/8	21	42.00	31

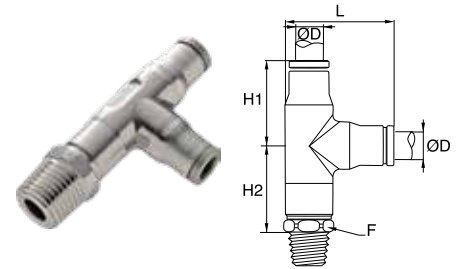

171PLS Male Run Tee - Metric Tube to NPT

PART NO.	TUBE SIZE MM	NPT	F MM	H1 MM	H2 MM	L MM
171PLS-4M-2	4MM(5/32)	1/8	11	19.00	21.00	25.00
171PLS-8M-2	8MM(5/16)	1/8	14	24.00	26.50	30.50

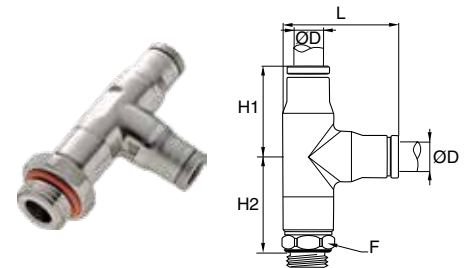

171PLS Male Run Tee - Metric Tube to BSPP, M5

PART NO.	TUBE SIZE MM	BSPP / M5	F MM	H1 MM	H2 MM	L MM
171PLS-8M-6G	8	3/8	21	25.00	27.30	35.50
171PLS-10M-4G	10	1/4	18	31.00	35.60	39.60

WARNING These products can expose you to chemicals including NICKEL, which is known to the state of California to cause cancer. For more information go to www.P65Warnings.ca.gov.



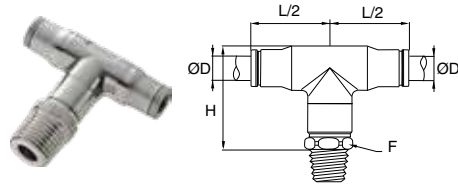

172PLS Male Branch Tee - Metric Tube to NPT

PART NO.	TUBE SIZE MM	NPT	F MM	H MM	L/2 MM
172PLS-8M-2	8MM(5/16)	1/8	14	34.00	24.00
172PLS-8M-4	8MM(5/16)	1/4	14	34.00	24.00
172PLS-10M-4	10	1/4	19	40.00	29.50
172PLS-10M-6	10	3/8	19	40.00	29.50

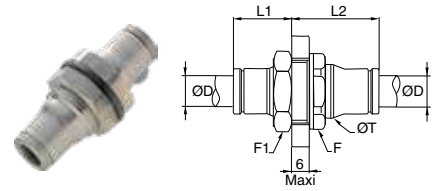

62PLSBH Bulkhead Union - Inch Tube

PART NO.	TUBE SIZE IN	F MM	F1 MM	L1 IN	L2 IN	T IN
62PLSBH-3	3/16	17	13	.59	.83	.49
62PLSBH-4	1/4	19	17	.67	.89	.59
62PLSBH-6	3/8	27	22	.87	1.08	.82
62PLSBH-8	1/2	27	27	.94	1.14	.98

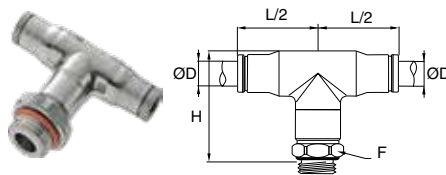

172PLS Male Branch Tee - Metric Tube to BSPP, M5

PART NO.	TUBE SIZE MM	BSPP / M5	F MM	H MM	L/2 MM
172PLS-4M-M5	4	M5X0.8	10	26.80	19
172PLS-6M-M5	6	M5X0.8	13	33.50	24
172PLS-8M-4G	8	1/4	17	35.00	25
172PLS-10M-4G	10	1/4	18	43.20	31

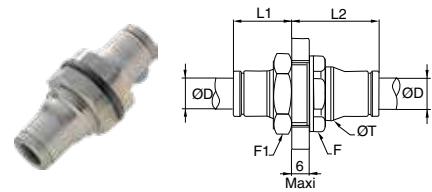

62PLSBH Bulkhead Union - Metric Tube

PART NO.	TUBE SIZE MM	F MM	F1 MM	L1 MM	L2 MM	T MM
62PLSBH-4M	4MM(5/32)	14	13	15	18	13
62PLSBH-6M	6	17	17	19	21	15
62PLSBH-8M	8MM(5/16)	19	19	20	22	17
62PLSBH-10M	10	22	22	24	26	21
62PLSBH-12M	12	24	24	25	26	23

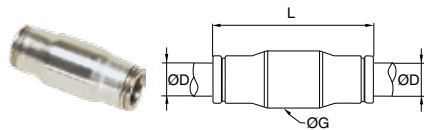

62PLS Union - Inch Tube

PART NO.	TUBE SIZE IN	G IN	H IN
62PLS-3	3/16	.39	1.18
62PLS-4	1/4	.47	1.38
62PLS-6	3/8	.69	1.81
62PLS-8	1/2	.79	1.89

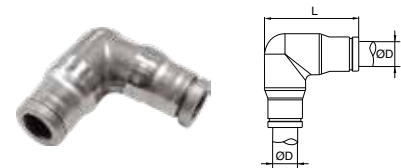

165PLS Union Elbow - Inch Tube

PART NO.	TUBE SIZE IN	L IN
165PLS-4	1/4	1.14
165PLS-6	3/8	1.56
165PLS-8	1/2	1.61

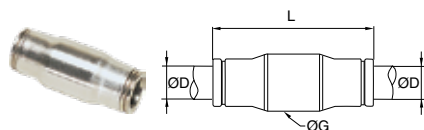

62PLS Union - Metric Tube

PART NO.	TUBE SIZE MM	G MM	H MM
62PLS-4M	4MM(5/32)	10.00	30.00
62PLS-6M	6	12.00	37.00
62PLS-8M	8MM(5/16)	15.00	38.00
62PLS-10M	10	17.00	49.00
62PLS-12M	12	19.50	49.50

WARNING These products can expose you to chemicals including NICKEL, which is known to the state of California to cause cancer. For more information go to www.P65Warnings.ca.gov.

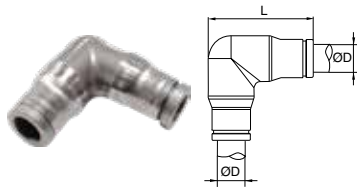

165PLS Union Elbow - Metric Tube

PART NO.	TUBE SIZE MM	L MM
165PLS-4M	4MM(5/32)	24.00
165PLS-6M	6	30.00
165PLS-8M	8MM(5/16)	32.20
165PLS-10M	10	39.00
165PLS-12M	12	43.00

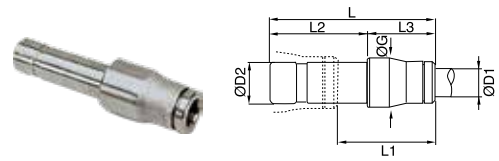

67PLS Tube Reducer - Metric

PART NO.	TUBE 1 SIZE MM	TUBE 2 SIZE MM	G MM	L MM	L1 MM	L2 MM	L3 MM
67PLS-4M-6M	4	6	10	35	19.0	19	16
67PLS-4M-8M	4	8	10	34	17.0	20	14
67PLS-6M-8M	6	8	12	42	24.0	23	19
67PLS-6M-10M	6	10	12	42	19.0	25	17
67PLS-8M-10M	8	10	15	45	22.5	25	19
67PLS-8M-12M	8	12	15	43	20.0	26	17
67PLS-10M-12M	10	12	17	51	23.0	26	25

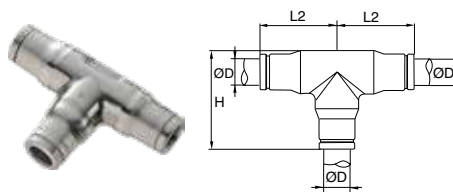

164PLS Union Tee - Inch Tube

PART NO.	TUBE SIZE IN	H IN	L2 IN
164PLS-4	1/4	1.06	.83
164PLS-6	3/8	1.48	1.12
164PLS-8	1/2	1.61	1.22

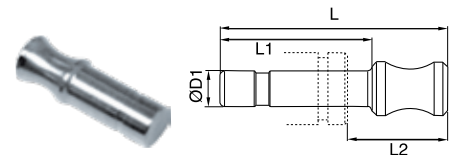

639PLS Plug - Metric

PART NO.	TUBE 1 SIZE MM	L MM	L1 MM	L2 MM
639PLS-4M	4	25.40	17.00	11.10
639PLS-6M	6	30.40	19.50	13.50
639PLS-8M	8	33.00	20.00	14.40
639PLS-10M	10	40.00	25.00	17.00
639PLS-12M	12	43.00	26.00	18.70

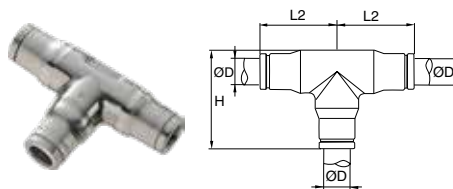

164PLS Union Tee - Metric Tube

PART NO.	TUBE SIZE MM	H MM	L2 MM
164PLS-4M	4MM(5/32)	24	19
164PLS-6M	6	30	24
164PLS-8M	8MM(5/16)	32	25
164PLS-10M	10	39	31
164PLS-12M	12	43	33

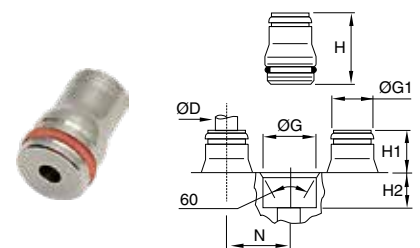

PLSC Cartridge - Metric

PART NO.	TUBE SIZE MM	G +.1 - 0 MM	G1 MM	H MM	H1 MM	H2 MM	N MM
PLSC-4M	4	9.80	8	18.00	9.50	8.50	11.00
PLSC-6M	6	12.10	10	20.00	11.50	8.50	13.50
PLSC-8M	8	14.80	13	22.00	13.50	8.50	16.00
PLSC-10M	10	17.50	15	25.50	15.00	10.50	20.00

WARNING These products can expose you to chemicals including NICKEL, which is known to the state of California to cause cancer. For more information go to www.P65Warnings.ca.gov.

Oscillating Elbows



Parker's oscillating fittings are designed to satisfy the requirements of industrial automation and robotics. The oscillating fitting features low-friction washers enabling the fitting to rotate in conjunction with the stroke of the cylinder piston.

Product Features:

- Glass reinforced nylon 6.6 body
- Nylon collar
- Stainless Steel gripping ring
- Nitrile D seal
- Nitrile o-ring
- Nickel-plated brass threads

Markets:

- Robotics
- Pneumatics
- Textile
- Packaging
- Semi-conductors

Applications:

- Air
- Cutting Fluids
- Inert Gases

Specifications:

Pressure Range Up to 290 PSI (19.9 bar)
depending on tubing

Temperature Range -4° to +175° F (-20° to +79.4° C)

Compatible Tubing:

- Semi-rigid nylon
- Polyurethane 95 Durometer Shore A
- Nylon
- Fluoropolymer

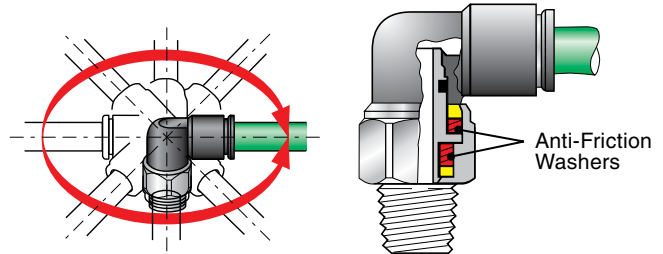

O.D. TUBE INCH & MM	5/32 & 4	1/4 & 6	8	10	12
"MAXIMUM ROTATION SPEED IN RADIAN/SECOND"	190	160	120	90	80

Assembly Instructions

1. Cut tubing squarely – maximum of 15° angle allowable.
2. Check that port or mating part is clean and free of debris.
3. Mark tubing to appropriate tube insertion length. (see Tube Insertion Chart on page N22)
4. Insert tubing until it bottoms
5. Pull on tubing to verify it is fully inserted
6. To disassemble, simply press release button, hold against body and pull tubing out of fitting.

WARNING These products can expose you to chemicals including LEAD which is known to the state of California to cause cancer and birth defects or other reproductive harm. For more information go to www.P65Warnings.ca.gov.



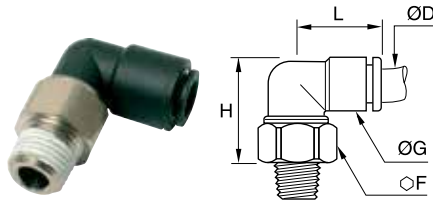

W369PLPO Oscillating Compact Elbow - NPT

PART NO.	TUBE SIZE IN	NPT	F	G	H	L
W369PLPO-4M-2	5/32(4MM)	1/8	12	.43	.85	.69
W369PLPO-4-2	1/4	1/8	14	.55	1.04	.81
W369PLPO-4-4	1/4	1/4	14	.55	1.04	.81

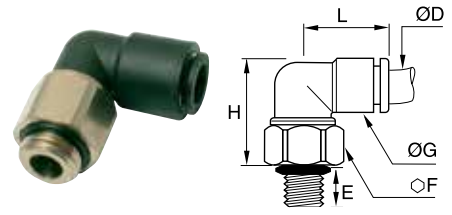

369PLPO Oscillating Compact Elbow - BSPP, M5

PART NO.	TUBE SIZE MM	M5/ BSPP	E	F	G	H	L
369PLPO-4M-M5	4	M5X0.8	3.0	12	11.0	24.5	17.5
369PLPO-4M-2G	4	1/8	5.0	13	11.0	23.0	17.5
369PLPO-6M-M5	6	M5X0.8	3.0	12	14.0	27.5	20.5
369PLPO-6M-2G	6	1/8	5.0	14	14.0	27.0	20.5
369PLPO-6M-4G	6	1/4	5.5	16	14.0	25.5	20.5
369PLPO-8M-2G	8	1/8	5.0	17	16.0	33.5	23.5
369PLPO-8M-4G	8	1/4	5.5	17	16.0	31.0	23.5
369PLPO-8M-6G	8	3/8	5.5	20	16.0	29.5	23.5
369PLPO-10M-4G	10	1/4	5.5	19	19.5	50.0	29.0
369PLPO-10M-6G	10	3/8	5.5	20	19.5	37.0	29.0
369PLPO-12M-4G	12	1/4	5.5	21	22.0	46.5	33.5
369PLPO-12M-6G	12	3/8	5.5	21	22.0	45.5	33.5

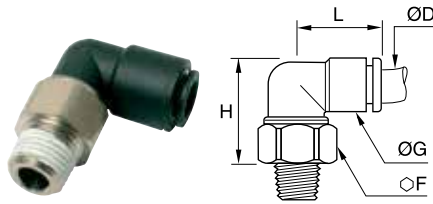

W369PLPO Oscillating Compact Elbow - BSPT

PART NO.	TUBE SIZE MM	BSPT	F	G	H	L
W369PLPO-4M-2R	4	1/8	12	11.0	22.0	17.5
W369PLPO-6M-2R	6	1/8	14	14.0	26.5	20.5
W369PLPO-6M-4R	6	1/4	14	14.0	23.5	20.5
W369PLPO-8M-2R	8	1/8	17	16.0	32.0	23.5
W369PLPO-8M-4R	8	1/4	17	16.0	29.0	23.5
W369PLPO-8M-6R	8	3/8	17	16.0	25.0	23.5
W369PLPO-10M-4R	10	1/4	19	19.5	37.5	29.0
W369PLPO-10M-6R	10	3/8	19	19.5	33.5	29.0
W369PLPO-12M-4R	12	1/4	21	22.0	44.5	33.5
W369PLPO-12M-6R	12	3/8	21	22.0	41.0	33.5

WARNING These products can expose you to chemicals including LEAD which is known to the state of California to cause cancer and birth defects or other reproductive harm. For more information go to www.P65Warnings.ca.gov.



Pneumatic: Integrated Fittings

Compact Flow Controls

Miniature Flow Controls

Swivel Outlet Flow Controls

Plug-In Flow Controls

In-Line Flow Controls

Metal Flow Controls

Stainless Steel
Flow Controls

In-Line Check Valves

Stainless Steel Check Valves

Piloted Operated Check Valves

Pneumatic Slide Valves

Quick Exhaust Valve

Blocking Valves

Slow Start Valves























Threshold Sensor Fittings

Mini Ball Valves



Compact Flow Controls	FCC731 Meter Out	FCC731 Meter Out - BSPT	FCC731 Meter Out - BSPP	FCCI731 Meter In	FCCI731 Meter In - BSPT	FCCI731 Meter In - BSPP
	 p. B7	 p. B7	 p. B7	 p. B7	 p. B7	 p. B7
FCCB731 Bi-Directional	FCCB731 Bi-Directional - BSPT	FCCB731 Bi-Directional - BSPP	FCKC731 Meter Out Knobless	FCKC731 Meter Out Knobless - BSPP	FCKCI731 Meter In Knobless	FCKCI731 Meter In Knobless - BSPP
 p. B8	 p. B8	 p. B8	 p. B8	 p. B8	 p. B9	 p. B9
FCKCB731 Bi-directional Knobless - BSPP	FCK701C Knobless Compression Metal - BSPP	Miniature Flow Controls	FCM731 Meter Out	FCMI731 Meter In	FCM731 Meter Out - BSPT	FCMI731 Meter In - BSPT
 p. B9	 p. B9		 p. B11	 p. B11	 p. B11	 p. B11
FCM731 Meter Out - BSPP	FCMI731 Meter In - BSPP	FCMB731 Bi-directional - BSPP	FCMK731 Meter Out Knobless	Swivel Outlet Flow Controls	FCCS731 Meter Out	FCMS731 Meter Out Miniature
 p. B11	 p. B12	 p. B12	 p. B12		 p. B14	 p. B14
FCMS731 Meter Out Miniature - BSPT	FCMS731 Meter Out Miniature - BSPP	FCMSI731 Meter In Miniature - BSPP	FCCS731 Meter Out - BSPP			
 p. B14	 p. B15	 p. B15	 p. B15			
Plug-In Flow Controls	FCMSP731 Meter Out miniature	FCMSPI731 Meter In Miniature	FCMSP701 Meter Out miniature	FCMSPI731 Meter In Miniature	FCCSP731 Meter Out Compact	FCCSPI731 Meter In Compact
	 p. B17	 p. B17	 p. B17	 p. B17	 p. B17	 p. B17
In-Line Flow Controls	FC832 In-Line	FCB832 Bi-directional	FC832 In-Line Metric	FCB832 Bi-directional Metric	FCPM832 Panel Mountable	FC836 Threaded In-Line
	 p. B19	 p. B19	 p. B19	 p. B19	 p. B20	 p. B20
FC836 Threaded In-Line Metric	Metal Flow Controls	FC705 Meter Out	FC701 Meter Out - BSPP	FCI701 Meter In - BSPP	FC708 Meter Out	FC702 Meter Out - BSPP
 p. B20		 p. B22	 p. B22	 p. B22	 p. B22	 p. B22

WARNING These products can expose you to chemicals including NICKEL or LEAD, which are known to the state of California to cause cancer, and LEAD which is known to cause birth defects or other reproductive harm. For more information go to www.P65Warnings.ca.gov.

<p>FCI702 Meter In - BSPP</p>  <p>p. B22</p>	<p>Stainless Steel Flow Controls</p>		<p>7810 Meter Out - BSPP</p>  <p>p. B24</p>	<p>7812 Bi-directional BSPP</p>  <p>p. B24</p>	<p>7810,7815 Meter Out - NPT</p>  <p>p. B24</p>	<p>7812, 7817 Bi-directional NPT</p>  <p>p. B24</p>	<p>7835 Meter Out NPT</p>  <p>p. B24</p>	
<p>Check Valves</p>			<p>32PLCK In-Line</p>  <p>p. B26</p>	<p>32PLCK In-Line - Metric</p>  <p>p. B26</p>	<p>W68PLCK Meter Out</p>  <p>p. B26</p>	<p>W68PLCKI Meter In</p>  <p>p. B26</p>	<p>W68PLCK Meter Out - BSPT</p>  <p>p. B26</p>	<p>W68PLCKI Meter In - BSPT</p>  <p>p. B26</p>
<p>68PLCK Meter Out - BSPP</p>  <p>p. B27</p>	<p>68PLCKI Meter In - BSPP</p>  <p>p. B27</p>	<p>VC Check Valve</p>  <p>p. B27</p>	<p>Stainless Steel Check Valves</p>		<p>4890 Unidirectional BSPP</p>  <p>p. B29</p>	<p>4895 Unidirectional NPT</p>  <p>p. B29</p>	<p>4891 Male x Female BSPP</p>  <p>p. B29</p>	
<p>Pilot Operated Check Valves</p>					<p>7892 BSPP</p>  <p>p. B31</p>	<p>7894 Regulator & Exhaust BSPP</p>  <p>p. B31</p>	<p>Pneumatic Slide Valves</p>	
<p>0669 Female BSPP</p>  <p>p. B33</p>	<p>Quick Exhaust</p>		<p>7982 NPT</p>  <p>p. B34</p>	<p>Blocking Valves</p>		<p>FC601 Lock Out</p>  <p>p. B36</p>		
<p>FC602 Lock Out</p>  <p>p. B36</p>	<p>FC608 Lock Out - BSPT</p>  <p>p. B36</p>	<p>FC608 Lock Out - BSPP</p>  <p>p. B36</p>	<p>Slow Start Valves</p>			<p>FC908 System Isolating</p>  <p>p. B38</p>	<p>FC908 Isolated Component - BSPP</p>  <p>p. B38</p>	<p>FCIC908 Isolated Component - BSPP</p>  <p>p. B38</p>
<p>Threshold Sensor</p>					<p>PSBJ731 Pneumatic 5/32 Pilot</p>  <p>p. B40</p>	<p>PSBJ731 Pneumatic 4mm Pilot</p>  <p>p. B40</p>	<p>PSPJ731 Pneumatic 10-32 Pilot</p>  <p>p. B40</p>	<p>PSBJ708 Pneumatic M5 Pilot</p>  <p>p. B40</p>
<p>Mini Ball Valve</p>			<p>MVV309 Push-to-Connect Ports</p>  <p>p. B42</p>	<p>MV308 Male BSPP</p>  <p>p. B42</p>	<p>MV309 Push-to-Connect Ports, Vented</p>  <p>p. B42</p>	<p>MVV308 Male BSPP, Vented</p>  <p>p. B42</p>	<p>MVV308 Male NPT, Vented</p>  <p>p. B42</p>	

WARNING These products can expose you to chemicals including NICKEL or LEAD, which are known to the state of California to cause cancer, and LEAD which is known to cause birth defects or other reproductive harm. For more information go to www.P65Warnings.ca.gov.

Compact Flow Controls



Parker's compact flow controls ensure excellent performance of flow and are perfectly suited for reduced spaces due to their small size.

Product Features:

- Glass reinforced nylon 6.6 body
- Stainless steel gripping ring
- Nickel-plated brass adjustment screw
- Nickel-plated brass locking nut
- Nickel-plated brass threads
- Nitrile D seal
- NPT
- BSPT
- BSPP
- Metric threads

Markets:

- Factory/Process Automation
- Life Science
- Food Processing
- Water And Beverage
- Petrochemical

Applications:

- Packaging
- Filling
- Dispensing
- Bottling
- Pneumatic Circuits

Specifications:

Pressure Range 15 to 145 psi (1.0 to 9.9 bar)

Temperature Range +30° to +160° F (-1.1 to +71.1° C)

Compatible Tubing:

- Semi-rigid nylon
- Polyurethane 95 Durometer Shore A
- Nylon
- Fluoropolymer

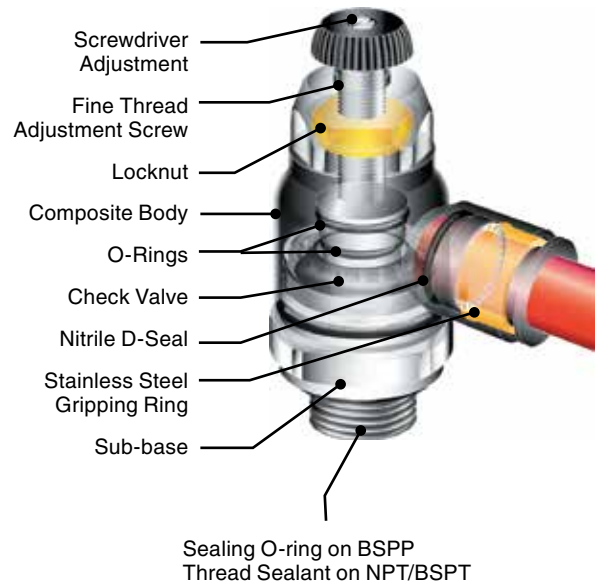

Assembly Instructions

1. Cut tubing squarely – maximum of 15° angle allowable.
2. Check that port or mating part is clean and free of debris.
3. Mark tubing to appropriate tube insertion length. (see Tube Insertion Chart on page N22)
4. Insert tubing until it bottoms
5. Pull on tubing to verify it is fully inserted
6. To disassemble, simply press release button, hold against body and pull tubing out of fitting.



WARNING These products can expose you to chemicals including NICKEL or LEAD, which are known to the state of California to cause cancer, and LEAD which is known to cause birth defects or other reproductive harm. For more information go to www.P65Warnings.ca.gov.



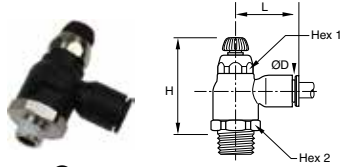

FCC731 Compact Meter Out

PART NO.	TUBE SIZE IN	NPT	HEX 1	HEX 2	H OPEN	H CLOSED	L
FCC731-4M-2	5/32(4MM)	1/8	.63	.39	1.67	1.44	.85
FCC731-4M-4	5/32(4MM)	1/4	.63	.39	1.67	1.44	.85
FCC731-4-2	1/4	1/8	.63	.39	1.67	1.44	.85
FCC731-4-4	1/4	1/4	.63	.39	1.67	1.44	.85
FCC731-6-4	3/8	1/4	.91	.67	2.03	1.71	1.22
FCC731-6-6	3/8	3/8	.91	.67	2.03	1.71	1.22
FCC731-6-8	3/8	1/2	.67	.91	2.03	1.71	1.22
FCC731-8-8	1/2	1/2	.67	.91	2.03	1.71	1.22

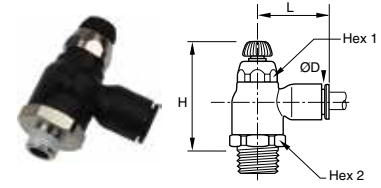

FCCI731 Compact Meter In Flow Control

PART NO.	TUBE SIZE IN	NPT	HEX 1	HEX 2	H OPEN	H CLOSED	L
FCCI731-4M-2	5/32(4MM)	1/8	.63	.39	1.67	1.44	.85
FCCI731-4M-4	5/32(4MM)	1/4	.63	.39	1.67	1.44	.85
FCCI731-4-2	1/4	1/8	.63	.39	1.67	1.44	.85
FCCI731-4-4	1/4	1/4	.63	.39	1.67	1.44	.85

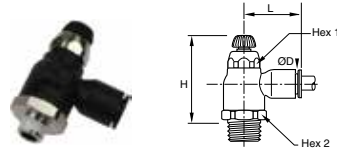

FCC731 Compact Meter Out - BSPT

PART NO.	TUBE SIZE MM	BSPT	HEX 1	HEX 2	H CLOSED	H OPEN	L
FCC731-6M-2R	6	1/8	16	10	36.5	42.5	22.0
FCC731-8M-2R	8	1/8	19	14	40.0	45.0	27.0
FCC731-8M-4R	8	1/4	19	14	40.0	45.0	27.0
FCC731-10M-4R	10	1/4	23	17	43.5	51.5	31.5
FCC731-10M-6R	10	3/8	23	17	43.5	51.5	31.5
FCC731-10M-8R	10	1/2	23	17	43.5	51.5	31.5
FCC731-12M-4R	12	1/4	23	17	43.5	51.5	35.0
FCC731-12M-6R	12	3/8	23	17	43.5	51.5	35.0
FCC731-12M-8R	12	1/2	23	17	43.5	51.5	35.0

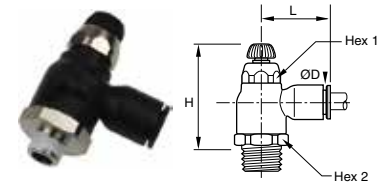

FCCI731 Compact Meter In Flow Control - BSPT

PART NO.	TUBE SIZE MM	BSPT	HEX 1	HEX 2	H CLOSED	H OPEN	L
FCCI731-10M-4R	10	1/4	23	17	43.5	51.5	31.5
FCCI731-10M-8R	10	1/2	23	17	43.5	51.5	31.5

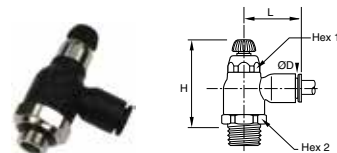

FCC731 Compact Meter Out - BSPP

PART NO.	TUBE SIZE MM	BSPP	HEX 1	HEX 2	H CLOSED	H OPEN	L
FCC731-4M-2G	4	1/8	10	16	38.0	44.0	22.0
FCC731-6M-2G	6	1/8	10	16	38.0	44.0	22.0
FCC731-6M-4G	6	1/4	10	16	36.5	42.5	22.0
FCC731-8M-2G	8	1/8	14	19	41.5	48.0	28.0
FCC731-8M-4G	8	1/4	14	19	41.5	48.0	28.0
FCC731-8M-6G	8	3/8	14	19	41.5	48.0	28.0
FCC731-10M-4G	10	1/4	17	23	45.5	53.5	31.5
FCC731-10M-6G	10	3/8	17	23	45.5	54.0	31.5
FCC731-12M-6G	12	3/8	17	23	45.5	54.0	35.0
FCC731-12M-8G	12	1/2	17	24	45.5	54.0	35.0

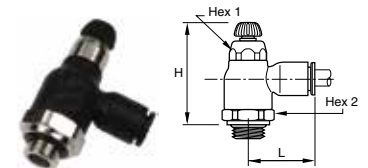

FCCI731 Compact Meter In Flow Control - BSPP

PART NO.	TUBE SIZE MM	BSPP	HEX 1	HEX 2	H CLOSED	H OPEN	L
FCCI731-4M-2G	4	1/8	10	16	38.0	44.0	22.0
FCCI731-6M-2G	6	1/8	10	16	38.0	44.0	22.0
FCCI731-6M-4G	6	1/4	10	16	36.5	42.5	22.0
FCCI731-8M-2G	8	1/8	14	19	41.5	48.0	28.0
FCCI731-8M-4G	8	1/4	14	19	41.5	48.0	28.0
FCCI731-8M-6G	8	3/8	14	19	41.5	48.0	28.0
FCCI731-10M-4G	10	1/4	17	23	45.5	53.5	31.5
FCCI731-10M-6G	10	3/8	17	23	45.5	54.0	31.5
FCCI731-12M-8G	12	1/2	17	24	45.5	54.0	35.0

WARNING These products can expose you to chemicals including NICKEL or LEAD, which are known to the state of California to cause cancer, and LEAD which is known to cause birth defects or other reproductive harm. For more information go to www.P65Warnings.ca.gov.

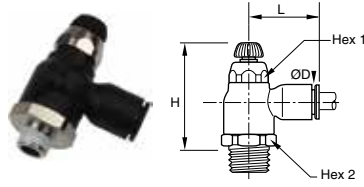

FCCB731 Compact Bi-Directional Flow Control

PART NO.	TUBE SIZE IN	NPT	HEX 1	HEX 2	H OPEN	H CLOSED	L
FCCB731-4M-2	5/32(4MM)	1/8	.63	.39	1.67	1.44	.85
FCCB731-4-2	1/4	1/8	.63	.39	1.67	1.44	.85
FCCB731-4-4	1/4	1/4	.63	.39	1.67	1.44	.85

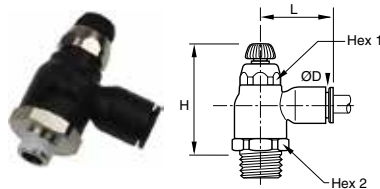

FCCB731 Compact Bi-directional Flow Control - BSPT

PART NO.	TUBE SIZE MM	BSPT	HEX 1	HEX 2	H CLOSED	H OPEN	L
FCCB731-4M-2R	4	1/8	16	10	36.5	42.5	22.0
FCCB731-6M-2R	6	1/8	16	10	36.5	42.5	22.0
FCCB731-6M-4R	6	1/4	16	10	36.5	42.5	22.0
FCCB731-8M-2R	8	1/8	19	14	40.0	45.0	27.0
FCCB731-8M-4R	8	1/4	19	14	40.0	45.0	27.0
FCCB731-8M-6R	8	3/8	19	14	40.0	45.0	27.0

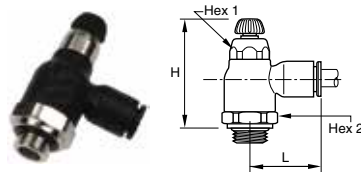

FCCB731 Compact Bi-directional Flow Control - BSPP

PART NO.	TUBE SIZE MM	BSPP	HEX 1	HEX 2	H CLOSED	H OPEN	L
FCCB731-4M-2G	4	1/8	10	16	38.0	44.0	22.0
FCCB731-6M-2G	6	1/8	10	16	38.0	44.0	22.0
FCCB731-6M-4G	6	1/4	10	16	36.5	42.5	22.0
FCCB731-8M-2G	8	1/8	14	19	41.5	48.0	28.0
FCCB731-8M-4G	8	1/4	14	19	41.5	48.0	28.0
FCCB731-8M-6G	8	3/8	14	19	41.5	48.0	28.0

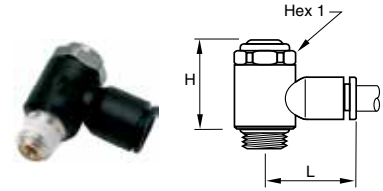

FCKC731 Knobless Meter Out Flow Control

ART NO.	TUBE SIZE IN	NPT / UNF	HEX 1 MM	H	L
FCKC731-2-0	1/8	10-32		.69	.65
FCKC731-2-2	1/8	1/8	13	.79	.75
FCKC731-4M-0	5/32(4MM)	10-32		.69	.65
FCKC731-4M-2	5/32(4MM)	1/8	13	.79	.75
FCKC731-4-0	1/4	10-32		.69	.77
FCKC731-4-2	1/4	1/8	13	.79	.85
FCKC731-4-4	1/4	1/4	17	1.04	.89
FCKC731-8M-2	5/16(8MM)	1/8	13	.79	1.02
FCKC731-8M-4	5/16(8MM)	1/4	17	1.04	1.06
FCKC731-6-4	3/8	1/4	17	1.04	1.14
FCKC731-6-6	3/8	3/8	20	1.14	1.36

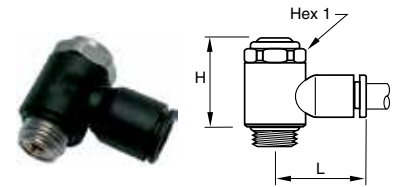

FCKC731 Knobless Compact Flow Control - BSPP

PART NO.	TUBE SIZE MM	BSPP / M5	HEX 1	H	L
FCKC731-4M-M5	4	M5X0.8	8.0	17.5	17.0
FCKC731-4M-2G	4	1/8	13.0	25.0	19.0
FCKC731-6M-M5	6	M5X0.8	8.0	17.5	19.0
FCKC731-6M-2G	6	1/8	13.0	25.0	21.0
FCKC731-6M-4G	6	1/4	17.0	26.5	22.0
FCKC731-8M-2G	8	1/8	13.0	25.0	26.0
FCKC731-8M-4G	8	1/4	17.0	26.5	27.0
FCKC731-8M-6G	8	3/8	20.0	37.5	29.0
FCKC731-10M-4G	10	1/4	17.0	26.5	29.0
FCKC731-10M-6G	10	3/8	20.0	37.5	31.0
FCKC731-10M-8G	10	1/2	23.0	43.0	37.0
FCKC731-12M-6G	12	3/8	20.0	37.5	6.8
FCKC731-12M-8G	12	1/2	23.0	43.0	37.0

WARNING These products can expose you to chemicals including NICKEL or LEAD, which are known to the state of California to cause cancer, and LEAD which is known to cause birth defects or other reproductive harm. For more information go to www.P65Warnings.ca.gov.

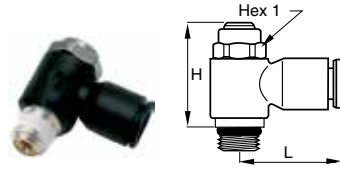

FCKCI731 Knobless Meter In Flow Control

PART NO.	TUBE SIZE IN	NPT / UNF	HEX 1 MM	H	L
FCKCI731-4M-0	5/32(4MM)	10-32	8	.69	.65
FCKCI731-4M-2	5/32(4MM)	1/8	13	.79	.75
FCKCI731-4-0	1/4	10-32	8	.69	.77
FCKCI731-4-2	1/4	1/8	13	.79	.85
FCKCI731-4-4	1/4	1/4	17	1.04	.89

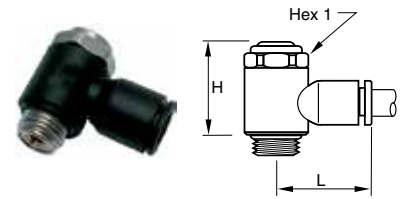

FCKCB731 Knobless Bi-directional Flow Control - BSPP

PART NO.	TUBE SIZE MM	BSPP / M5	HEX 1	H	L
FCKCB731-4M-M5	4	M5X0.8	8	17.5	17.0
FCKCB731-4M-2G	4	1/8	13	25.0	19.0
FCKCB731-6M-M5	6	M5X0.8	8	17.5	19.0
FCKCB731-6M-2G	6	1/8	13	25.0	21.0
FCKCB731-6M-4G	6	1/4	17	26.5	22.0
FCKCB731-8M-2G	8	1/8	13	25.0	26.0
FCKCB731-8M-4G	8	1/4	17	26.5	27.0
FCKCB731-8M-6G	8	3/8	20	37.5	29.0

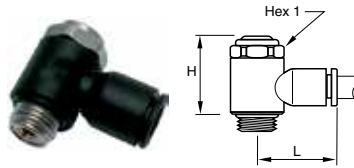

FCKCI731 Knobless Compact Meter In Flow Control-BSPP

PART NO.	TUBE SIZE MM	BSPP / M5	HEX 1	H	L
FCKCI731-4M-M5	4	M5X0.8	8.0	17.5	17.0
FCKCI731-4M-2G	4	1/8	13.0	25.0	19.0
FCKCI731-6M-M5	6	M5X0.8	8.0	17.5	19.0
FCKCI731-6M-2G	6	1/8	13.0	25.0	21.0
FCKCI731-6M-4G	6	1/4	17.0	26.5	22.0
FCKCI731-8M-2G	8	1/8	13.0	25.0	26.0
FCKCI731-8M-4G	8	1/4	17.0	26.5	27.0
FCKCI731-8M-6G	8	3/8	20.0	37.5	29.0
FCKCI731-10M-4G	10	1/4	17.0	26.5	29.0
FCKCI731-10M-6G	10	3/8	20.0	37.5	31.0

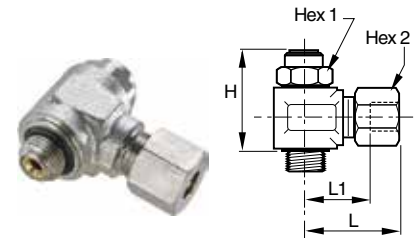

FCK701C Knobless Compression Metal Flow Control - BSPP

PART NO.	TUBE SIZE MM	BSPP	HEX 1	HEX 2	H	L	L1
FCK701C-4M-2G	4	1/8	13	10	26.0	25.5	14.5
FCK701C-6M-2G	6	1/8	13	13	26.0	25.5	14.5
FCK701C-6M-4G	6	1/4	17	13	31.5	28.5	17.5
FCK701C-8M-2G	8	1/8	13	14	26.0	29.5	15.5
FCK701C-8M-4G	8	1/4	17	14	31.5	31.0	17.0
FCK701C-10M-4G	10	1/4	17	19	31.5	35.0	19.0
FCK701C-10M-6G	10	3/8	20	19	44.5	37.5	19.0
FCK701C-10M-8G	10	1/2	23	19	50.0	37.5	19.0
FCK701C-12M-8G	12	1/2	23	22	50.0	38.0	21.5

WARNING These products can expose you to chemicals including NICKEL or LEAD, which are known to the state of California to cause cancer, and LEAD which is known to cause birth defects or other reproductive harm. For more information go to www.P65Warnings.ca.gov.

Miniature Flow Controls



Parker's miniature flow controls ensure excellent performance of flow and are perfectly suited for reduced spaces due to their small size.

Product Features:

- Glass reinforced nylon 6.6 body
- Stainless steel gripping ring
- Nickel-plated brass adjustment screw
- Nickel-plated brass locking nut
- Nickel-plated brass threads
- Nitrile D seal
- NPT, BSPT, BSPP, Metric threads

Markets:

- Factory/Process Automation
- Life Science
- Food Processing
- Water And Beverage
- Petrochemical

Applications:

- Packaging
- Filling
- Dispensing
- Bottling
- Pneumatic Circuits

Specifications:

Pressure Range 15 to 145 psi (1.0 to 9.9 bar)

Temperature Range +30° to +160° F (-1.1 to +71.1° C)

Compatible Tubing:

- Semi-rigid nylon
- Polyurethane 95 Durometer Shore A
- Nylon
- Fluoropolymer

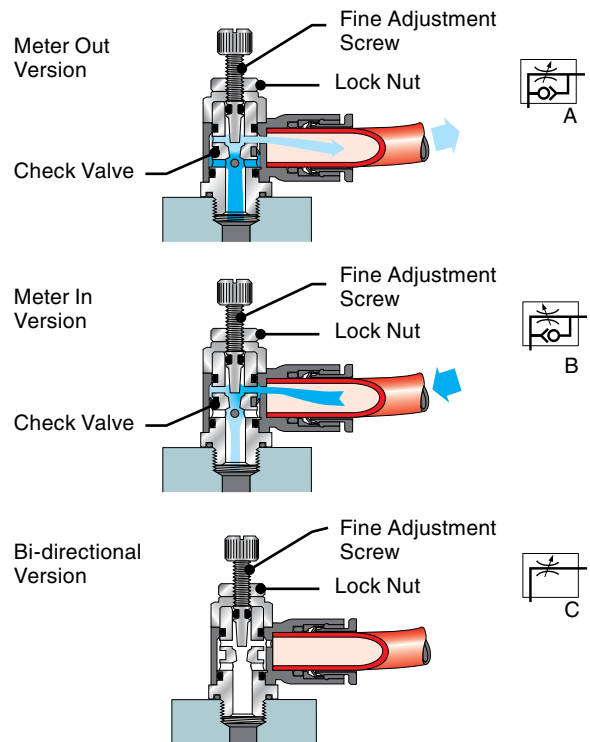

Assembly Instructions

1. Cut tubing squarely – maximum of 15° angle allowable.
2. Check that port or mating part is clean and free of debris.
3. Mark tubing to appropriate tube insertion length. (see Tube Insertion Chart on page N22)
4. Insert tubing until it bottoms
5. Pull on tubing to verify it is fully inserted
6. To disassemble, simply press release button, hold against body and pull tubing out of fitting.

WARNING These products can expose you to chemicals including NICKEL or LEAD, which are known to the state of California to cause cancer, and LEAD which is known to cause birth defects or other reproductive harm. For more information go to www.P65Warnings.ca.gov.



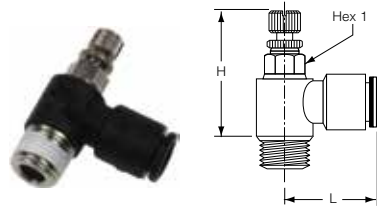

FCM731 Miniature Meter Out Flow Control

PART NO.	TUBE SIZE IN	NPT	HEX 1 MM	H OPEN	H CLOSED	L
FCM731-2-0	1/8	10-32	6	1.14	.91	.67
FCM731-2-2	1/8	1/8	7	1.41	1.26	.69
FCM731-5/32-0	5/32	10-32	6	1.02	.93	.67
FCM731-5/32-2	5/32	1/8	7	1.16	1.06	.71
FCM731-4-0	1/4	10-32	6	1.02	.93	.73
FCM731-4-2	1/4	1/8	7	1.16	1.06	.75
FCM731-4-4	1/4	1/4	8	1.28	1.18	.77

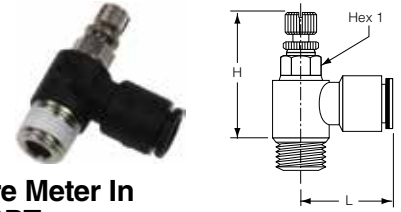

FCM731 Miniature Meter In Flow Control - BSPT

PART NO.	TUBE SIZE MM	BSPT	HEX 1	H CLOSED	H OPEN	L
FCM731-4M-2R	4	1/8	7	25.0	27.5	18.0
FCM731-6M-2R	6	1/8	7	25.0	27.5	18.5
FCM731-6M-4R	6	1/4	8	27.5	30.0	19.0
FCM731-8M-2R	8	1/8	13	28.5	33.0	26.0
FCM731-8M-4R	8	1/4	16	31.0	35.0	27.5
FCM731-8M-6R	8	3/8	20	36.0	42.0	29.0

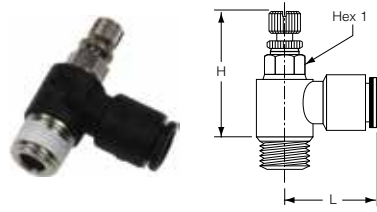

FCM731 Miniature Meter In Flow Control

PART NO.	TUBE SIZE IN	NPT	HEX 1 MM	H OPEN	H CLOSED	L
FCM731-2-0	1/8	10-32	6	1.14	.91	.67
FCM731-5/32-0	5/32	10-32	6	1.02	.93	.67
FCM731-5/32-2	5/32	1/8	7	1.16	1.06	.71
FCM731-4-0	1/4	10-32	6	1.02	.93	.73
FCM731-4-2	1/4	1/8	7	1.16	1.06	.75
FCM731-4-4	1/4	1/4	8	1.28	1.18	.77

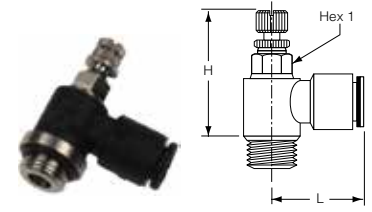

FCM731 Miniature Meter Out Flow Control - BSPP

PART NO.	TUBE SIZE MM	BSPP	HEX 1	H CLOSED	H OPEN	L
FCM731-3M-M3	3	M3X0.5	6	23.5	26.0	17.0
FCM731-3M-M5	3	M5X0.8	6	23.5	26.0	17.0
FCM731-4M-M3	4	M3X0.5	6	23.5	26.0	16.5
FCM731-4M-M5	4	M5X0.8	6	23.5	26.0	17.0
FCM731-4M-2G	4	1/8	7	27.0	29.5	18.0
FCM731-6M-M5	6	M5X0.8	6	23.5	26.0	18.0
FCM731-6M-2G	6	1/8	7	27.0	29.5	18.5
FCM731-6M-4G	6	1/4	8	30.0	32.5	19.0
FCM731-8M-2G	8	1/8	13	26.5	31.0	26.0
FCM731-8M-4G	8	1/4	16	29.0	34.0	27.5
FCM731-8M-6G	8	3/8	20	36.0	42.0	29.0

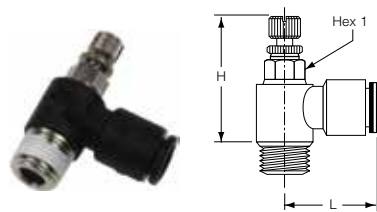

FCM731 Miniature Meter Out Flow Control - BSPT

PART NO.	TUBE SIZE MM	BSPT	HEX 1	H CLOSED	H OPEN	L
FCM731-4M-2R	4	1/8	7	25.0	27.5	18.0
FCM731-6M-2R	6	1/8	7	25.0	27.5	18.5
FCM731-6M-4R	6	1/4	8	27.5	30.0	19.0
FCM731-6M-6R	6	3/8	17	31.5	34.0	19.0
FCM731-8M-2R	8	1/8	13	28.5	33.0	26.0
FCM731-8M-4R	8	1/4	16	31.0	35.0	27.5
FCM731-8M-6R	8	3/8	20	36.0	42.0	29.0

WARNING These products can expose you to chemicals including NICKEL or LEAD, which are known to the state of California to cause cancer, and LEAD which is known to cause birth defects or other reproductive harm. For more information go to www.P65Warnings.ca.gov.

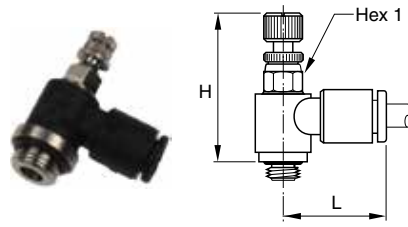

FCMI731 Miniature Meter In Flow Control - BSPP

PART NO.	TUBE SIZE MM	BSPP	HEX 1	H CLOSED	H OPEN	L
FCMI731-3M-M3	3	M3X0.5	6	23.5	26.0	17.0
FCMI731-3M-M5	3	M5X0.8	6	23.5	26.0	17.0
FCMI731-4M-M5	4	M5X0.8	6	23.5	26.0	17.0
FCMI731-4M-2G	4	1/8	7	27.0	29.5	18.0
FCMI731-6M-M5	6	M5X0.8	6	23.5	26.0	18.0
FCMI731-6M-2G	6	1/8	7	27.0	29.5	18.5
FCMI731-6M-4G	6	1/4	8	30.0	32.5	19.0
FCMI731-8M-2G	8	1/8	13	26.5	31.0	26.0
FCMI731-8M-4G	8	1/4	16	29.0	34.0	27.5
FCMI731-8M-6G	8	3/8	20	36.0	42.0	29.0

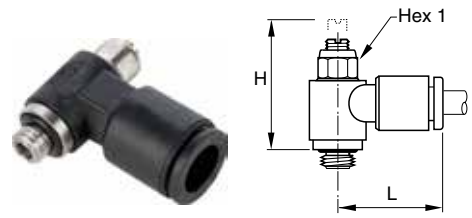

FCMK731 Knobless Mini Meter Out Flow Control

PART NO.	TUBE SIZE IN	NPT	HEX 1 MM	H OPEN	H CLOSED	L
FCMK731-2-0	1/8	10-32	6	.79	.65	.65
FCMK731-2-2	1/8	1/8	6	.85	.71	.71
FCMK731-5/32-0	5/32	10-32	6	.79	.65	.65
FCMK731-5/32-2	5/32	1/8	6	.85	.71	.71
FCMK731-4-0	1/4	10-32	6	.79	.65	.65
FCMK731-4-2	1/4	1/8	6	.85	.71	.73
FCMK731-4-4	1/4	1/4	6	.97	.83	.73

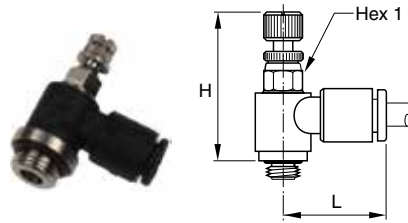

FCMB731 Miniature Bi-directional Flow Control - BSPP

PART NO.	TUBE SIZE MM	BSPP	HEX 1	H CLOSED	H OPEN	L
FCMB731-4M-M5	4	M5X0.8	6	23.5	26.0	16.5
FCMB731-4M-2G	4	1/8	7	27.0	29.5	17.0
FCMB731-6M-M5	6	M5X0.8	6	23.5	26.0	18.0
FCMB731-6M-2G	6	1/8	7	27.0	29.5	18.0
FCMB731-6M-4G	6	1/4	8	30.0	32.5	18.5

WARNING These products can expose you to chemicals including NICKEL or LEAD, which are known to the state of California to cause cancer, and LEAD which is known to cause birth defects or other reproductive harm. For more information go to www.P65Warnings.ca.gov.

Swivel Outlet Flow Controls



Parker's swivel outlet flow controls are designed to allow a vertical or angled tube exit where access is restricted.

Product Features:

- Glass reinforced nylon 6.6 body
- Stainless steel gripping ring
- Nickel-plated brass adjustment screw
- Nickel-plated brass locking nut
- Nickel-plated brass threads
- Nitrile D seal
- NPT, BSPT, BSPP, Metric threads

Markets:

- Factory/Process Automation
- Life Science
- Food Processing
- Water And Beverage
- Petrochemical

Applications:

- Packaging
- Filling
- Dispensing
- Bottling
- Pneumatic Circuits

Specifications:

Pressure Range 15 to 145 psi (1.0 to 9.9 bar)

Temperature Range +30° to +160° F (-1.1 to +71.1° C)

Compatible Tubing:

- Semi-rigid nylon
- Polyurethane 95 Durometer Shore A
- Nylon
- Fluoropolymer

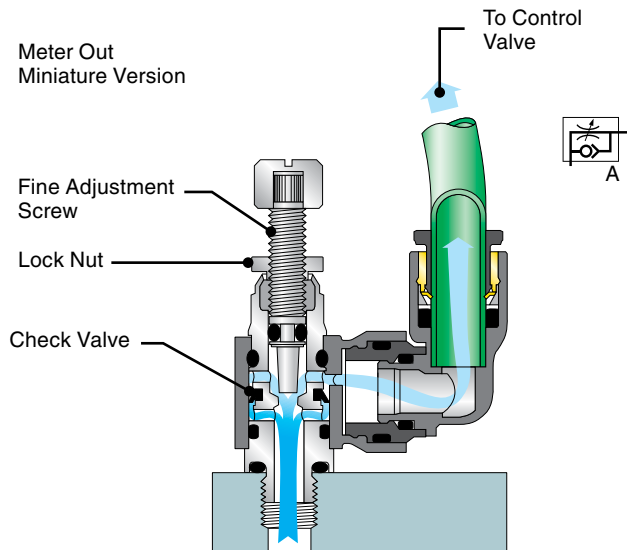

Assembly Instructions

1. Cut tubing squarely – maximum of 15° angle allowable.
2. Check that port or mating part is clean and free of debris.
3. Mark tubing to appropriate tube insertion length. (see Tube Insertion Chart on page N22)
4. Insert tubing until it bottoms
5. Pull on tubing to verify it is fully inserted
6. To disassemble, simply press release button, hold against body and pull tubing out of fitting.



WARNING These products can expose you to chemicals including NICKEL or LEAD, which are known to the state of California to cause cancer, and LEAD which is known to cause birth defects or other reproductive harm. For more information go to www.P65Warnings.ca.gov.



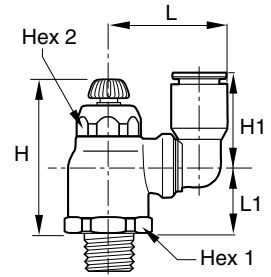

FCCS731 Compact Swivel Outlet Flow Control

PART NO.	TUBE SIZE IN	NPT	HEX 1 MM	HEX 2 MM	H CLOSED	H OPEN	H1	L	L1
FCCS731-4-2	1/4	1/8	19	10	1.87	2.09	.63	.93	.65
FCCS731-4-4	1/4	1/4	19	14	1.79	1.99	.73	1.00	.89
FCCS731-6-4	3/8	1/4	23	17	1.93	2.20	1.04	1.34	.97
FCCS731-6-6	3/8	3/8	23	17	1.93	2.20	1.04	1.34	.97

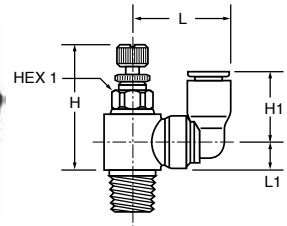

FCMS731 Mini Swivel Outlet Flow Control

PART NO.	TUBE SIZE IN	NPT	HEX 1 MM	H CLOSED	H OPEN	H1	L	L1
FCMS731-5/32-0	5/32	10-32	6	.96	1.08	.55	0.73	0.26
FCMS731-5/32-2	5/32	1/8	8	1.08	1.20	.55	0.73	0.33

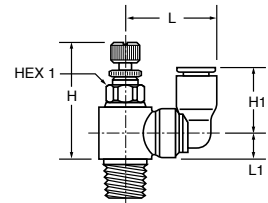

FCMS731 Miniature Swivel Outlet Flow Control - BSPT

PART NO.	TUBE SIZE MM	BSPT	HEX 1	H CLOSED	H OPEN	H1	L	L1
FCMS731-6M-2R	6	1/8	7	25	28.5	16.0	11.5	6.0

WARNING These products can expose you to chemicals including NICKEL or LEAD, which are known to the state of California to cause cancer, and LEAD which is known to cause birth defects or other reproductive harm. For more information go to www.P65Warnings.ca.gov.

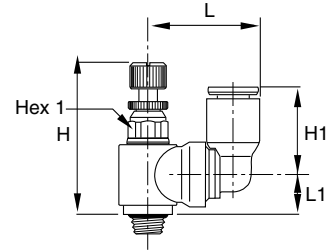

FCMS731 Miniature Swivel Outlet - BSPP

PART NO.	TUBE SIZE MM	BSPP	HEX 1	H CLOSED	H OPEN	H1	L	L1
FCMS731-4M-M5	4	M5X0.8	6	24.5	27.5	14.5	19.5	6.5
FCMS731-4M-2G	4	1/8	7	27.5	31.0	14.5	20.0	8.5
FCMS731-6M-M5	6	M5X0.8	6	24.5	27.5	16.0	21.5	6.5
FCMS731-6M-2G	6	1/8	7	27.5	31.0	16.0	22.0	8.5

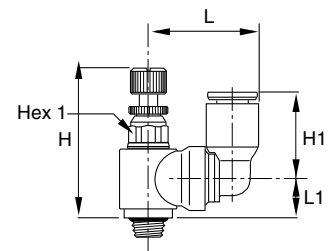

FCMSI731 Miniature Swivel Outlet Meter In - BSPP

PART NO.	TUBE SIZE MM	BSPP	HEX 1	H CLOSED	H OPEN	H1	L	L1
FCMSI731-4M-M5	4	M5X0.8	6	24.5	27.5	14.5	19.5	6.5
FCMSI731-4M-2G	4	1/8	7	27.5	31.0	14.5	20.0	8.5
FCMSI731-6M-M5	6	M5X0.8	6	24.5	27.5	16.0	21.5	6.5
FCMSI731-6M-2G	6	1/8	7	27.5	31.0	16.0	22.0	8.5

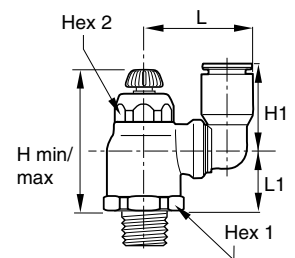

FCCS731 Compact Swivel Outlet - BSPP

PART NO.	TUBE SIZE MM	BSPP	HEX 1	HEX 2	H CLOSED	H OPEN	H1	L	L1
FCCS731-6M-2G	6	1/8	16	10	38.0	44.0	16.0	23.5	18.0
FCCS731-6M-4G	6	1/4	16	10	36.5	42.5	16.0	23.5	16.5
FCCS731-8M-2G	8	1/8	19	14	41.5	48.0	23.0	28.0	19.0
FCCS731-8M-4G	8	1/4	19	14	41.5	48.0	23.0	28.0	19.5
FCCS731-8M-6G	8	3/8	19	14	41.5	48.0	23.0	28.0	17.5
FCCS731-10M-4G	10	1/4	23	17	45.5	53.5	26.5	35.0	21.0
FCCS731-10M-6G	10	3/8	23	17	45.5	54.0	26.5	35.0	21.5
FCCS731-12M-6G	12	3/8	23	17	45.5	54.0	31.0	38.0	21.5
FCCS731-12M-8G	12	1/2	23	17	45.5	54.0	31.0	38.0	21.0

WARNING These products can expose you to chemicals including NICKEL or LEAD, which are known to the state of California to cause cancer, and LEAD which is known to cause birth defects or other reproductive harm. For more information go to www.P65Warnings.ca.gov.

Plug-In Flow Controls



Parker's Plug-in flow controls can be directly mounted into existing fittings and allow very compact installations. They are particularly suited for mounting in manifolds using cartridges.

Product Features:

- Glass reinforced nylon 6.6 body
- Stainless steel gripping ring
- Nickel-plated brass adjustment screw
- Nickel-plated brass locking nut
- Nickel-plated tailpiece
- Nitrile D seal

Markets:

- Factory/Process Automation
- Life Science
- Food Processing
- Water And Beverage
- Petrochemical

Applications:

- Packaging
- Filling
- Dispensing
- Bottling
- Pneumatic Circuits

Specifications:

Pressure Range 15 to 145 psi (1.0 to 9.9 bar)

Temperature Range +30° to +160° F (-1.1 to +71.1° C)

Compatible Tubing:

- Semi-rigid nylon
- Polyurethane 95 Durometer Shore A
- Nylon
- Fluoropolymer

Miniature

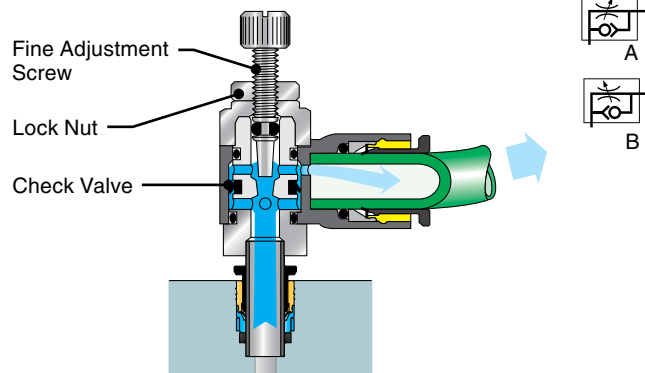

Compact

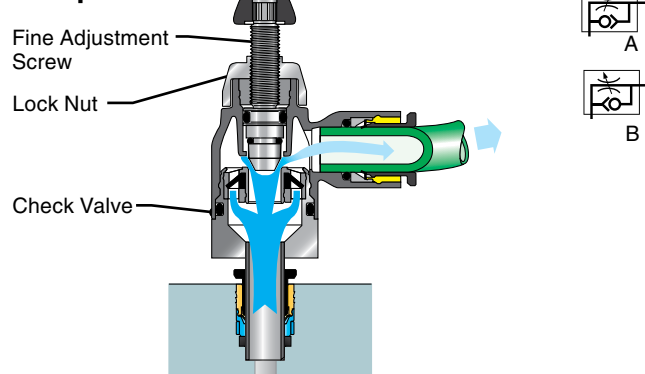

Assembly Instructions

1. Cut tubing squarely – maximum of 15° angle allowable.
2. Check that port or mating part is clean and free of debris.
3. Mark tubing to appropriate tube insertion length. (see Tube Insertion Chart on page N22)
4. Insert tubing until it bottoms
5. Pull on tubing to verify it is fully inserted
6. To disassemble, simply press release button, hold against body and pull tubing out of fitting.

WARNING These products can expose you to chemicals including NICKEL or LEAD, which are known to the state of California to cause cancer, and LEAD which is known to cause birth defects or other reproductive harm. For more information go to www.P65Warnings.ca.gov.



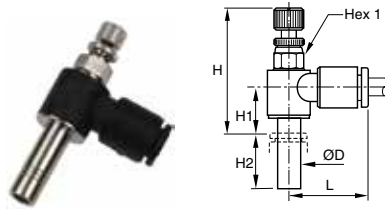

FCMS731 Plug-In Mini Meter Out Flow Control

PART NO.	TUBE SIZE IN	HEX 1 MM	H OPEN	H CLOSED	H1	H2	L
FCMS731-2	1/8	6	1.04	.94	.12	.59	0.67
FCMS731-4	1/4	7	1.18	1.08	.12	.73	0.73

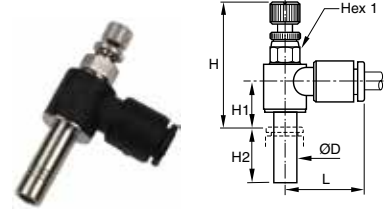

FCMSPI731 Plug-In Mini Meter In Flow Control

PART NO.	TUBE SIZE MM	HEX 1	H CLOSED	H OPEN	H1	H2	L
FCMSPI731-4M (5/32)	4	6	25.5	28.0	9.5	15.5	17.0
FCMSPI731-6M	6	7	27.5	29.0	10.5	17.0	18.5

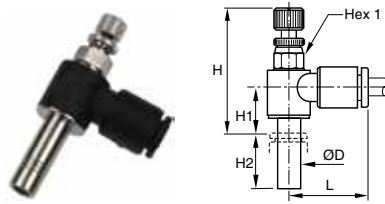

FCMSPI731 Plug-In Mini Meter In Flow Control

PART NO.	TUBE SIZE IN	HEX 1 MM	H OPEN	H CLOSED	H1	H2	L
FCMSPI731-2	1/8	6	1.04	.94	.12	0.59	0.67
FCMSPI731-4	1/4	7	1.18	1.08	.12	0.73	0.73

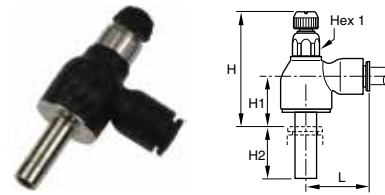

FCCSP731 Plug-In Compact Meter Out Flow Control

PART NO.	TUBE SIZE MM	HEX 1	H CLOSED	H OPEN	H1	H2	L
FCCSP731-6M	6	10	35.0	41.0	14.0	17.0	22.0
FCCSP731-8M	8	14	39.5	46.5	16.0	21.5	28.0
FCCSP731-12M	12	17	43.0	51.0	17.0	27.0	31.5

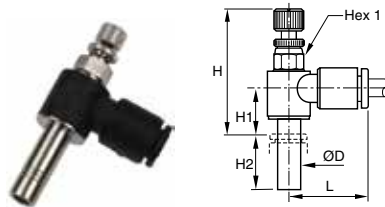

FCMS731 - Plug-In Miniature Meter Out Flow Control

PART NO.	TUBE SIZE MM	HEX 1	H CLOSED	H OPEN	H1	H2	L
FCMS731-4M (5/32)	4	6	25.5	28.0	9.5	15.5	17.0
FCMS731-6M	6	7	27.5	29.0	10.5	17.0	18.5

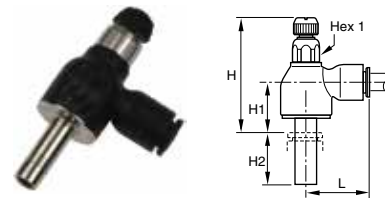

FCCSPI731 Plug-In Compact Meter-In Flow Control

PART NO.	TUBE SIZE MM	HEX 1	H CLOSED	H OPEN	H1	H2	L
FCCSPI731-6M	6	10	35.0	41.0	14.0	17.0	22.0
FCCSPI731-8M	8	14	39.5	46.5	16.0	21.5	28.0
FCCSPI731-12M	12	17	43.0	51.0	17.0	27.0	31.5

WARNING These products can expose you to chemicals including NICKEL or LEAD, which are known to the state of California to cause cancer, and LEAD which is known to cause birth defects or other reproductive harm. For more information go to www.P65Warnings.ca.gov.



In-Line Flow Controls



Parker's In-Line flow controls are unidirectional. An arrow on the body indicates the direction of controlled flow. They can be used individually or stacked together using joining clips.

Product Features:

- Glass reinforced nylon 6.6 body
- Stainless steel gripping ring
- Nickel-plated brass adjustment screw
- Nickel-plated brass locking nut
- Nickel-plated threads
- Nitrile D seal
- Panel mountable

Markets:

- Factory/Process Automation
- Life Science
- Food Processing
- Water And Beverage
- Petrochemical

Applications:

- Packaging
- Filling
- Dispensing
- Bottling
- Pneumatic Circuits

Specifications:

Pressure Range 15 to 145 psi (1.0 to 9.9 bar)

Temperature Range +30° to +160° F (-1.1 to +71.1° C)

Compatible Tubing:

- Semi-rigid nylon
- Polyurethane 95 Durometer Shore A
- Nylon
- Fluoropolymer

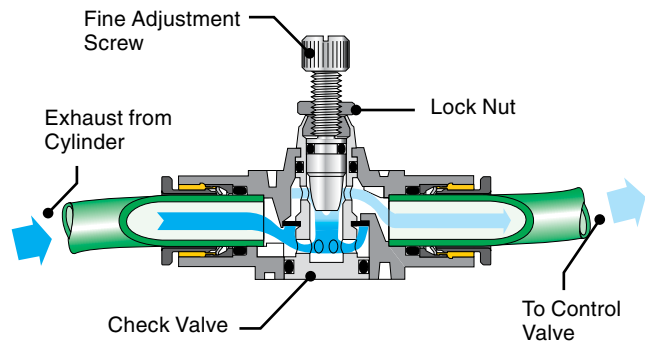

Assembly Instructions

1. Cut tubing squarely – maximum of 15° angle allowable.
2. Check that port or mating part is clean and free of debris.
3. Mark tubing to appropriate tube insertion length. (see Tube Insertion Chart on page N22)
4. Insert tubing until it bottoms
5. Pull on tubing to verify it is fully inserted
6. To disassemble, simply press release button, hold against body and pull tubing out of fitting.



WARNING These products can expose you to chemicals including NICKEL or LEAD, which are known to the state of California to cause cancer, and LEAD which is known to cause birth defects or other reproductive harm. For more information go to www.P65Warnings.ca.gov.



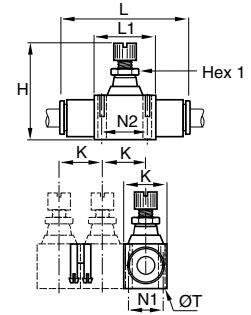

FC832 In-Line Flow Control

PART NO.	TUBE SIZE IN	HEX 1 MM	H CLOSED	H OPEN	K	L	L1	N1	N2	T
FC832-4	1/4	8	1.54	1.74	.66	2.00	.90	.43	.66	.12
FC832-6	3/8	14	2.03	2.38	.94	2.87	1.29	.62	1.01	1.60
FC832-8	1/2	14	2.24	2.63	1.09	3.35	1.37	.78	1.07	.16

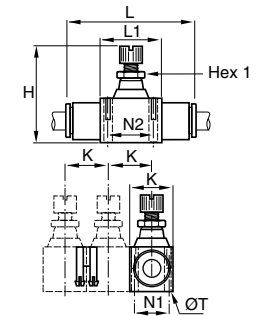

FCB832 In-Line Bi-directional Flow Control

PART NO.	TUBE SIZE IN	HEX 1 MM	H CLOSED	H OPEN	K	L	L1	N1	N2	T
FCB832-4	1/4	8	1.54	1.74	.66	2.00	.90	.43	.66	.12

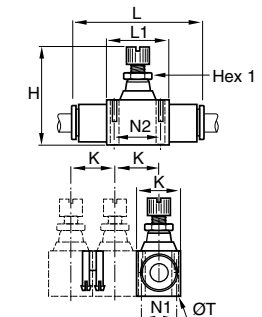

FC832 In-Line Flow Control

PART NO.	TUBE SIZE MM	HEX 1	H CLOSED	H OPEN	K	L	L1	N1	N2	T
FC832-6M	6	8	40.5	44.5	17.0	51.0	23.0	11.0	17.0	3.2
FC832-8M (5/16)	8	11	44.0	50.0	18.5	60.5	26.0	12.5	20.0	3.2
FC832-10M	10	14	52.0	61.0	24.0	76.0	33.0	16.0	26.0	4.2
FC832-12M	12	14	57.5	67.5	28.0	86.0	35.0	20.0	27.5	4.2

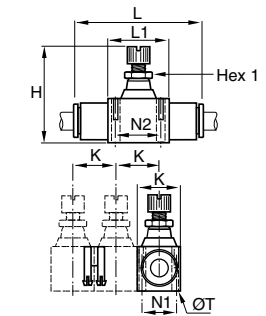

FCB832 In-Line Bi-directional Flow Control

PART NO.	TUBE SIZE MM	HEX 1	H CLOSED	H OPEN	K	L	L1	N1	N2	T
FCB832-4M (5/32)	4	5	29.5	33.5	12.0	36.0	15.0	8.0	11.0	2.2
FCB832-6M	6	8	40.0	44.5	17.0	51.0	23.0	11.0	17.0	3.2
FCB832-8M (5/16)	8	11	44.0	50.0	18.5	60.5	26.0	12.5	20.0	3.2

WARNING These products can expose you to chemicals including NICKEL or LEAD, which are known to the state of California to cause cancer, and LEAD which is known to cause birth defects or other reproductive harm. For more information go to www.P65Warnings.ca.gov.

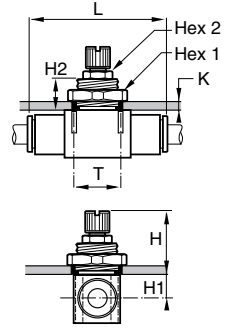

FCPM832 In-Line Panel Mountable Flow Control

PART NO.	TUBE SIZE MM	HEX 1	HEX 2	H CLOSED	H OPEN	K	L	H1	H2	T
FCPM832-4M	4	14		21.5	25.5	6.0	36.0	6.5	11.0	10.5
FCPM832-6M	6	19		27.5	32.5	7.0	51.0	7.5	13.5	16.5
FCPM832-8M	8	24	11	28.5	34.5	7.0	60.5	9.0	13.5	18.5
FCPM832-10M	10	30	14	29.5	38.5	7.0	76.0	11.5	13.5	24.5
FCPM832-12M	12	32	14	32.0	42.0	8.0	86.0	12.5	15.5	27.5

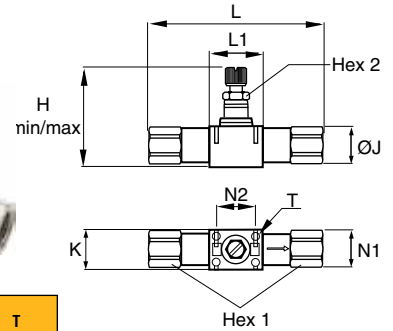

FC836 Threaded In-Line Flow Control

PART NO.	NPT	HEX 1 MM	HEX 2 MM	H CLOSED	H OPEN	K	L	L1	N1	N2	T
FC836-2	1/8	13	8.00	1.56	1.75	.67	2.70	.91	.43	.67	.12
FC836-4	1/4	16	11.00	1.73	1.97	.73	3.27	1.02	.49	.79	.12
FC836-6	3/8	22	14.00	2.05	2.40	.94	3.82	1.30	.63	1.02	.16
FC836-8	1/2	24	14.00	2.26	2.66	1.10	4.76	1.38	.79	1.08	.16

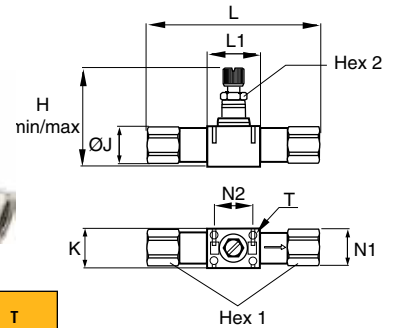

FC836 Threaded In-Line Flow Control - BSPP

PART NO.	BSPP	HEX 1	HEX 2	H CLOSED	H OPEN	K	L	N1	N2	T
FC836-2G	1/8	13	8	39.5	44.5	17.0	68.5	11.0	17.0	3.2
FC836-4G	1/4	16	11	44.0	50.0	18.5	83.0	12.5	20.0	3.2
FC836-6G	3/8	19	14	52.0	61.0	24.0	97.0	16.0	26.0	4.2
FC836-8G	1/2	24	14	57.5	67.5	28.0	121.0	20.0	27.5	4.2

WARNING These products can expose you to chemicals including NICKEL or LEAD, which are known to the state of California to cause cancer, and LEAD which is known to cause birth defects or other reproductive harm. For more information go to www.P65Warnings.ca.gov.

Metal Flow Controls

Parker's Metal flow controls are suited for use in severe conditions (temperatures, sparks, abrasion, etc.). Adjustment can be made with a screwdriver and locking by use of a wrench.

Product Features:

- Treated brass body
- Stainless steel gripping ring
- Electroless-nickel-plated brass adjustment screw
- Nickel-plated brass locking nut
- Nickel-plated threads
- Nitrile D seal

Markets:

- Factory/Process Automation
- Petrochemical
- Automotive Process

Applications:

- Robotics
- Packaging
- Textile

Specifications:

Pressure Range 15 to 145 psi (1.0 to 9.9 bar)

Temperature Range +30° to +160° F (-1.1 to +71.1° C)

Compatible Tubing:

- Semi-rigid nylon
- Polyurethane 95 Durometer Shore A
- Nylon
- Fluoropolymer



Meter Out Version

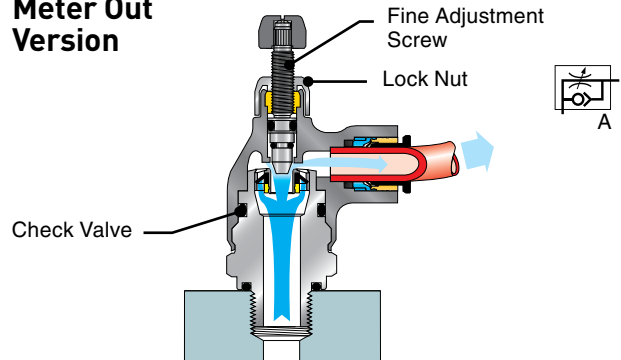

Meter In Version

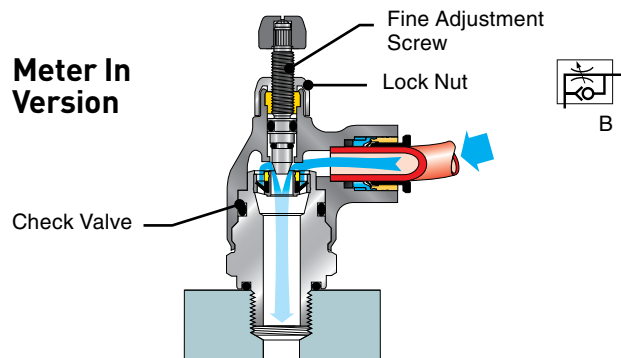

Assembly Instructions

1. Cut tubing squarely – maximum of 15° angle allowable.
2. Check that port or mating part is clean and free of debris.
3. Mark tubing to appropriate tube insertion length. (see Tube Insertion Chart on page N22)
4. Insert tubing until it bottoms
5. Pull on tubing to verify it is fully inserted
6. To disassemble, simply press release button, hold against body and pull tubing out of fitting.

WARNING These products can expose you to chemicals including NICKEL or LEAD, which are known to the state of California to cause cancer, and LEAD which is known to cause birth defects or other reproductive harm. For more information go to www.P65Warnings.ca.gov.



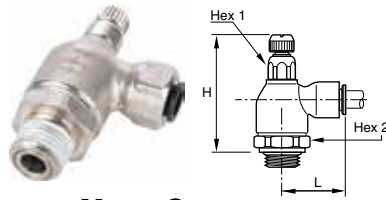

FC705 Push-to-Connect Meter Out Metal Flow Control

PART NO.	TUBE SIZE IN	NPT	HEX 1 MM	HEX 2 MM	H CLOSED	H OPEN	L
FC705-5/32-2	5/32	1/8	19	10	1.79	2.01	0.85
FC705-4-2	1/4	1/8	19	10	1.79	2.01	0.97
FC705-4-4	1/4	1/4	19	10	1.79	2.01	0.97
FC705-6-4	3/8	1/4	19	14	1.91	2.11	1.14
FC705-6-6	3/8	3/8	25	17	2.15	2.40	1.40

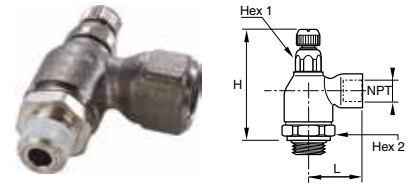

FC708 Threaded Port Meter Out Flow Control

PART NO.	NPT	HEX 1 MM	HEX 2 MM	H CLOSED	H OPEN	L
FC708-2	1/8	19	10	1.79	2.01	.89
FC708-4	1/4	19	14	1.91	2.11	1.28
FC708-6	3/8	25	17	2.15	2.40	1.36
FC708-8	1/2	25	17	2.15	2.40	1.50

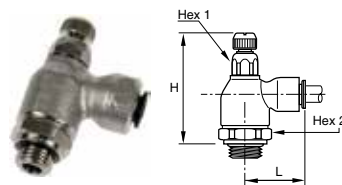

FC701 Push-to-Connect Meter Out Metal Flow Control - BSPP

PART NO.	TUBE SIZE MM	BSPP	HEX 1	HEX 2	H CLOSED	H OPEN	L
FC701-4M-2G	4	1/8	10	19	47.0	53.0	21.0
FC701-6M-2G	6	1/8	10	19	47.0	53.0	24.5
FC701-6M-4G	6	1/4	10	19	47.5	53.0	24.5
FC701-8M-2G	8	1/8	14	19	50.0	55.0	29.0
FC701-8M-4G	8	1/4	14	19	50.0	56.0	29.0
FC701-8M-6G	8	3/8	17	25	56.0	62.0	30.5
FC701-10M-4G	10	1/4	14	19	50.0	56.0	35.0
FC701-10M-6G	10	3/8	17	25	56.0	62.0	35.0
FC701-12M-6G	12	3/8	17	25	56.0	62.0	38.0
FC701-12M-8G	12	1/2	17	25	55.0	62.0	38.0
FC701-14M-8G	14	1/2	17	25	55.0	62.0	41.0

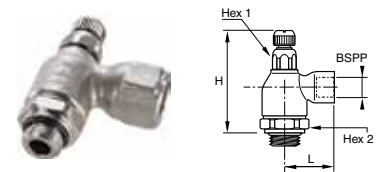

FC702 Threaded Port Meter Out Metal Flow Control - BSPP

PART NO.	BSPP	HEX 1	HEX 2	H CLOSED	H OPEN	L
FC702-2G	1/8	10	19	47.0	52.5	22.5
FC702-4G	1/4	14	19	50.5	55.5	32.0
FC702-6G	3/8	17	25	56.0	62.0	34.5
FC702-8G	1/2	17	25	55.0	62.0	37.5

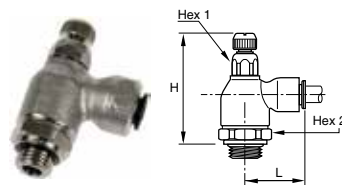

FCI701 Push-to-Connect Meter In Metal Flow Control - BSPP

PART NO.	TUBE SIZE MM	BSPP	HEX 1	HEX 2	H CLOSED	H OPEN	L
FCI701-4M-2G	4	1/8	10	19	47.0	53.0	21.0
FCI701-6M-2G	6	1/8	10	19	47.0	53.0	24.5
FCI701-6M-4G	6	1/4	10	19	47.5	53.0	24.5
FCI701-8M-2G	8	1/8	14	19	50.0	55.0	29.0
FCI701-8M-4G	8	1/4	14	19	50.0	56.0	29.0
FCI701-8M-6G	8	3/8	17	25	56.0	62.0	30.5

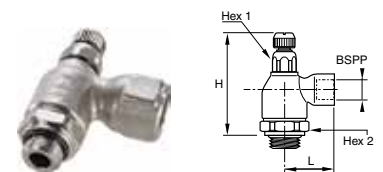

FCI702 Threaded Port Meter In Metal Flow Control - BSPP

PART NO.	BSPP	HEX 1	HEX 2	H CLOSED	H OPEN	L
FCI702-2G	1/8	10	19	47.0	52.5	22.5
FCI702-4G	1/4	14	19	50.5	55.5	32.0

WARNING These products can expose you to chemicals including NICKEL or LEAD, which are known to the state of California to cause cancer, and LEAD which is known to cause birth defects or other reproductive harm. For more information go to www.P65Warnings.ca.gov.

Stainless Steel Flow Controls



Parker's Stainless Steel Flow Controls are used to regulate the speed of a cylinder rod as well as flow in environments with high mechanical or chemical constraints.

Product Features:

- Suitable for corrosive environments
- Excellent mechanical and chemical resistance
- 100% leak tested in production
- Smooth external surfaces to facilitate cleaning
- Suitable for food applications

Markets:

- Factory/Process Automation
- Life Science
- Food Processing
- Water And Beverage
- Petrochemical

Applications:

- Packaging
- Filling
- Dispensing
- Bottling,
- Pneumatic Circuits
- Semi-Conductors

Specifications:

Pressure Range 15 to 145 psi (1.0 to 9.9 bar)

Temperature Range +30° to +160° F (-1.1 to +71.1° C)

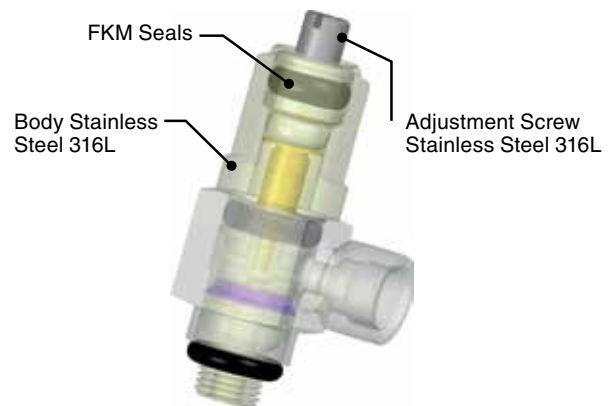

Assembly Instructions

1. Cut tubing squarely – maximum of 15° angle allowable.
2. Check that port or mating part is clean and free of debris.
3. Mark tubing to appropriate tube insertion length. (see Tube Insertion Chart on page N22)
4. Insert tubing until it bottoms
5. Pull on tubing to verify it is fully inserted
6. To disassemble, simply press release button, hold against body and pull tubing out of fitting.

Operation

Exhaust Model with External Adjustment

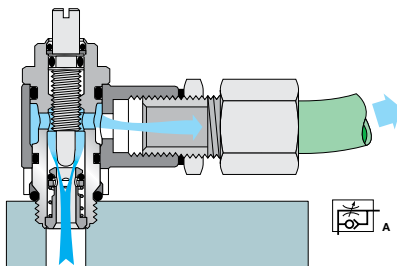

Bi-Directional Model with External Adjustment

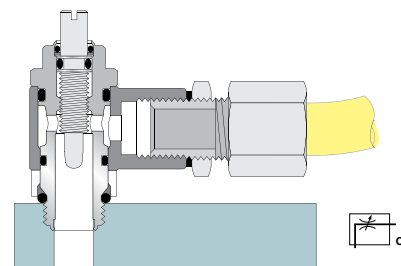

WARNING These products can expose you to chemicals including NICKEL or LEAD, which are known to the state of California to cause cancer, and LEAD which is known to cause birth defects or other reproductive harm. For more information go to www.P65Warnings.ca.gov.



7810, 7812, 7815, 7817 Threaded Port Knobless Stainless Steel Flow Control - NPT, UNF

PART NO. METER OUT	PART NO. BI-DIRECTIONAL	C	E	E1	F	H	J	L	WT. OZ.
7810 20 20	7812 20 20	10-32	.16	.16	8	.94	.35	.43	.95
7815 11 11	7817 11 11	1/8	.20	.31	13	1.50	.59	.67	1.23
7815 14 14	7817 14 14	1/4	.31	.47	17	1.38	.71	.94	1.69
7815 18 18	7817 18 18	3/8	.28	.55	20	1.89	.87	1.06	2.08
7815 22 22	7817 22 22	1/2	.31	.59	23	2.52	1.10	1.22	2.68

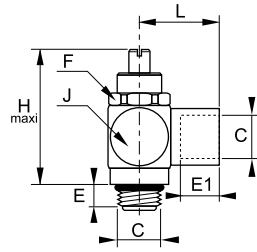

7810, 7812, Threaded Port Knobless Stainless Steel Flow Control - BSPP Metric

PART NO. METER OUT	PART NO. BI-DIRECTIONAL	C	E	E1	F	H	J	L	WT. KG.
7810 19 19	7812 19 19	M5X0.8	4	4	8	24	10	11	.027
7810 10 10	7812 10 10	G1/8	5	8	13	38	15	17	.035
7810 13 13	7812 13 13	G1/4	8	12	17	40	18	24	.048
7810 17 17	7812 17 17	G3/8	7	12	20	53	22	24	.059
7810 21 21	7812 21 21	G1/2	8	15	23	69	28	31	.076

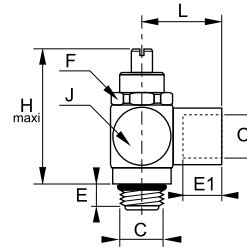

7835 Push-to-Connect Knobless Stainless Steel Flow Control Tube to NPT

PART NO. METER OUT	ØD	C	F MM	H	J	L	WT. OZ.
7835 04 11	5/32	1/8	13	1.30	.59	.79	1.23
7835 04 14	5/32	1/4	17	1.38	.71	.87	1.54
7835 56 11	1/4	1/8	13	1.30	.59	.87	1.69
7835 56 14	1/4	1/4	17	1.38	.71	.95	1.82
7835 60 14	3/8	1/4	17	1.38	.71	1.18	2.08
7835 60 18	3/8	3/8	20	1.89	.87	1.26	2.68

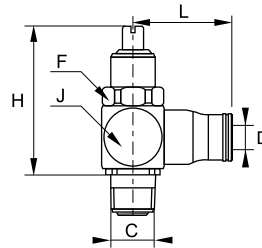

WARNING These products can expose you to chemicals including NICKEL or LEAD, which are known to the state of California to cause cancer, and LEAD which is known to cause birth defects or other reproductive harm. For more information go to www.P65Warnings.ca.gov.

In-Line Check Valves



Parker's In-Line Check Valves allows air to pass in one direction while blocking flow in the other direction. The body of the fitting contains an arrow to indicate the direction of flow.

Product Features:

- Nylon/Nickel-plated brass body
- VC – Acetal body
- Stainless steel gripping ring
- Nickel-plated brass threads
- Nitrile O-ring
- EPDM O-ring (VC)

Markets:

- Factory/Process Automation
- Packaging
- Petrochemical
- Pneumatics
- Semi-Conductor

Applications:

- Robotics
- Packaging
- Textile
- Machine Tools
- Pneumatic Systems
- Vacuum

Specifications:

Pressure Range 15 to 145 psi (1.0 to 9.9 bar)

Temperature Range +34° to +150° F (+1.1° to 65.5° C)

Cracking Pressure PLCK – 7 PSI (0.4 bar),
VC – 1/3 PSI (0.02 bar)

Compatible Tubing:

- Semi-rigid nylon
- Polyurethane 95 Durometer Shore A
- Nylon
- Fluoropolymer

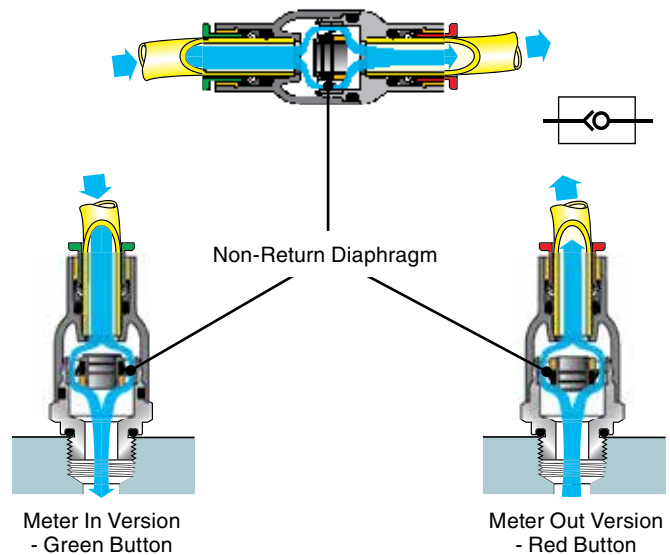

Assembly Instructions

1. Cut tubing squarely – maximum of 15° angle allowable.
2. Check that port or mating part is clean and free of debris.
3. Mark tubing to appropriate tube insertion length. (see Tube Insertion Chart on page N22)
4. Insert tubing until it bottoms
5. Pull on tubing to verify it is fully inserted
6. To disassemble, simply press release button, hold against body and pull tubing out of fitting.



WARNING These products can expose you to chemicals including NICKEL or LEAD, which are known to the state of California to cause cancer, and LEAD which is known to cause birth defects or other reproductive harm. For more information go to www.P65Warnings.ca.gov.



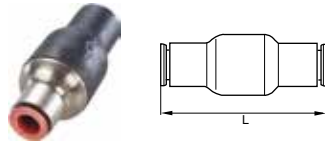

32PLCK In-Line Check Valve

PART NO.	TUBE SIZE IN	L
32PLCK-4	1/4	1.61
32PLCK-6	3/8	2.50

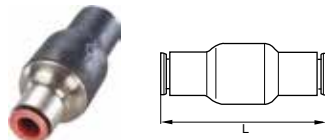

32PLCK In-Line Check Valve

PART NO.	TUBE SIZE MM	L
32PLCK-4M (5/32)	4	38.5
32PLCK-6M	6	41.0
32PLCK-8M (5/16)	8	51.5
32PLCK-10M	10	63.5
32PLCK-12M	12	66.5

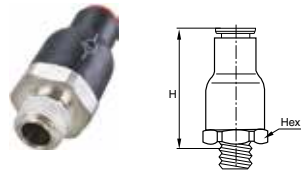

W68PLCK Male Check Valve

PART NO.	TUBE SIZE IN	NPT / UNF	HEX MM	H
W68PLCK-4M-2	5/32	1/8	16	1.12
W68PLCK-4-2	1/4	1/8	19	1.42
W68PLCK-4-4	1/4	1/4	19	1.42
W68PLCK-6-4	3/8	1/4	23	1.65
W68PLCK-6-6	3/8	3/8	23	1.65

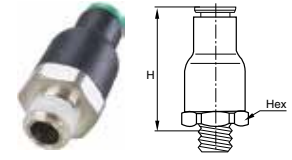

W68PLCKI Male Check Valve Meter In

PART NO.	TUBE SIZE IN	NPT / UNF	HEX MM	H
68PLCKI-4M-0	5/32	10-32	9	1.26
W68PLCKI-4M-2	5/32	1/8	16	1.12
W68PLCKI-4-2	1/4	1/8	19	1.42
W68PLCKI-4-4	1/4	1/4	19	1.42
W68PLCKI-6-4	3/8	1/4	23	1.65
W68PLCKI-6-6	3/8	3/8	23	1.65

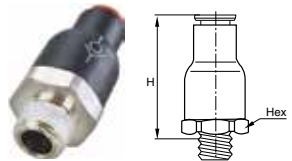

W68PLCK Male Check Valve Meter Out - BSPT

PART NO.	TUBE SIZE MM	BSPT	HEX 1	H
W68PLCK-4M-2R	4	1/8	16	28.5
W68PLCK -6M-2R	6	1/8	16	30.5
W68PLCK -6M-4R	6	1/4	16	30.5
W68PLCK -8M-2R	8	1/8	19	36.0
W68PLCK -8M-4R	8	1/4	19	36.0
W68PLCK -10M-6R	10	3/8	23	42.0
W68PLCK -12M-6R	12	3/8	23	42.0

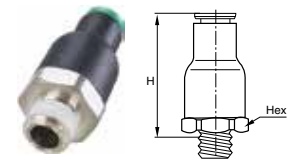

W68PLCKI Male Check Valve Meter In - BSPT

PART NO.	TUBE SIZE MM	BSPT	HEX 1	H
W68PLCKI-4M-2R	4	1/8	16	28.5
W68PLCKI -6M-2R	6	1/8	16	30.5
W68PLCKI -6M-4R	6	1/4	16	30.5
W68PLCKI -8M-2R	8	1/8	19	36.0
W68PLCKI -8M-4R	8	1/4	19	36.0

WARNING These products can expose you to chemicals including NICKEL or LEAD, which are known to the state of California to cause cancer, and LEAD which is known to cause birth defects or other reproductive harm. For more information go to www.P65Warnings.ca.gov.

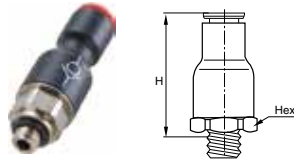

68PLCK Male Check Valve Meter Out - BSPP

PART NO.	TUBE SIZE MM	BSPP	HEX 1	H
68PLCK-4M-M5	4	M5X0.8	9	32.0
68PLCK-6M-2G	6	1/8	16	30.5
68PLCK-6M-4G	6	1/4	16	30.5
68PLCK-8M-2G	8	1/8	19	36.0
68PLCK-8M-4G	8	1/4	19	36.0

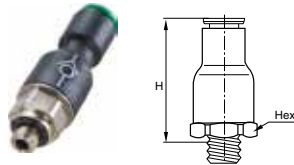

68PLCKI Male Check Valve Meter In - BSPP

PART NO.	TUBE SIZE MM	BSPP	HEX 1	H
68PLCKI-6M-2G	6	1/8	16	30.5
68PLCKI-8M-2G	8	1/8	19	36.0
68PLCKI-8M-4G	8	1/4	19	36.0
68PLCKI-12M-6G	12	3/8	23	42.0
68PLCKI-12M-8G	12	1/2	23	44.0

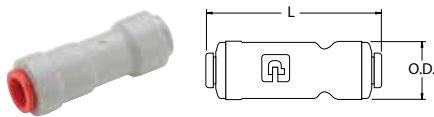

VC – Check Valve

PART NO.	TUBE SIZE IN	L	O.D.
A4VC4-MG	1/4	2.00	.66
A5VC5-MG	5/16	2.10	.70
A6VC6-MG	3/8	2.15	.80

WARNING These products can expose you to chemicals including NICKEL or LEAD, which are known to the state of California to cause cancer, and LEAD which is known to cause birth defects or other reproductive harm. For more information go to www.P65Warnings.ca.gov.



Stainless Steel Check Valves

Parker's Stainless Steel Check Valves are ideally suited to harsh environments and for conveying industrial fluids. These check valves allow fluids to flow in one direction and prevent them from flowing in the other.

Product Features:

- 316L Stainless Steel Body & Poppet
- 302 Stainless Steel Spring
- FKM Seals
- Smooth external surfaces contribute to equipment cleanliness
- Suitable for use in corrosive environments

Markets:

- Factory/Process Automation
- Life Science
- Food Processing
- Water And Beverage
- Petrochemical

Applications:

- Pneumatics
- Machine Tools
- Processing
- Chemical
- Printing

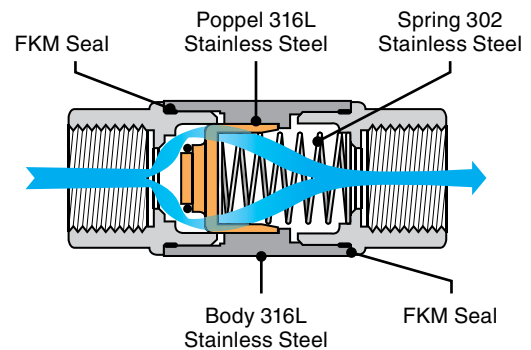

Specifications:

Pressure Range 7 to 580 PSI (0.4 to 39.9 bar)

Cracking Pressure 3.6 PSI (0.2 bar)

Temperature Range -4° to +356° F (-20° to +180° C)

Flow Characteristics

MODEL	WATER FLOW AT 90 PSI	KV
1/8	.67 SCFM	1.60
1/4	.70 SCFM	1.69
3/8	1.26 SCFM	3.01
1/2	1.29 SCFM	3.10
3/4	2.33 SCFM	5.59
1	3.27 SCFM	7.86



WARNING These products can expose you to chemicals including NICKEL or LEAD, which are known to the state of California to cause cancer, and LEAD which is known to cause birth defects or other reproductive harm. For more information go to www.P65Warnings.ca.gov.



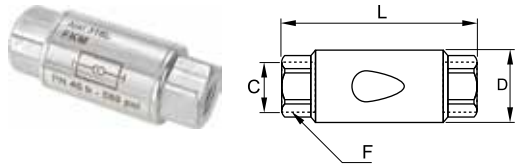

4890 Unidirectional Female - BSPP

PART NO.	C	DN	D MM	F MM	L MM	WT. KG.
4890 10 10	G1/8	10	22	17	50	.084
4890 13 13	G1/4	10	22	17	50	.074
4890 17 17	G3/8	15	30	22	67	.182
4890 21 21	G1/2	15	30	25	71	.196
4890 27 27	G3/4	20	42	32	84	.288
4890 34 34	G1	25	42	38	90	.416

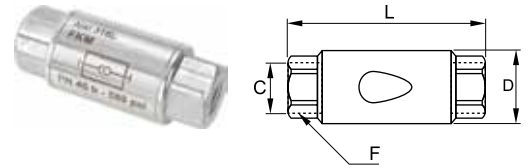

4895 Unidirectional Female - NPT

PART NO.	C	DN	D MM	F MM	L MM	WT. KG.
4895 11 11	1/8	10	22	18	50	.084
4895 14 14	1/4	10	22	18	54	.080
4895 18 18	3/8	15	30	22	73	.198
4895 22 22	1/2	15	30	25	77	.213

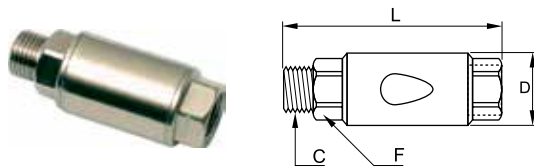

4891 Unidirectional Male to Female - BSPP

PART NO.	C	DN	D MM	F MM	L MM	WT. KG.
4891 10 10	G1/8	10	22	17	56	.086
4891 13 13	G1/4	10	22	17	58	.082
4891 17 17	G3/8	15	30	22	75	.190
4891 21 21	G1/2	15	30	25	79	.280
4891 27 27	G3/4	20	42	32	98	.302
4891 34 34	G1	25	42	38	104	.424

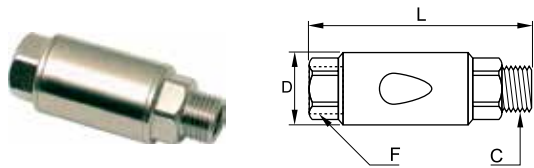

4892 Unidirectional Female to Male - BSPP

PART NO.	C	DN	D MM	F MM	L MM	WT. KG.
4892 10 10	G1/8	10	22	17	56	.086
4892 13 13	G1/4	10	22	17	58	.082
4892 17 17	G3/8	15	30	22	75	.190
4892 21 21	G1/2	15	30	25	79	.280
4892 27 27	G3/4	20	42	32	98	.302
4892 34 34	G1	25	42	38	104	.424

WARNING These products can expose you to chemicals including NICKEL or LEAD, which are known to the state of California to cause cancer, and LEAD which is known to cause birth defects or other reproductive harm. For more information go to www.P65Warnings.ca.gov.



Pilot Operated Check Valves

Parker's Pilot Operated Check Valves are designed to protect installations. If the compressed air supply is removed they lock the air supply to the cylinder, maintaining it in position.

Product Features:

- Orientable and adjustable through 3 axis
- Can be integrated into any installation configuration
- Vent saves time on restart after maintenance operations
- Multi-purpose fitting
 - Piloted non-return valve
 - Flow control regulator
 - Manual exhaust

Markets:

- Factory/Process Automation
- Food Processing
- Pneumatics
- Automotive

Applications:

- Pneumatics
- Machine Tools
- Processing
- Packaging
- Assembly

Specifications:

Pressure Range 14 to 145 PSI (0.9 to 9.9 bar)

Cracking Pressure 4.3 PSI (0.2 bar)

Temperature Range +23° to +140° F (-5° to 60° C)

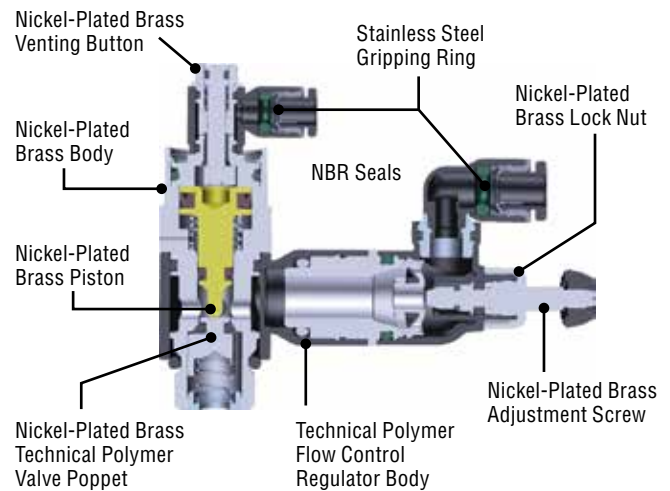

Assembly Instructions

1. Cut tubing squarely – maximum of 15° angle allowable.
2. Check that port or mating part is clean and free of debris.
3. Mark tubing to appropriate tube insertion length. (see Tube Insertion Chart on page N22)
4. Insert tubing until it bottoms
5. Pull on tubing to verify it is fully inserted
6. To disassemble, simply press release button, hold against body and pull tubing out of fitting.



WARNING These products can expose you to chemicals including NICKEL or LEAD, which are known to the state of California to cause cancer, and LEAD which is known to cause birth defects or other reproductive harm. For more information go to www.P65Warnings.ca.gov.



Operation

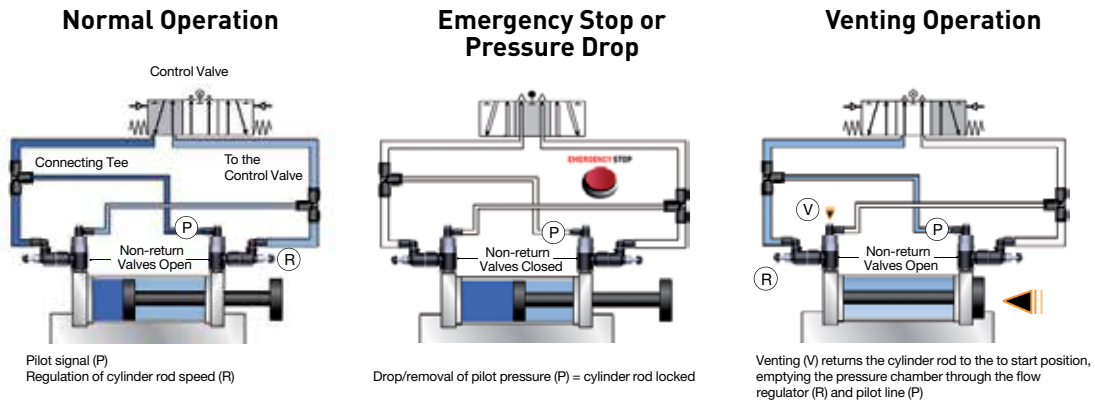

7892 Piloted Non-Return Valve - BSPP

PART NO.	D MM	C	E MM	F MM	G MM	H MM	H1 MM	H2 MM	L MM	WT. KG.
7892 06 10	6	G1/8	6	13	14	42	30	7	21	.028
7892 06 13	6	G1/4	9	17	18.5	45	32	9	23	.049
7892 08 10	8	G1/8	6	13	14	42	29	9	25	.029
7892 08 13	8	G1/4	9	17	18.5	45	32	9	27	.051
7892 08 17	8	G3/8	6	20	22.5	57	41	11	28	.093
7892 10 17	10	G3/8	6	20	22.5	57	41	11	31	.094
7892 10 21	10	G1/2	10	24	28	63	47	16	36	.172
7892 12 21	12	G1/2	10	24	28	63	47	16	36	.162

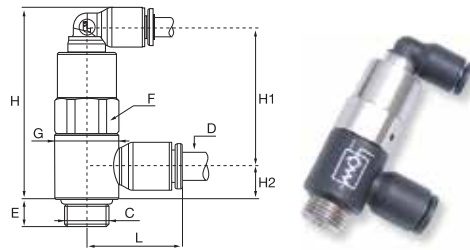

7894 Piloted Non-Return Valve with Flow Regulator and Exhaust - BSPP

PART NO.	D MM	C	E MM	F1 MM	F2 MM	G MM	H MM	H1 MM	H2 MM	H3 MM	L MIN	L MAX	L MM	WT. KG.
7894 06 10	6	G1/8	6	13	8	14	46	7	24	31	48.5	51	16	.049
7894 06 13	6	G1/4	9	17	10	18.5	49	11	18	31	59.5	65	17	.081
7894 08 10	8	G1/8	6	13	8	14	46	7	27	31	48.5	51	22	.050
7894 08 13	8	G1/4	9	17	10	18.5	49	11	23	31	59.5	65	23	.084
7894 08 17	8	G3/8	6	20	14	22.5	69	13	21	40	67.5	73	23	.148
7894 10 17	10	G3/8	6	20	14	22.5	69	13	29	40	67.5	73	26	.152
7894 10 21	10	G1/2	10	24	17	28	76	12.5	26	47	74	81	26	.234
7894 12 21	12	G1/2	10	24	17	28	76	12.5	27	47	74	81	30	.236

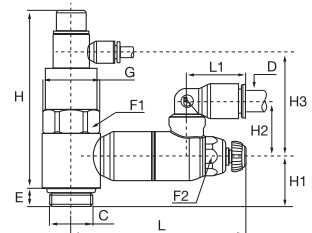

WARNING These products can expose you to chemicals including NICKEL or LEAD, which are known to the state of California to cause cancer, and LEAD which is known to cause birth defects or other reproductive harm. For more information go to www.P65Warnings.ca.gov.



Pneumatic Slide Valves

Parker's Slide Valves may be used to effect an immediate isolation of the air line by venting the system to atmosphere. By moving the sleeve in one direction, the air is free to pass through the slide valve to the system. By moving it in the opposite direction, the supply is shut off and the downstream air is allowed to exhaust to the atmosphere.

Product Features:

- Lightweight due to use of aluminum
- Nitrile Seals
- Immediate identification of the venting system by the color (red)
- Uni-directional use ensures the downstream circuit is vented
- Operated in the plane of the tube

Markets:

- Factory/Process Automation
- Food Processing
- Packaging

Applications:

- Pneumatics
- Conveyors
- Packaging
- Textile
- Plastics Engineering

Specifications:

Pressure Range Up to 230 PSI (15.8 bar)

Temperature Range +15° to +175° F (-9.4° to +79.4° C)

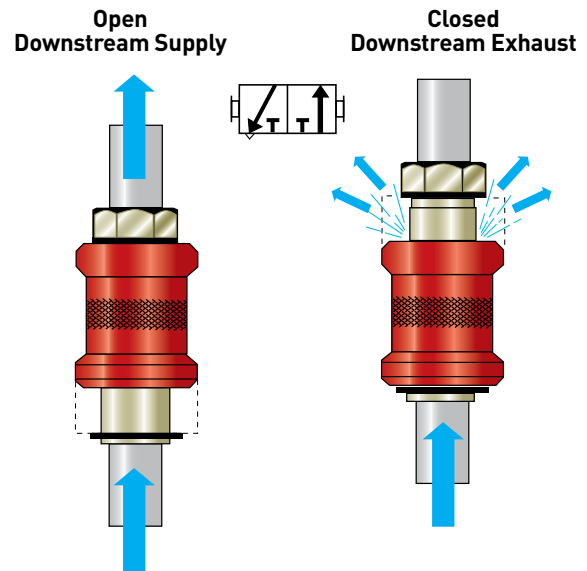

WARNING These products can expose you to chemicals including NICKEL or LEAD, which are known to the state of California to cause cancer, and LEAD which is known to cause birth defects or other reproductive harm. For more information go to www.P65Warnings.ca.gov.

0660 Female Slide Valve - NPT

PART NO.	C	DN	F	G	L	WT. OZ.
0660 04 11	1/8	.16	.55	.98	1.89	2.12
0660 07 14	1/4	.27	.67	1.18	2.28	3.71
0660 10 18	3/8	.39	.87	1.38	2.68	6.18
0660 14 22	1/2	.55	1.06	1.57	3.15	9.53

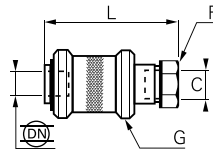

0661 Male to Female Slide Valve - NPT

PART NO.	C	DN	F	G	L	WT. OZ.
0661 04 11	1/8	.16	.55	.98	2.19	2.47
0661 07 14	1/4	.27	.67	1.18	2.75	4.59
0661 10 18	3/8	.39	.87	1.38	3.21	7.59
0661 14 22	1/2	.55	1.06	1.57	3.75	11.30

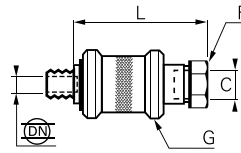

0669 Female Slide Valve - BSPP

PART NO.	C	DN	F MM	G MM	L MM	WT. KG.
0669 02 19	M5X0.8	2	10	14	30.5	.045
0669 04 10	G1/8	4	14	25	48	.051
0669 07 13	G1/4	7	19	30	58	.084
0669 10 17	G3/8	10	22	35	68	.153
0669 14 21	G1/2	14	27	40	80	.227
0669 19 27	G3/4	19	32	50	83	.242

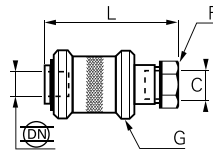

WARNING These products can expose you to chemicals including NICKEL or LEAD, which are known to the state of California to cause cancer, and LEAD which is known to cause birth defects or other reproductive harm. For more information go to www.P65Warnings.ca.gov.

Quick Exhaust Valve



Parker's Quick Exhaust Valve increases the return speed of the cylinder rod by allowing the exhaust to pass directly to atmosphere.

Product Features:

- Nickel plated brass body
- Nylon seal
- Polyurethane piston
- Reduction in cycle times: return speed improved
- Excellent exhaust capacity
- Ideal for applications in restrictive environments

Markets:

- Factory/Process Automation
- Packaging
- Industrial
- Pulp & Paper

Applications:

- Pneumatics
- Conveyors
- Packaging
- Textile
- Plastics Engineering

Specifications:

Pressure Range 10 to 150 PSI (0.6 to 10.3 bar)

Temperature Range 0° to +160° F (-17.7 to +71.1° C)

7970 Quick Exhaust Valve Threaded Ports - BSPP

PART NO.	C	F	H	H1	L	WT.OZ.
7970 19 19	M5 x 0.8	10	24.8	15.6	4	.029
7970 10 10	G1/8	14	42	28	8	.084
7970 13 13	G1/4	19	53	34.5	11	.148
7970 17 17	G3/8	21	58	36	12	.153
7970 21 21	G1/2	26	71	44	14	.316
7970 27 27	G3/4	32	86	52	18	.449
7970 34 34	G1	38	94	56	19	.531

7982 Quick Exhaust Valve Threaded Ports - NPT

PART NO.	C	F	H	H1	L	WT. OZ.
7982 11 11	1/8	14	1.69	1.10	.28	2.97
7982 14 14	1/4	19	2.11	1.38	.37	5.18
7982 18 18	3/8	20	2.19	1.42	.35	5.64
7982 22 22	1/2	26	2.83	1.77	.55	11.29

Operation

Mounted on Cylinder

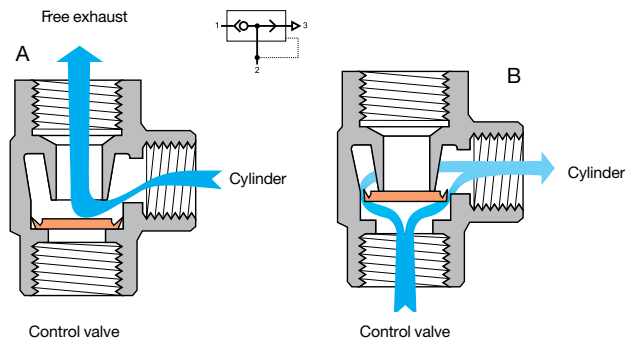

Installation Diagram

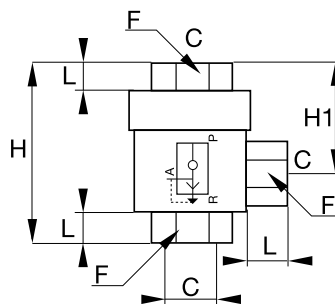
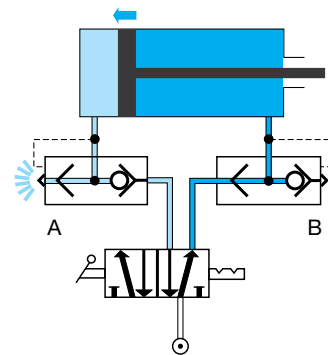

WARNING These products can expose you to chemicals including NICKEL or LEAD, which are known to the state of California to cause cancer, and LEAD which is known to cause birth defects or other reproductive harm. For more information go to www.P65Warnings.ca.gov.



Blocking Valves



Parker's Blocking Valves prevents damage to work and equipment in the event of a loss of pressure. Blocking valves which are mounted in pairs on a cylinder lock the piston by simultaneously cutting off the supply and exhaust.

Product Features:

- Treated brass body
- Stainless steel gripping ring
- Nickel-plated brass threads
- NBR seals
- Silicone free

Markets:

- Factory/Process Automation
- Packaging
- Petrochemical
- Automotive Process

Applications:

- Robotics
- Packaging
- Textile
- Machine Tools

Compatible Tubing:

- Semi-rigid nylon
- Polyurethane 95 Durometer Shore A
- Nylon
- Fluoropolymer

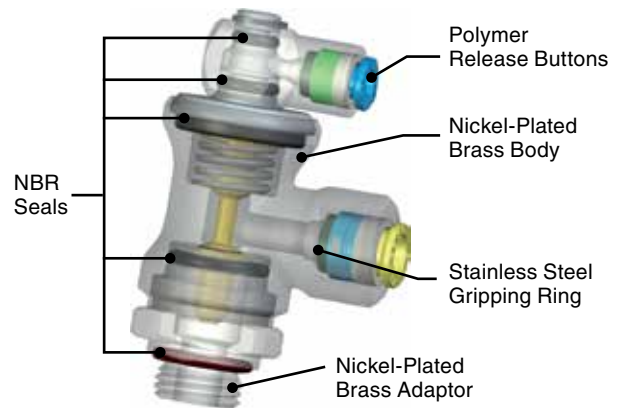

Specifications:

Pressure Range 15 to 145 PSI (1.0 to 9.9 bar)

Temperature Range -4° to +160° F (-20° to +71.1° C)

Leak Rate <3.2CCM

Number of Cycles >10 Million at 68°F and 1 HZ

Assembly Instructions

1. Cut tubing squarely – maximum of 15° angle allowable.
2. Check that port or mating part is clean and free of debris.
3. Mark tubing to appropriate tube insertion length. (see Tube Insertion Chart on page N22)
4. Insert tubing until it bottoms
5. Pull on tubing to verify it is fully inserted
6. To disassemble, simply press release button, hold against body and pull tubing out of fitting.

Operation

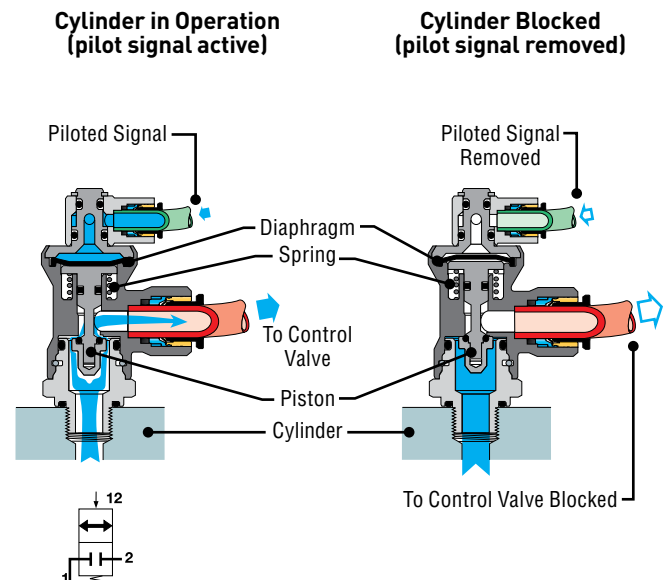

WARNING These products can expose you to chemicals including NICKEL or LEAD, which are known to the state of California to cause cancer, and LEAD which is known to cause birth defects or other reproductive harm. For more information go to www.P65Warnings.ca.gov.

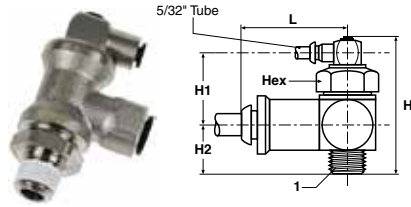

FC601 Push-to-Connect Lock Out Valves

PART NO.	TUBE SIZE IN	NPT	HEX MM	H	H1	H2	L
FC601-4-2	1/4	1/8	21	2.03	1.24	.79	1.10
FC601-4-4	1/4	1/4	21	2.03	1.24	.79	1.10
FC601-6-6	3/8	3/8	24	2.19	1.14	1.04	1.38
FC601-8-8	1/2	1/2	24	2.19	1.14	1.04	1.69

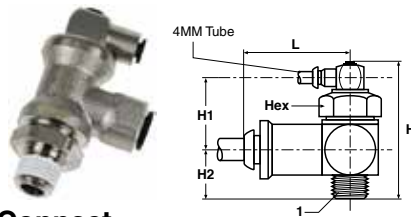

FC601 Push-to-Connect Lock-Out Valve - BSPT

PART NO.	TUBE SIZE MM	BSPT	HEX	H	H1	H2	L
FC601-6M-2R	6	1/8	21	53	24.5	21.0	28.0
FC601-6M-4R	6	1/4	21	53	24.5	21.0	28.0
FC601-8M-4R	8	1/4	21	53	24.5	21.0	28.0
FC601-8M-6R	8	3/8	24	56	25.0	23.0	34.5
FC601-10M-6R	10	3/8	24	56	25.0	23.0	35.0
FC601-12M-8R	12	1/2	24	56	25.0	23.0	37.5

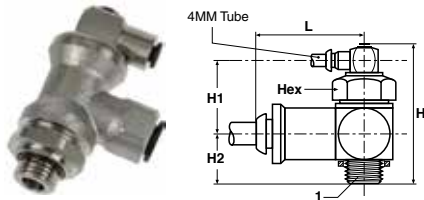

FC601 Push-to-Connect Lock-Out Valve - BSPP

PART NO.	TUBE SIZE MM	BSPP	HEX	H	H1	H2	L
FC601-6M-2G	6	1/8	21	53	24.5	21.0	28.0
FC601-6M-4G	6	1/4	21	53	24.5	21.0	28.0
FC601-8M-4G	8	1/4	21	53	24.5	21.0	28.0
FC601-8M-6G	8	3/8	24	56	25.0	23.0	34.5
FC601-10M-6G	10	3/8	24	56	25.0	23.0	35.0
FC601-12M-8G	12	1/2	24	56	25.0	23.0	37.5

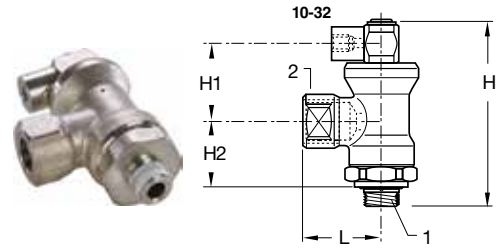

FC602 Threaded Port Lock Out Valves

PART NO.	1 NPT	2 NPT	HEX MM	H	H1	H2	L
FC602-2	1/8	1/8	21	2.03	1.24	.79	1.04
FC602-4	1/4	1/4	21	2.03	1.24	.79	1.04
FC602-6	3/8	3/8	24	2.19	1.14	1.04	1.34
FC602-8	1/2	1/2	24	2.19	1.14	1.04	1.57

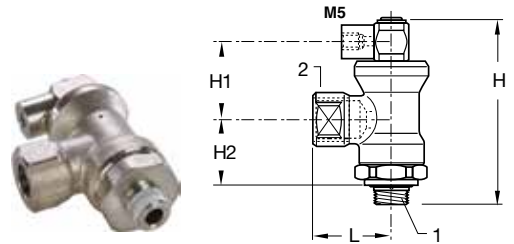

FC608 Threaded Port Lock-Out Valve - BSPT

PART NO.	BSPT 1	BSPT 2	HEX	H	H1	H2	L
FC608-4R-2R	1/4	1/8	21	51.5	31.5	20.0	26.5
FC608-4R-4R	1/4	1/4	21	51.5	31.5	20.0	26.5
FC608-6R-6R	3/8	3/8	24	55.5	29.0	26.5	34.0
FC608-8R-8R	1/2	1/2	24	55.5	29.0	26.5	40.0

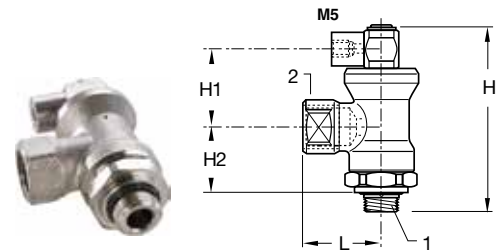

FC608 Threaded Port Lock-Out Valve - BSPP

PART NO.	BSPP 1	BSPP 2	HEX	H	H1	H2	L
FC608-4G-2G	1/8	1/4	21	53	24.5	21.0	28.0
FC608-4G-4G	1/4	1/4	21	53	24.5	21.0	28.0
FC608-6G-6G	3/8	3/8	24	56	25.0	23.0	34.0
FC608-8G-8G	1/2	1/2	24	56	25.0	23.0	41.0

WARNING These products can expose you to chemicals including NICKEL or LEAD, which are known to the state of California to cause cancer, and LEAD which is known to cause birth defects or other reproductive harm. For more information go to www.P65Warnings.ca.gov.

Slow Start Valves



Parker's Slow Start Valves enables you to control the rate supply pressures introduced into your system after it has been vented (e.g. at the end of the work day, emergency stops, or adjustments). Slow start valves gradually returns cylinders to the position they were in before the system was vented.

Product Features:

- Nickel-plated brass body
- Stainless steel gripping ring
- Nickel-plated brass threads
- Nitrile seals
- Silicone free

Markets:

- Factory/Process Automation
- Packaging
- Petrochemical
- Pneumatics

Applications:

- Robotics
- Packaging
- Textile
- Machine Tools
- Pneumatic Systems

Specifications:

Pressure Range 40 to 145 PSI (2.7 to 9.9 bar)

Temperature Range +5° to +140° F (-15° to +60° C)

Compatible Tubing:

- Semi-rigid nylon
- Polyurethane 95 Durometer Shore A
- Nylon
- Fluoropolymer

Operation

Filter, Regulator, Lubricator

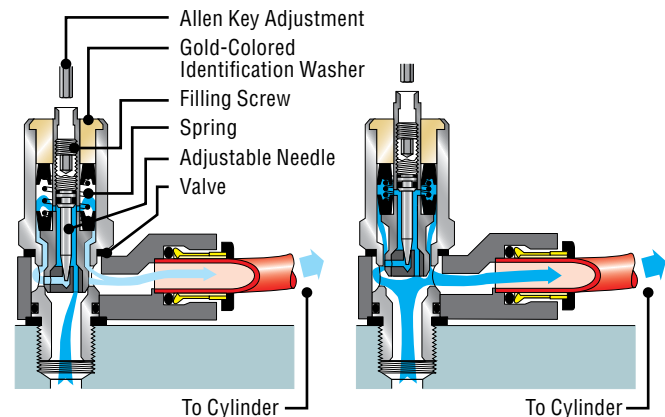

Assembly Instructions

1. Cut tubing squarely – maximum of 15° angle allowable.
2. Check that port or mating part is clean and free of debris.
3. Mark tubing to appropriate tube insertion length. (see Tube Insertion Chart on page N22)
4. Insert tubing until it bottoms
5. Pull on tubing to verify it is fully inserted
6. To disassemble, simply press release button, hold against body and pull tubing out of fitting.

WARNING These products can expose you to chemicals including NICKEL or LEAD, which are known to the state of California to cause cancer, and LEAD which is known to cause birth defects or other reproductive harm. For more information go to www.P65Warnings.ca.gov.

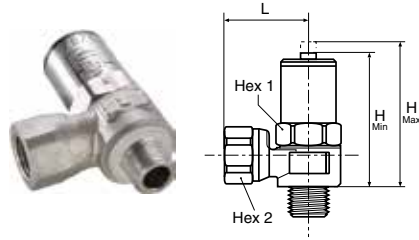

FC908 Slow Start Valve for System Isolating

PART NO.	NPT	HEX 1 MM	HEX 2 MM	H MIN	H MAX	L
FC908-4	1/4	7/8	3/4	2.17	2.44	1.22
FC908-6	3/8	7/8	3/4	2.17	2.44	1.36

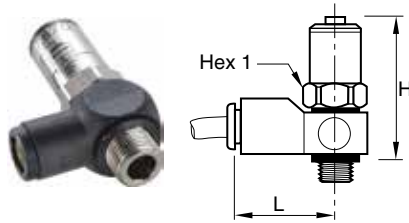

FC908 Push-to-Connect Slow Start Valve - BSPP for Isolated Component

PART NO.	TUBE SIZE MM	BSPP	HEX 1	H CLOSED	H OPEN	L
FC908-8M-4G	8	1/4	17	54	61	35
FC908-10M-4G	10	1/4	22	55	62	41
FC908-10M-6G	10	3/8	22	55	62	41

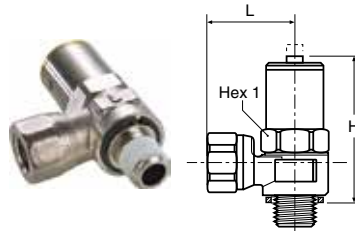

FCIC908 Slow Start Valve - BSPP for Isolated Component

PART NO.	BSPP	HEX 1	H CLOSED	H OPEN	L
FCIC908-6G	3/8	22	55	62	31

WARNING These products can expose you to chemicals including NICKEL or LEAD, which are known to the state of California to cause cancer, and LEAD which is known to cause birth defects or other reproductive harm. For more information go to www.P65Warnings.ca.gov.

Threshold Sensor Fittings



Parker's Threshold Sensor Fitting detects the pressure drop when a cylinder reaches the end of its stroke. They produce a pneumatic or electrical output signal when the pressure drop in the exhaust chamber of the cylinder goes below their back pressure threshold.

Product Features:

- Polymer body
- Brass screw
- NBR seal

Markets:

- Factory/Process Automation
- Packaging
- Pneumatics
- Semi-Conductor

Applications:

- Robotics
- Packaging
- Textile
- Machine Tools
- Pneumatic Systems

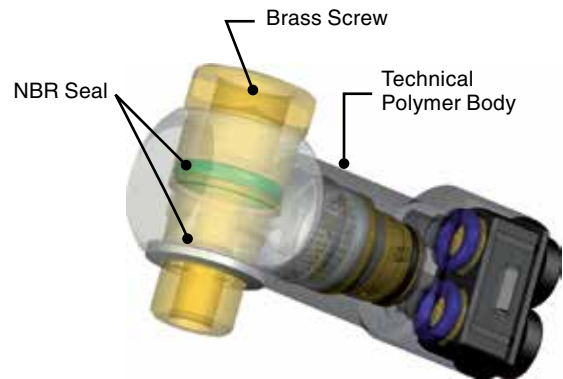

Specifications: Model PSBJ,PSPJ

Pressure Range	45 to 115 PSI (3.1 to 7.9 bar)
Temperature Range	+5° to +140° F (-15° to +60° C)
Breaking Pressure	8.5 PSI (0.5 bar)
Response Time	3 MS

Model PSPE

Pressure Range	45 to 115 PSI (3.1 to 7.9 bar)
Breaking Pressure	8.5 PSI (0.5 bar)
Current Rating	5A/250VAC – 5W/48VDC

Compatible Tubing:

- Semi-rigid nylon
- Polyurethane 95 Durometer Shore A
- Nylon
- Fluoropolymer

Operation

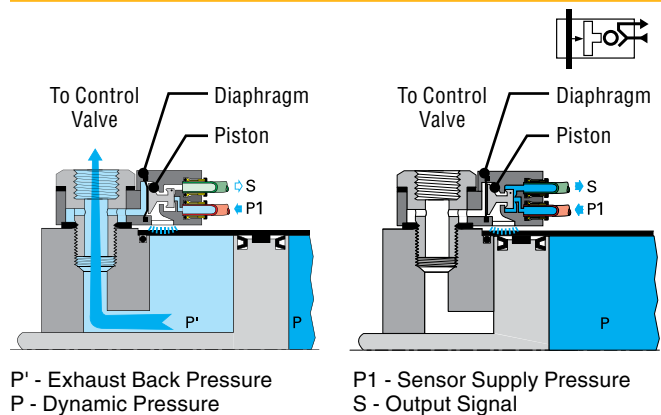

WARNING These products can expose you to chemicals including NICKEL or LEAD, which are known to the state of California to cause cancer, and LEAD which is known to cause birth defects or other reproductive harm. For more information go to www.P65Warnings.ca.gov.



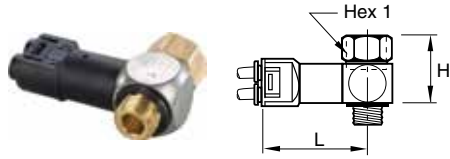

PSBJ731 Pneumatic Threshold Sensor - 5/32 Pilot

PART NO.	NPT / UNF	HEX MM	H	L
PSBJ731-0	10-32	5/16	.62	1.70
PSBJ731-2	1/8	9/16	.90	1.74
PSBJ731-4	1/4	5/8	1.09	1.81
PSBJ731-6	3/8	7/8	1.13	1.91
PSBJ731-8	1/2	1	1.17	2.05

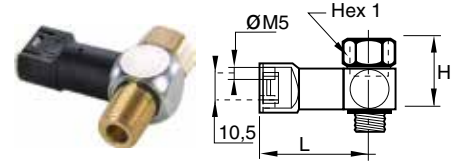

PSBJ708 Pneumatic Threshold Sensor - M5 Pilot

PART NO.	BSPP	HEX 1	H	L
PSBJ708-2G	1/8	14	23	40.5
PSBJ708-4G	1/4	17	28	42.5

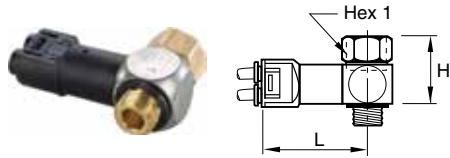

PSBJ731 Pneumatic Threshold Sensor - 4mm Pilot

PART NO.	BSPP	HEX 1	H	L
PSBJ731-M5	M5X0.8	8	16	43.5
PSBJ731-2G	1/8	14	23	44.5
PSBJ731-4G	1/4	17	28	46.5
PSBJ731-6G	3/8	22	29	49.0
PSBJ731-8G	1/2	27	30	52.5

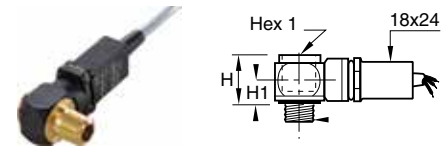

PSPE731 Pneumatic / Electric Threshold Sensor - BSPP

PART NO.	BSPP	HEX 1	H	H1	L
PSPE731-M5	M5X0.8	8	20	10	49
PSPE731-2G	1/8	6	20	10	52
PSPE731-4G	1/4	8	20	10	54
PSPE731-6G	3/8	10	22	12	57
PSPE731-8G	1/2	12	26	14	58

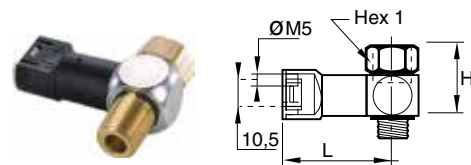

PSPJ731 Pneumatic Threshold Sensor - 10-32 Pilot

PART NO.	NPT	HEX 1 MM	H	L
PSPJ731-2	1/8	9/16	.90	1.58
PSPJ731-4	1/4	5/8	1.09	1.66
PSPJ731-6	3/8	7/8	1.13	1.76

WARNING These products can expose you to chemicals including NICKEL or LEAD, which are known to the state of California to cause cancer, and LEAD which is known to cause birth defects or other reproductive harm. For more information go to www.P65Warnings.ca.gov.

Mini Ball Valves



Parker's Mini Ball Valves enable in-line opening and closing of a pneumatic circuit. Handles are color coded and marked with the corresponding pneumatic symbol, in order to enable immediate identification by the user.

Product Features:

- Nylon body
- Brass stem
- Stainless steel gripping ring
- NBR stem seal
- NBR o-ring
- Nylon Handle
- Lightweight and compact

Markets:

- Factory/Process Automation
- Packaging
- Petrochemical
- Pneumatics
- Semi-Conductor

Applications:

- Robotics
- Packaging
- Textile
- Machine Tools
- Pneumatic Systems
- Vacuum

Specifications:

Pressure Range 145 PSI (9.9 bar)

Temperature Range -4° to 175° F (-20° to +79.4° C)

Vacuum Capability 28" Hg

Compatible Tubing:

- Semi-rigid nylon
- Polyurethane 95 Durometer Shore A
- Nylon
- Fluoropolymer

Operation

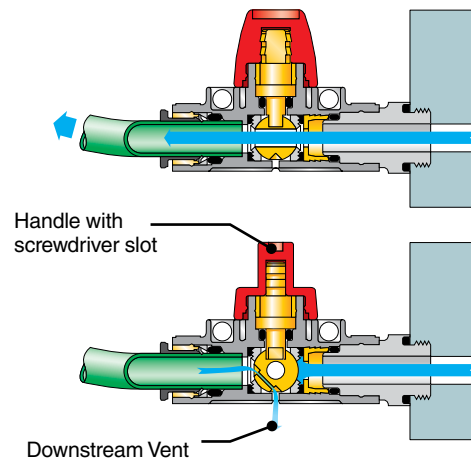

WARNING These products can expose you to chemicals including NICKEL or LEAD, which are known to the state of California to cause cancer, and LEAD which is known to cause birth defects or other reproductive harm. For more information go to www.P65Warnings.ca.gov.



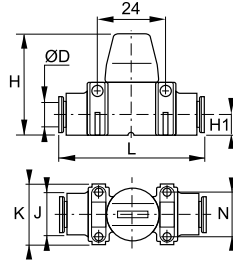

MVV309 Mini Ball Valve
Vented Push-To-Connect Ports

PART NO.	TUBE SIZE IN	H	H1	J	K	L	N
MVV309-4	1/4	1.46	.30	.59	.87	2	.64
MVV309-6	3/8	1.69	.43	.79	1.18	2.6	.87
METRIC							
MVV309-4M (5/32)	4	37.00	7.50	15.00	22.00	51	16.20
MVV309-6M	6	37.00	7.50	15.00	22.00	52	16.20
MVV309-8M (5/16)	8	37.00	7.50	15.00	22.00	52	16.20
MVV309-10M	10	43.00	11.00	20.00	30.00	66	22.00
MVV309-12M	12	43.00	11.00	20.00	30.00	66	22.00

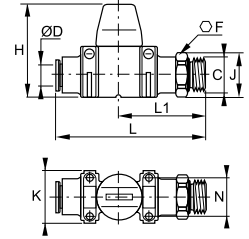

MVV308 Mini Ball Valve
Vented BSP to Push-To-Connect Port

PART NO.	TUBE SIZE MM	BSP	F	H	J	K	L	L1	N
MVV308-6M-2G	6	G1/8	13	37	14.00	22	62	37	16.20
MVV308-8M-4G	8	G1/4	16	37	17.50	22	61	35	16.20
MVV308-10M-6G	10	G3/8	20	43	22.00	30	74	41	22.00

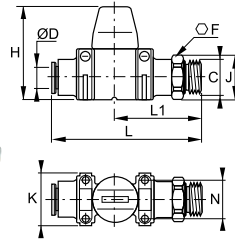

MVV308 Mini Ball Valve
Vented NPT to Push-To-Connect Port

PART NO.	TUBE SIZE IN	NPT	F	H	J	K	L	L1	N
MVV308-5/32-2	5/32	1/8	13	1.46	.55	.87	2.44	1.46	.64
MVV308-4-2	1/4	1/8	13	1.46	.55	.87	2.44	1.46	.64
MVV308-4-4	1/4	1/4	14	1.46	.59	.87	2.44	1.38	.64
MVV308-5-4	5/16	1/4	14	1.46	.59	1.18	2.40	1.61	.64
MVV308-6-4	3/8	1/4	16	1.69	.69	1.18	2.40	1.65	.87
MVV308-6-6	3/8	3/8	18	1.69	.77	1.18	2.91	1.65	.87

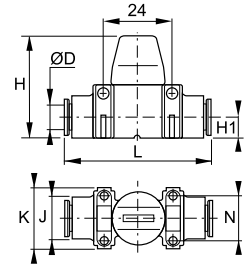

MV309 Mini Ball Valve
Push-To-Connect Ports

PART NO.	TUBE SIZE IN	H	H1	J	K	L	N
MV309-4	1/4	1.46	.30	.59	.87	2.05	.64
MV309-6	3/8	1.69	.43	.79	1.18	2.60	.64
METRIC							
MV309-4M (5/32)	4	37.00	7.50	15.00	22.00	51.00	16.20
MV309-6M	6	37.00	7.50	15.00	22.00	52.00	16.20
MV309-8M (5/16)	8	37.00	7.50	15.00	22.00	52.00	16.20
MV309-10M	10	43.00	11.00	20.00	30.00	66.00	16.20
MV309-12M	12	43.00	11.00	20.00	30.00	66.00	16.20

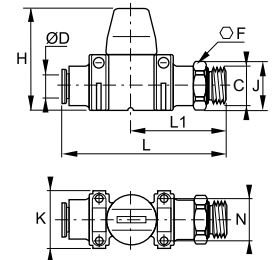

MV308 Mini Ball Valve
BSP to Push-To-Connect Port

PART NO.	TUBE SIZE MM	BSP	F	H	J	K	L	L1	N
MV308-6M-2G	6	G1/8	13	37	14	22	62	37	16.20
MV308-10M-6G	10	G3/8	20	43	22	30	74	41	16.20
MV308-12M-8G	12	G1/2	24	43	26	30	75	42	16.20

WARNING These products can expose you to chemicals including NICKEL or LEAD, which are known to the state of California to cause cancer, and LEAD which is known to cause birth defects or other reproductive harm. For more information go to www.P65Warnings.ca.gov.





Water & Beverage: Thermoplastic Fittings and Valves

LIQUIfit Fittings

TrueSeal™ Fittings

Fast & Tite® Fittings

Par-Barb® Fittings





LIQUIfit Fittings



Parker's LIQUIfit Fittings offers an "eco-designed" innovative alternative for water applications; no fluid contamination occurs and environmental protection is guaranteed.

Product Features:

- Stainless steel grab ring
- Bio-sourced nylon 11
- EPDM D – seal
- FDA compliant, NSF/ANSI 51 and NSF/ANSI 61
- Silicone free
- 100% leak tested in production
- Date coding to guarantee quality and traceability

Markets:

- Water Filtration
- Beverage Dispensing
- Life Science
- Bottling
- Semi-Conductor

Applications:

- Water
- Beverages
- Food
- CO₂
- Vacuum

Specifications:

Pressure Range Up to 230 PSI (16 bar)

Temperature Range +35° to +200° F (+1.7° to +93.3° C)

Note: The working specification depends on the type and wall thickness of the tube, the type of fluid, fluid Temperature and ambient temperature

Compatible Tubing:

- Polyethylene

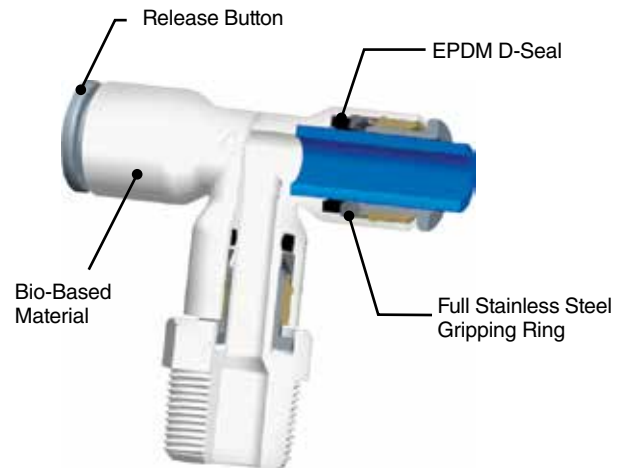







































Assembly Instructions

1. Cut tubing squarely – maximum of 15° angle allowable.
2. Check that port or mating part is clean and free of debris.
3. Mark tubing to appropriate tube insertion length. (see Tube Insertion Chart on page N22)
4. Insert tubing until it bottoms
5. Pull on tubing to verify it is fully inserted
6. To disassemble, simply press release button, hold against body and pull tubing out of fitting.

WARNING These products can expose you to chemicals including CARBON BLACK, or LEAD, which are known to the state of California to cause cancer, and LEAD which is known to cause birth defects or other reproductive harm. For more information go to www.P65Warnings.ca.gov.



Tube to Male NPTF	6548 Male Y Connector  p. C13	6505 Male Connector  p. C7	6579 Male Elbow  p. C8	6521 Male Standpipe  p. C8	6509 Male Elbow Swivel  p. C8	6508 Branch Tee Swivel  p. C9
	6503 Run Tee Swivel  p. C9	Tube to Male BSPT	6505 Male Connector  p. C7	6579 Male Elbow  p. C8	6521 Male Standpipe  p. C8	6509 Male Elbow Swivel  p. C9
6503 Run Tee Swivel  p. C10	Tube to Female Connector		6325 Faucet Connector - UNS  p. C8	6315 Female Connector - NPTF  p. C7	6315 Female Connector - BSPT  p. C7	Tube to Tube
6304 Union Tee  p. C10		6302 Union Elbow  p. C11	6340 Union Y  p. C11	Bulkhead Union	6316 Bulkhead Union  p. C7	
6388 Plug-In Branch Tee  p. C12	6382 Plug-In Elbow  p. C12	6383 Plug-In Run Tee  p. C12	Auxiliary Components		6351 End Cap  p. C12	6326 Plug  p. C13
Metric Tube to Metric Tube	6306 Union  p. C10	6404 Union Tee  p. C10		6302 Union Elbow  p. C11	6340 Union Y  p. C11	6307 Cross  p. C13
	6316 Metric Bulkhead Union  p. C7	Metric Plug-Ins	6366 Tube Reducer  p. C11	6388 Plug-In Branch Tee  p. C12	6382 Plug-In Elbow  p. C12	6383 Plug-In Run Tee  p. C13
6380 Plug-In 45° Elbow  p. C13	Metric Auxiliary Components		6351 End Cap  p. C12	6326 Plug  p. C13	6322 Barbed Connector  p. C13	Liquifit Ball Valves

WARNING These products can expose you to chemicals including CARBON BLACK, or LEAD, which are known to the state of California to cause cancer, and LEAD which is known to cause birth defects or other reproductive harm. For more information go to www.P65Warnings.ca.gov.

VFE
Female Elbow



p. C14

VUC
Union Connector



p. C14

VEU
Elbow Union



p. C15

VMC
Male Connector



p. C15

VFC
Female Connector



p. C15

VAS
Valve Angle Stop



p. C16

 **WARNING** These products can expose you to chemicals including CARBON BLACK, or LEAD, which are known to the state of California to cause cancer, and LEAD which is known to cause birth defects or other reproductive harm. For more information go to www.P65Warnings.ca.gov.



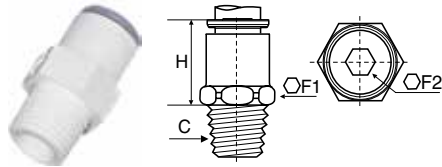

6505 Male Connector Inch Tube to NPTF

PART NO.	TUBE SIZE IN	C NPTF	F1	F2	H
6505 56 11WP2	1/4	1/8	1/2	5/32	.67
6505 56 14WP2	1/4	1/4	9/16	5/32	.67
6505 56 18WP2	1/4	3/8	3/4	1/4	.85
6505 60 11WP2	3/8	1/8	3/4	5/32	.87
6505 60 14WP2	3/8	1/4	3/4	1/4	.87
6505 60 18WP2	3/8	3/8	3/4	1/4	.87
6505 60 22WP2	3/8	1/2	15/16	1/4	1.06
6505 62 18WP2	1/2	3/8	15/16	3/8	1.10
6505 62 22WP2	1/2	1/2	15/16	3/8	1.10

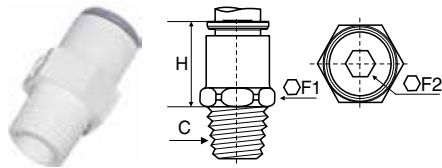

6505 Male Connector Metric Tube to BSPT

PART NO.	TUBE SIZE MM	C BSPT	F1	F2	H
6505 04 10WP2	4	1/8	11	3	18.00
6505 04 13WP2	4	1/4	14	3	18.00
6505 06 10WP2	6	1/8	11	4	18.00
6505 06 13WP2	6	1/4	14	4	18.00
6505 08 10WP2	8	1/8	17	6	20.00
6505 08 13WP2	8	1/4	17	6	20.00
6505 08 17WP2	8	3/8	17	6	20.00
6505 10 13WP2	10	1/4	17	7	21.50
6505 10 17WP2	10	3/8	19	7	21.50
6505 10 21WP2	10	1/2	22	7	21.50
6505 12 17WP2	12	3/8	19	9	24.50
6505 12 21WP2	12	1/2	22	9	24.50

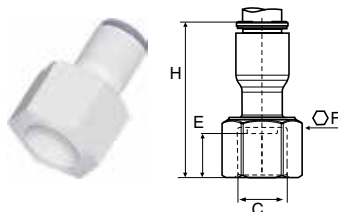

6315 Female Connector Inch Tube to NPTF

PART NO.	TUBE SIZE IN	C NPTF	E	F	H
6315 56 14WP2	1/4	1/4	14	11/16	1.18
6315 60 18WP2	3/8	3/8	14	3/16	1.42

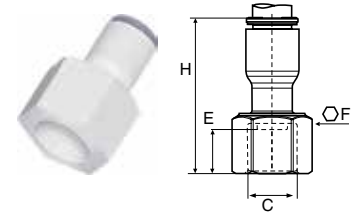

6315 Female Connector Metric Tube to BSPT

PART NO.	TUBE SIZE MM	C BSPT	E	F	H
6315 06 10WP2	6	1/8	11	13	32.00
6315 06 13WP2	6	1/4	14	16	33.00
6315 08 13WP2	8	1/4	14	16	33.50
6315 08 17WP2	8	3/8	14	20	36.00

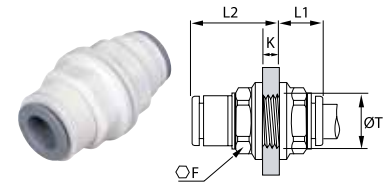

6316 Bulkhead Union Inch Tube

PART NO.	TUBE SIZE IN	F	K MAX	L1	L2	T MIN
6316 04 00WP2	5/32	.51	.22	.41	.61	.41
6316 56 00WP2	1/4	.59	.33	.39	.79	.49
6316 08 00WP2	5/16	.71	.57	.41	1.06	.61
6316 60 00WP2	3/8	.87	.57	.49	1.16	.73
6316 62 00WP2	1/2	1.41	.81	.67	1.59	1.00

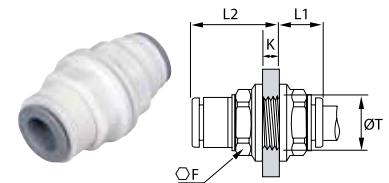

6316 Bulkhead Union Metric Tube

PART NO.	TUBE SIZE MM	F	K MAX	L1	L2	T MIN
6316 04 00WP2	4	13	5.50	10.50	15.50	10.50
6316 06 00WP2	6	15	8.50	10.00	20.00	12.50
6316 08 00WP2	8	18	14.50	10.50	27.00	15.50
6316 10 00WP2	10	22	14.50	13.00	30.00	18.50
6316 12 00WP2	12	26	18.50	15.50	35.00	22.50

WARNING These products can expose you to chemicals including CARBON BLACK, or LEAD, which are known to the state of California to cause cancer, and LEAD which is known to cause birth defects or other reproductive harm. For more information go to www.P65Warnings.ca.gov.

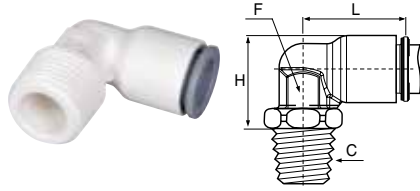

6579 Fixed Elbow Inch Tube to NPTF

PART NO.	TUBE SIZE IN	C NPTF	F	H	L
6579 56 11WP2	1/4	1/8	3/8	.87	.71
6579 56 14WP2	1/4	1/4	3/8	1.03	.71
6579 56 18WP2	1/4	3/8	3/8	1.04	.71
6579 60 14WP2	3/8	1/4	1/2	1.26	1.02
6579 60 18WP2	3/8	3/8	1/2	1.26	1.02

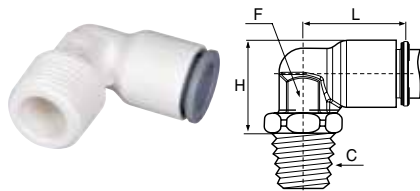

6579 Fixed Elbow Metric Tube to BSPT

PART NO.	TUBE SIZE MM	C BSPT	F	H	L
6579 06 10WP2	6	1/8	10	14	19
6579 06 13WP2	6	1/4	10	14	19
6579 06 17WP2	6	3/8	10	14	19

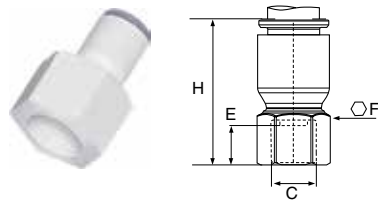

6325 Faucet Connector Inch Tube to UNS

PART NO.	TUBE SIZE IN	C UNS	E	F	H
6325 56 133WP2	1/4	7/16-24	27	9/16	1.22
6325 60 133WP2	3/8	7/16-24	27	9/16	1.26

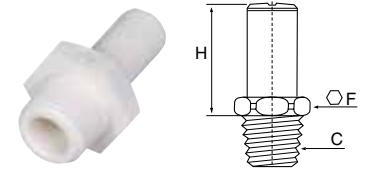

6521 Stem Adapter Inch Tube to NPTF

PART NO.	TUBE SIZE IN	C NPTF	F	H
6521 56 11WP2	1/4	1/8	1/2	.75
6521 56 14WP2	1/4	1/4	1/2	.75
6521 56 18WP2	1/4	3/8	3/4	.77
6521 60 14WP2	3/8	1/4	3/4	.98
6521 60 18WP2	3/8	3/8	3/4	.98
6521 62 18WP2	1/2	3/8	15/16	1.22
6521 62 22WP2	1/2	1/2	15/16	1.28

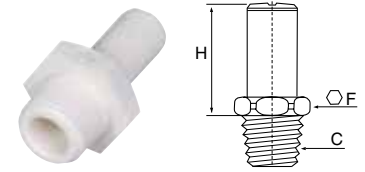

6521 Stem Adapter Metric Tube to BSPT

PART NO.	TUBE SIZE MM	C BSPT	F	H
6521 06 10WP2	6	1/8	13	19
6521 06 13WP2	6	1/4	14	19
6521 06 17WP2	6	3/8	17	19
6521 08 10WP2	8	1/8	19	23
6521 08 13WP2	8	1/4	19	23
6521 08 17WP2	8	3/8	19	23
6521 10 13WP2	10	1/4	19	25
6521 10 17WP2	10	3/8	19	25
6521 10 21WP2	10	1/2	22	25
6521 12 17WP2	12	3/8	22	28
6521 12 21WP2	12	1/2	22	28

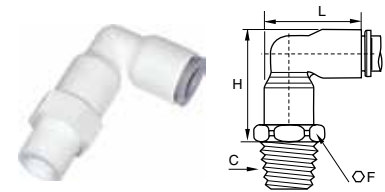

6509 Swivel Elbow Inch Tube to NPTF

PART NO.	TUBE SIZE IN	C NPTF	F	H	L
6509 56 11WP2	1/4	1/8	1/2	1.10	.93
6509 56 14WP2	1/4	1/4	9/16	1.10	.93
6509 56 18WP2	1/4	3/8	3/4	1.12	.93
6509 60 14WP2	3/8	1/4	3/4	1.50	1.34
6509 60 18WP2	3/8	3/8	3/4	1.50	1.34
6509 62 18WP2	1/2	3/8	15/16	1.99	1.83
6509 62 22WP2	1/2	1/2	15/16	1.99	1.83

WARNING These products can expose you to chemicals including CARBON BLACK, or LEAD, which are known to the state of California to cause cancer, and LEAD which is known to cause birth defects or other reproductive harm. For more information go to www.P65Warnings.ca.gov.

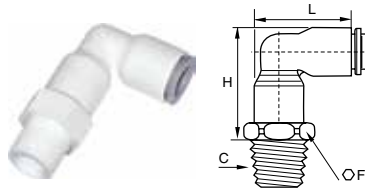

6509 Swivel Elbow Metric Tube to BSPT

PART NO.	TUBE SIZE MM	C BSPT	F	H	L
6509 06 10WP2	6	1/8	13	28	24.00
6509 06 13WP2	6	1/4	14	28	24.00
6509 06 17WP2	6	3/8	17	28	24.00
6509 08 10WP2	8	1/8	19	34	29.50
6509 08 13WP2	8	1/4	19	34	29.50
6509 08 17WP2	8	3/8	19	34	29.50
6509 10 13WP2	10	1/4	19	38	34.50
6509 10 17WP2	10	3/8	19	38	34.50
6509 10 21WP2	10	1/2	22	38	34.50
6509 12 17WP2	12	3/8	22	44	40.00
6509 12 21WP2	12	1/2	22	44	40.00

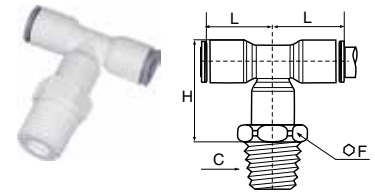

6508 Swivel Branch Tee Metric Tube to BSPT

PART NO.	TUBE SIZE MM	C BSPT	F	H	L
6508 06 10WP2	6	1/8	13	28.00	18.00
6508 06 13WP2	6	1/4	14	28.00	18.00
6508 06 17WP2	6	3/8	17	28.00	18.00
6508 08 10WP2	8	1/8	19	34.00	23.00
6508 08 13WP2	8	1/4	19	34.00	23.00
6508 08 17WP2	8	3/8	19	34.00	23.00
6508 10 13WP2	10	1/4	19	38.00	26.50
6508 10 17WP2	10	3/8	19	38.00	26.50
6508 10 21WP2	10	1/2	22	38.00	26.50
6508 12 17WP2	12	3/8	22	44.00	31.00
6508 12 21WP2	12	1/2	22	44.00	31.00

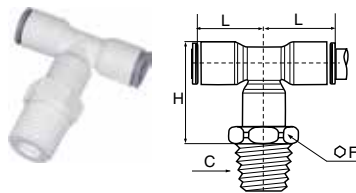

6508 Swivel Branch Tee Inch Tube to NPTF

PART NO.	TUBE SIZE IN	C NPTF	F	H	L
6508 56 11WP2	1/4	1/8	1/2	1.10	.71
6508 56 14WP2	1/4	1/4	9/16	1.10	.71
6508 56 18WP2	1/4	3/8	3/4	1.10	.71
6508 60 14WP2	3/8	1/4	3/4	1.50	1.02
6508 60 18WP2	3/8	3/8	3/4	1.50	1.02
6508 62 18WP2	1/2	3/8	15/16	1.97	1.40
6508 62 22WP2	1/2	1/2	15/16	2.00	1.40

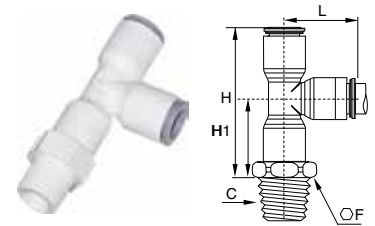

6503 Swivel Run Tee Inch Tube to NPTF

PART NO.	TUBE SIZE IN	C NPTF	F	H	H1	L
6503 56 11WP2	1/4	1/8	1/2	1.60	.88	.71
6503 56 14WP2	1/4	1/4	9/16	1.60	.88	.71
6503 56 18WP2	1/4	3/8	3/4	1.63	.90	.71
6503 60 14WP2	3/8	1/4	3/4	1.63	1.18	1.02
6503 60 18WP2	3/8	3/8	3/4	1.63	1.18	1.02
6503 62 18WP2	1/2	3/8	15/16	2.29	1.55	1.40
6503 62 22WP2	1/2	1/2	15/16	2.99	1.59	1.40

WARNING These products can expose you to chemicals including CARBON BLACK, or LEAD, which are known to the state of California to cause cancer, and LEAD which is known to cause birth defects or other reproductive harm. For more information go to www.P65Warnings.ca.gov.

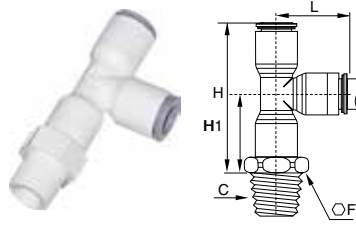

6503 Swivel Run Tee Metric Tube to BSPT

PART NO.	TUBE SIZE MM	C BSPT	F	H	H1	L
6503 06 10WP2	6	1/8	13	40.00	22.00	18.50
6503 06 13WP2	6	1/4	14	40.00	22.00	18.50
6503 06 17WP2	6	3/8	17	40.00	22.00	18.50
6503 08 10WP2	8	1/8	19	50.00	27.00	23.00
6503 08 13WP2	8	1/4	19	50.00	27.00	23.00
6503 08 17WP2	8	3/8	19	50.00	27.00	23.00
6503 10 13WP2	10	1/4	19	56.50	30.00	26.50
6503 10 17WP2	10	3/8	19	56.50	30.00	26.50
6503 10 21WP2	10	1/2	22	56.50	30.00	26.50
6503 12 17WP2	12	3/8	22	65.50	34.50	31.00
6503 12 21WP2	12	1/2	22	65.50	34.50	31.00

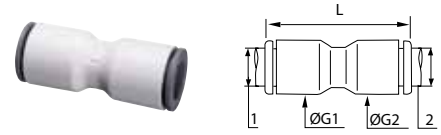

6306 Union Connector Metric Tube

PART NO.	TUBE 1 SIZE MM	TUBE 2 SIZE MM	G1	G2	L
6306 04 00WP2	4	4	8.50	8.50	26.50
6306 06 00WP2	6	6	10.50	10.50	30.00
6306 08 00WP2	8	8	13.50	13.50	37.00
6306 10 00WP2	10	10	16.00	16.00	42.00
6306 12 00WP2	12	12	19.00	19.00	50.50
6306 04 06WP2	4	6	8.50	10.50	29.00
6306 04 08WP2	4	8	13.50	13.50	37.00
6306 06 08WP2	6	8	13.50	13.50	37.00
6306 06 10WP2	6	10	16.00	16.00	42.00
6306 08 10WP2	8	10	16.00	16.00	42.00
6306 08 12WP2	8	12	19.00	19.00	50.00
6306 10 12WP2	10	12	19.00	19.00	50.00

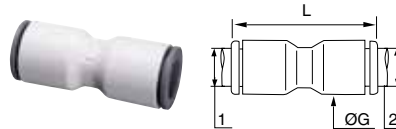

6306 Union Connector Inch Tube

PART NO.	TUBE 1 SIZE IN	TUBE 2 SIZE IN	G	L
6306 56 00WP2	1/4	1/4	.43	1.18
6306 08 00WP2	5/16	5/16	.53	1.46
6306 60 00WP2	3/8	3/8	.63	1.65
6306 62 00WP2	1/2	1/2	.87	2.24
6306 56 60WP2	1/4	3/8	.63	1.61
6306 56 08WP2	1/4	5/16	.53	1.46
6306 08 60WP2	5/16	3/8	.63	1.65
6306 08 62WP2	5/16	1/2	.87	2.16
6306 60 62WP2	3/8	1/2	.87	2.20

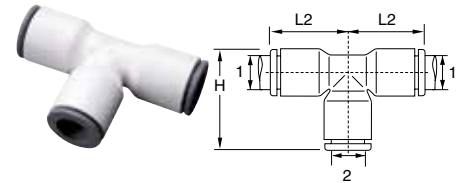

6304 Union Tee Inch Tube

PART NO.	TUBE 1 SIZE IN	TUBE 2 SIZE IN	H	L2
6304 04 00WP2	5/32	5/32	.79	.61
6304 56 00WP2	1/4	1/4	.94	.71
6304 08 00WP2	5/16	5/16	1.14	.89
6304 60 00WP2	3/8	3/8	1.34	1.02
6304 62 00WP2	1/2	1/2	1.85	1.42
6304 60 56WP2	3/8	1/4	1.34	1.02
6304 62 60WP2	1/2	3/8	1.85	1.42

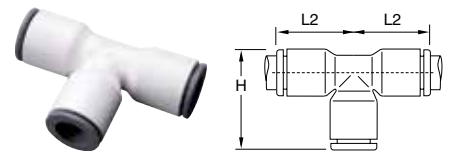

6304 Union Tee Metric Tube

PART NO.	TUBE SIZE MM	H	L2
6304 04 00WP2	4	20.00	15.50
6304 06 00WP2	6	23.00	18.00
6304 08 00WP2	8	29.00	22.50
6304 10 00WP2	10	34.50	26.50
6304 12 00WP2	12	40.00	31.00

WARNING These products can expose you to chemicals including CARBON BLACK, or LEAD, which are known to the state of California to cause cancer, and LEAD which is known to cause birth defects or other reproductive harm. For more information go to www.P65Warnings.ca.gov.

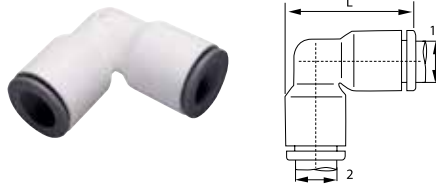

6302 Union Elbow Inch Tube

PART NO.	TUBE 1 SIZE IN	TUBE 2 SIZE IN	L
6302 04 00WP2	5/32	5/32	.75
6302 56 00WP2	1/4	1/4	.94
6302 08 00WP2	5/16	5/16	1.16
6302 60 00WP2	3/8	3/8	1.34
6302 62 00WP2	1/2	1/2	1.79
6302 56 08WP2	1/4	5/16	1.16
6302 08 60WP2	5/16	3/8	1.34
6302 56 60WP2	3/8	1/4	1.30
6302 60 62WP2	3/8	1/2	1.83

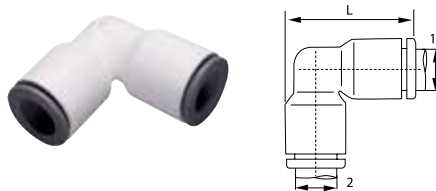

6302 Union Elbow Metric Tube

PART NO.	TUBE 1 SIZE MM	TUBE 2 SIZE MM	L
6302 04 00WP2	4	4	19.50
6302 06 00WP2	6	6	24.00
6302 08 00WP2	8	8	29.50
6302 10 00WP2	10	10	34.50
6302 12 00WP2	12	12	40.50
6302 04 06WP2	4	6	24.00
6302 06 08WP2	6	8	29.50
6302 08 10WP2	8	10	34.50
6302 10 12WP2	10	12	40.50

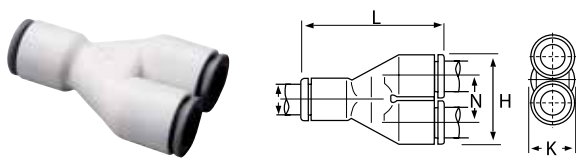

6340 Union Y Connector Inch Tube

PART NO.	TUBE SIZE IN	H	K	L	N
6340 04 00WP2	5/32	.69	.33	1.18	.35
6340 56 00WP2	1/4	.87	.43	1.42	.45
6340 08 00WP2	5/16	1.10	.53	1.75	.57
6340 60 00WP2	3/8	1.30	.63	2.08	.67
6340 62 00WP2	1/2	1.77	.87	2.64	.91

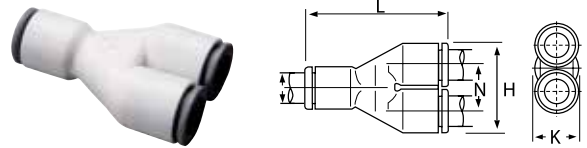

6340 Union Y Connector Metric Tube

PART NO.	TUBE SIZE MM	H	K	L	N
6340 04 00WP2	4	17.50	8.50	30.00	9.00
6340 06 00WP2	6	21.50	10.50	36.50	11.00
6340 08 00WP2	8	28.00	13.50	44.50	14.50
6340 10 00WP2	10	33.00	16.00	53.00	17.00
6340 12 00WP2	12	39.00	19.00	60.50	20.00

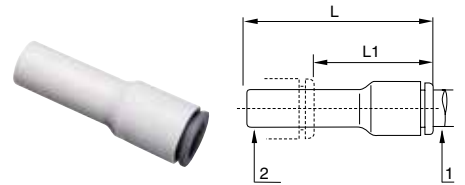

6366 Reducer Inch Tube to Stem

PART NO.	TUBE 1 SIZE IN	TUBE 2 SIZE IN	L	L1
6366 56 08WP2	1/4	5/16	1.61	.89
6366 56 60WP2	1/4	3/8	1.61	.81
6366 08 60WP2	5/16	3/8	1.91	1.14
6366 08 62WP2	5/16	1/2	1.91	.87
6366 60 62WP2	3/8	1/2	2.01	1.18

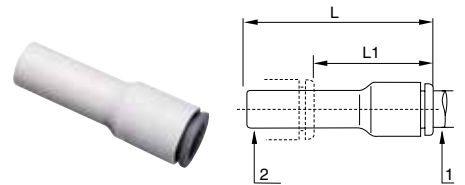

6366 Reducer Metric Tube to Stem

PART NO.	TUBE 1 SIZE MM	TUBE 2 SIZE MM	L	L1
6366 04 06WP2	4	6	38.00	23.50
6366 04 08WP2	4	8	38.00	19.00
6366 06 08WP2	6	8	38.00	20.00
6366 06 10WP2	6	10	39.00	17.50
6366 08 10WP2	8	10	48.50	28.50
6366 08 12WP2	8	12	48.50	24.50
6366 10 12WP2	10	12	52.00	33.50
6366 10 14WP2	10	14	53.00	33.50
6366 12 14WP2	12	14	55.50	33.50

WARNING These products can expose you to chemicals including CARBON BLACK, or LEAD, which are known to the state of California to cause cancer, and LEAD which is known to cause birth defects or other reproductive harm. For more information go to www.P65Warnings.ca.gov.

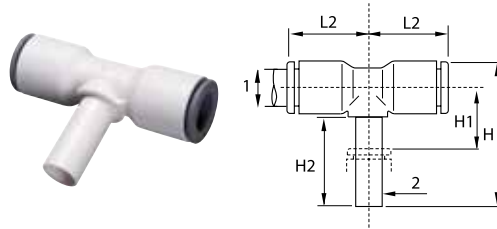

6388 Plug-In Tee Inch Tube to Stem

PART NO.	TUBE 1 SIZE IN	TUBE 2 SIZE IN	H	H1	H2	L2
6388 56 00WP2	1/4	1/4	1.20	.43	.79	.71
6388 08 00WP2	5/16	5/16	1.32	.31	.85	.90
6388 60 00WP2	3/8	3/8	1.65	.49	.98	.98
6388 62 00WP2	1/2	1/2	2.01	.51	1.14	1.26

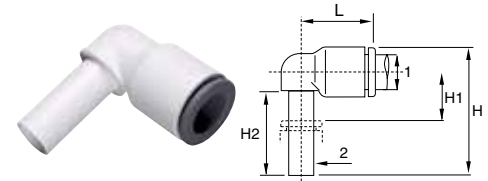

6382 Plug-In Elbow Inch Tube to Stem

PART NO.	TUBE 1 SIZE IN	TUBE 2 SIZE IN	H	H1	H2	L
6382 56 00WP2	1/4	1/4	1.20	.43	.71	.71
6382 08 00WP2	5/16	5/16	1.32	.31	.85	.88
6382 60 00WP2	3/8	3/8	1.53	.35	.96	1.04
6382 56 60WP2	1/4	3/8	1.93	.51	1.12	1.42
6382 60 56WP2	3/8	1/4	1.26	.43	.71	1.04

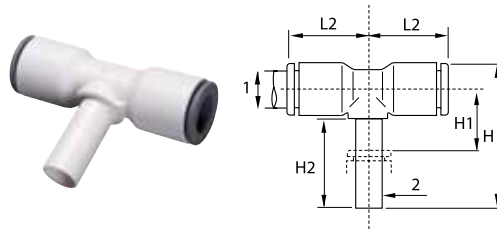

6388 Plug-In Tee Metric Tube to Stem

PART NO.	TUBE 1 SIZE MM	TUBE 2 SIZE MM	H	H1	H2	L2
6388 04 00WP2	4	4	25.00	6.00	15.50	15.00
6388 06 00WP2	6	6	28.50	7.00	17.00	16.00
6388 08 00WP2	8	8	33.50	8.00	21.50	23.00
6388 10 00WP2	10	10	41.00	9.50	24.50	26.50

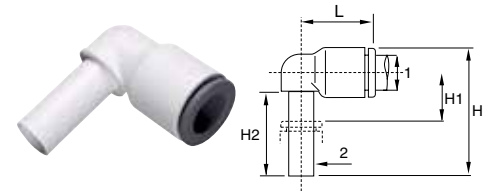

6382 Plug-In Elbow Metric Tube to Stem

PART NO.	TUBE 1 SIZE MM	TUBE 2 SIZE MM	H	H1	H2	L
6382 04 00WP2	4	4	23.00	6.00	15.50	15.00
6382 06 00WP2	6	6	26.50	7.00	17.00	17.00
6382 08 00WP2	8	8	33.00	8.00	21.50	22.50
6382 10 00WP2	10	10	39.00	9.50	24.50	26.50
6382 12 00WP2	12	12	44.50	10.00	27.00	31.00
6382 04 06WP2	4	6	26.50	7.00	17.00	16.50
6382 06 04WP2	6	4	25.00	7.00	15.50	17.00
6382 06 08WP2	6	8	33.50	8.00	21.50	22.50
6382 08 10WP2	8	10	39.00	9.50	24.50	26.00
6382 10 12WP2	10	12	44.50	10.00	27.00	30.00

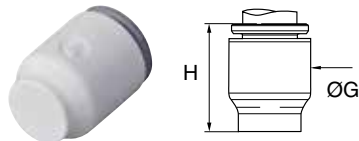

6351 End Stop Inch Tube

PART NO.	TUBE SIZE IN	G	H
6351 04 00WP2	5/32	.33	.59
6351 56 00WP2	1/4	.43	.63
6351 08 00WP2	5/16	.53	.85
6351 60 00WP2	3/8	.63	.88

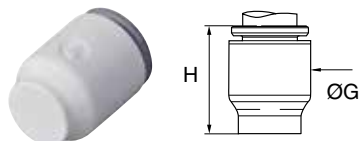

6351 End Stop Metric Tube

PART NO.	TUBE SIZE MM	G	H
6351 04 00WP2	4	8.50	15.00
6351 06 00WP2	6	10.50	17.00
6351 08 00WP2	8	13.50	21.50
6351 10 00WP2	10	16.00	22.00
6351 12 00WP2	12	19.00	27.50

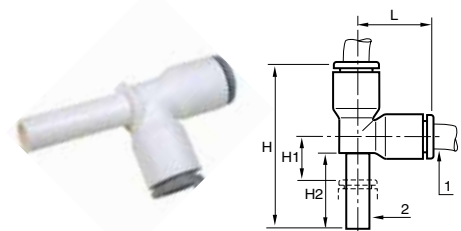

6383 Plug-In Run Tee Inch Tube to Stem

PART NO.	TUBE 1 SIZE IN	TUBE 2 SIZE IN	H	H1	H2	L
6383 56 00WP2	1/4	1/4	1.20	.43	.71	.71
6383 60 00WP2	3/8	3/8	2.24	.43	.96	1.04
6383 62 00WP2	1/2	1/2	1.93	.71	1.12	1.42

WARNING These products can expose you to chemicals including CARBON BLACK, or LEAD, which are known to the state of California to cause cancer, and LEAD which is known to cause birth defects or other reproductive harm. For more information go to www.P65Warnings.ca.gov.

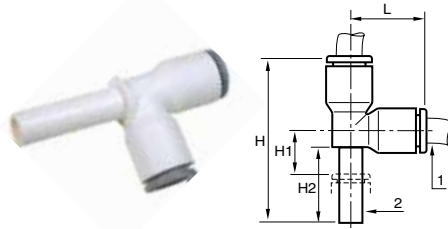

6383 Plug-In Run Tee Metric Tube to Stem

PART NO.	TUBE 1 SIZE MM	TUBE 2 SIZE MM	H	H1	H2	L
6383 04 00WP2	4	4	33.00	6.00	15.50	15.00
6383 06 00WP2	6	6	38.50	7.00	17.00	18.00
6383 08 00WP2	8	8	49.00	8.00	21.50	23.00
6383 10 00WP2	10	10	57.00	10.50	25.50	26.50

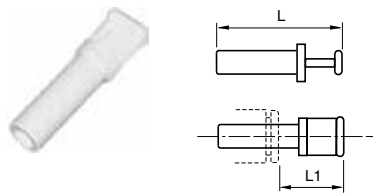

6326 Plug Inch

PART NUMBER	STEM SIZE IN	L	L1
6326 56 00WP2	1/4	1.44	.87
6326 08 00WP2	5/16	1.38	.69
6326 60 00WP2	3/8	1.67	.87
6326 62 00WP2	1/2	1.91	.85

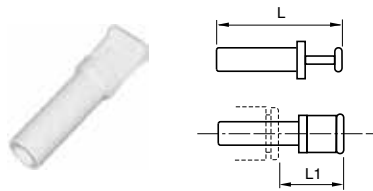

6326 Plug Metric

PART NUMBER	STEM SIZE MM	L	L1
6326 04 00WP2	4	30	15.5
6326 06 00WP2	6	33	16.5
6326 08 00WP2	8	33	17.5
6326 10 00WP2	10	42	21.0
6326 12 00WP2	12	45	22.0

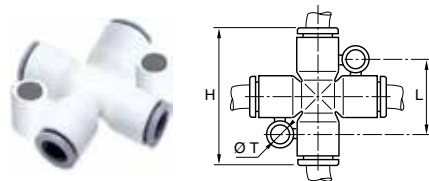

6307 Cross Metric

PART NUMBER	TUBE SIZE MM	H	L	T
6307 06 00WP2	6	46	22.5	4.2
6307 08 00WP2	8	46	22.5	4.2

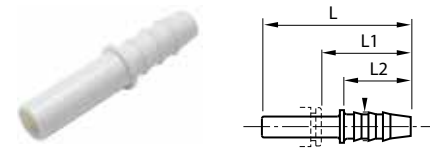

6322 Stem to Hose Barb Inch

PART NUMBER	STEM SIZE IN	HOSE BARB	L	L1	L2
6322 56 56WP2	1/4	1/4	1.65	1.00	.67
6322 60 56WP2	3/8	1/4	1.97	1.16	.87
6322 60 08WP2	3/8	5/16	1.97	1.16	.87
6322 60 60WP2	3/8	3/8	1.97	1.16	.87
6322 62 60WP2	1/2	3/8	2.05	1.30	1.07

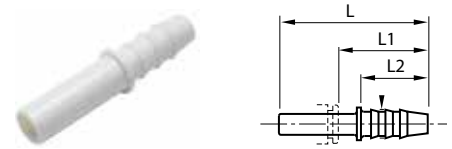

6322 Stem to Hose Barb Metric

PART NUMBER	STEM SIZE MM	HOSE BARB	L	L1	L2
6322 06 04WP2	6	4	37.0	25.0	17
6322 08 06WP2	8	6	39.5	21.0	17
6322 10 07WP2	10	7	50.0	29.5	22

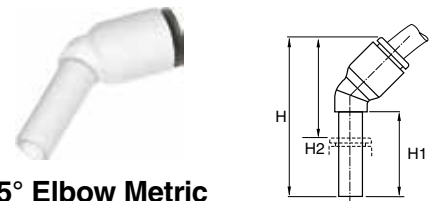

6380 Plug-in 45° Elbow Metric

PART NUMBER	TUBE SIZE MM	STEM SIZE MM	H	H1	H2
6380 04 00WP2	4	4	33.5	19.0	13.0
6380 06 00WP2	6	6	39.0	21.0	14.5
6380 08 00WP2	8	8	44.0	21.5	19.5
6380 10 00WP2	10	10	53.0	27.0	23.0
6380 12 00WP2	12	12	58.5	27.5	26.5

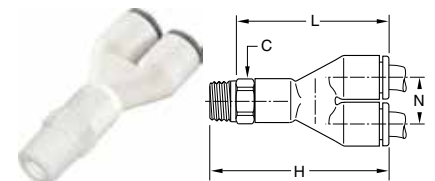

6548 Swivel Y Connector Inch Tube to NPTF

PART NUMBER	TUBE SIZE IN	NPTF	C HEX	L	H	N
6548 56 11WP2	1/4	1/8	1/2	1.59	.88	.45
6548 56 14WP2	1/4	1/4	1/2	1.59	.88	.45
6548 56 18WP2	1/4	3/8	3/4	1.62	.88	.45
6548 60 14WP2	3/8	1/4	3/4	2.24	1.30	.66
6548 60 18WP2	3/8	3/8	3/4	2.24	1.30	.66
6548 62 18WP2	1/2	3/8	15/16	2.80	1.78	.91
6548 62 22WP2	1/2	1/2	15/16	2.84	1.78	.91

WARNING These products can expose you to chemicals including CARBON BLACK, or LEAD, which are known to the state of California to cause cancer, and LEAD which is known to cause birth defects or other reproductive harm. For more information go to www.P65Warnings.ca.gov.

LIQUIfit Polypropylene Ball Valves

This range of valves offers an innovative solution in the treatment of water and the handling of beverages while protecting health. LIQUIfit's corrosion-resistant, all plastic design makes them ideal for water filtration units, coffee and beverage machines and a wide variety of other fluid applications. The polypropylene material meets all FDA and NSF-51 requirements for food contact.

Assembly Instructions:

1. Inspect the mating threads for debris or damage. Remove any old fluoropolymer tape or sealant on previously used threads. If threads are damaged, replace with new adapter before proceeding.
2. Apply 2 to 3 wraps of fluoropolymer tape, or an NSF/FDA approved silicone sealant. Do not use Plumbers Putty or Pipe Dope. These chemically react with plastic materials and could cause a failure.
3. Align ball valve onto mating thread to ensure cross threading does not occur.
4. Screw ball valve onto mating thread 3 to 5 turns. This should be sufficient to properly seal the threads.
5. Pressurize system and check for leaks.

Features/Benefits:

- Full-flow self-cleaning ball maintains the cleanliness of the circuit
- Sealing technology using EPDM D seal
- High temperature, scale-resistant Polysulfone ball
- Tube retention with gripping ring prevents pumping effect
- Push-in connection and disconnection
- FDA compliant

Specifications:

- Temperature range: +35° F to +200° F (+1° C to +93° C)
- O-ring seal material: EPDM
- NSF-51 Listed
- Pressure rated to 150 psi

Advantages:

- Reduce costs – Built-in LIQUIfit connection eliminates the need for a secondary fitting
- Save space – Low profile design allows for easy assembly and access where space is at a premium.

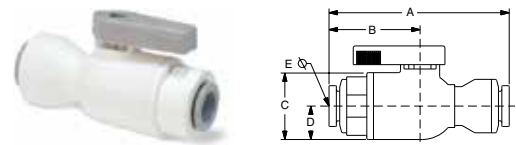
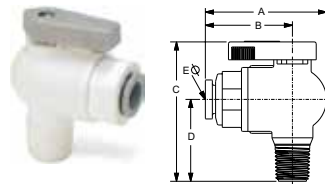

VME - Valve Male Elbow

PART NO.	NOM. TUBE O.D.	NPTF THREAD SIZE	A	B	C	D	ØE THRU HOLE MIN.
LFPP4VME2	1/4	1/8	1.74	1.21	2.00	1.10	.19
LFPP4VME4	1/4	1/4	1.74	1.21	2.18	1.28	.19
LFPP4VME6	1/4	3/8	1.74	1.21	2.18	1.28	.19
LFPP4VME8	1/4	1/2	1.74	1.21	2.37	1.47	.19
LFPP6VME2	3/8	1/8	1.85	1.32	2.00	1.10	.25
LFPP6VME4	3/8	1/4	1.85	1.32	2.18	1.28	.25
LFPP6VME6	3/8	3/8	1.85	1.32	2.18	1.28	.25
LFPP6VME8	3/8	1/2	1.85	1.32	2.37	1.47	.25
LFPP8VME8	1/2	1/2	2.73	1.74	2.38	1.47	.37

VUC - Valve Union Connector Metric

PART NO.	1 TUBE SIZE MM	2 TUBE SIZE MM	A MM	B MM	C MM	D MM	ØE THRU HOLE MIN. MM
LFPP6MVUC6M	6	6	.57	.27	.36	.13	.19
LFPP8MVUC8M	8	8	.60	.27	.36	.13	.25
LFPP10MVUC10M	10	10	.70	.33	.36	.13	.33
LFPP12MVUC12M	12	12	.88	.43	.36	.13	.37

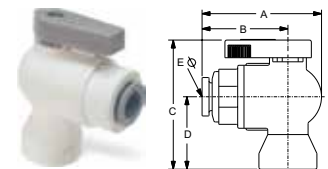
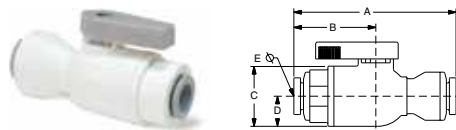

VUC - Valve Union Connector

PART NO.	1 TUBE SIZE	2 TUBE SIZE	A	B	C	D	ØE THRU HOLE MIN.
LFPP4VUC4	1/4	1/4	2.55	1.22	1.0	.5	.19
LFPP4VUC6	1/4	3/8	2.57	1.30	1.0	.5	.19
LFPP6VUC6	3/8	3/8	2.67	1.32	1.4	.5	.25
LFPP8VUC8	1/2	1/2	3.50	1.74	1.4	.5	.37

VFE - Valve Female Elbow

PART NO.	NOM. TUBE O.D.	NPTF THREAD SIZE	A	B	C	D	ØE THRU HOLE MIN.
LFPP4VFE2	1/4	1/8	1.74	1.21	1.82	.92	.19
LFPP4VFE4	1/4	1/4	1.74	1.21	2.05	1.15	.19
LFPP4VFE6	1/4	3/8	1.74	1.21	2.18	1.28	.19
LFPP6VFE2	3/8	1/8	1.85	1.32	1.82	.92	.25
LFPP6VFE4	3/8	1/4	1.85	1.32	2.05	1.15	.25
LFPP6VFE6	3/8	3/8	1.85	1.32	2.18	1.28	.25

NOTE: PPL refers to Polypropylene. FCB refers to Fluorocarbon.

WARNING These products can expose you to chemicals including CARBON BLACK, or LEAD, which are known to the state of California to cause cancer, and LEAD which is known to cause birth defects or other reproductive harm. For more information go to www.P65Warnings.ca.gov.

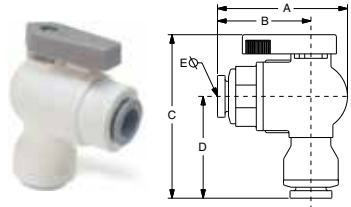

VEU - Valve Elbow Union

PART NO.	1 TUBE SIZE	2 TUBE SIZE	A	B	C	D	ØE THRU HOLE MIN.
LFPP4VEU4	1/4	1/4	1.75	1.22	2.33	1.42	.19
LFPP4VEU6	1/4	3/8	1.75	1.22	2.33	1.42	.11
LFPP6VEU4	3/8	1/4	1.83	1.30	2.32	1.40	.19
LFPP6VEU6	3/8	3/8	1.85	1.32	2.34	1.44	.25

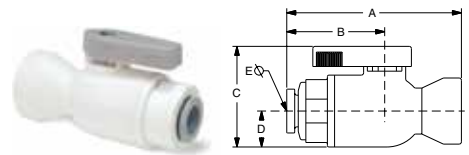

VFC - Valve Female Connector

PART NO.	NOM. TUBE O.D.	NPTF THREAD SIZE	A	B	C	D	ØE THRU HOLE MIN.
LFPP4VFC2	1/4	1/8	2.04	1.21	1.4	.5	.19
LFPP4VFC4	1/4	1/4	2.27	1.21	1.4	.5	.19
LFPP4VFC6	1/4	3/8	2.40	1.21	1.4	.5	.19
LFPP6VFC2	3/8	1/8	2.15	1.32	1.4	.5	.25
LFPP6VFC4	3/8	1/4	2.38	1.32	1.4	.5	.25
LFPP6VFC6	3/8	3/8	2.51	1.32	1.4	.5	.25

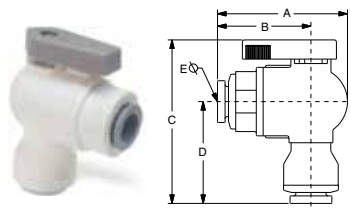

VEU - Valve Elbow Union Metric

PART NO.	1 TUBE SIZE MM	2 TUBE SIZE MM	A MM	B MM	C MM	D MM	ØE THRU HOLE MIN. MM
LFPP6MVEU6M	6	6	.41	.27	.55	.31	.19
LFPP8MVEU8M	8	8	.41	.28	.56	.33	.25
LFPP10MVEU10M	10	10	.48	.33	.61	.38	.33

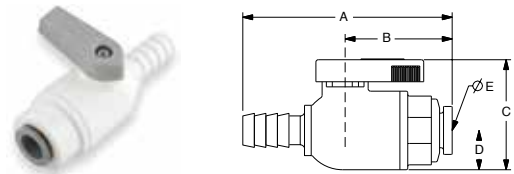

VUCPB - Valve Union Connector Barbed x Tube

PART NO.	HOSE ID	TUBE OD	OD	A	B	C	D	ØE THRU HOLE MIN.
LFPP4VUCPB4	1/4	1/4	.31	2.40	1.08	1.42	.50	.15
LFPP6VUCPB6	3/8	3/8	.43	2.63	1.32	1.42	.50	.19

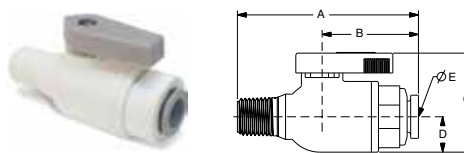

VMC - Valve Male Connector

PART NO.	NOM. TUBE O.D.	NPTF THREAD SIZE	A	B	C	D	ØE THRU HOLE MIN.
LFPP4VMC2	1/4	1/8	2.22	1.21	1.4	.5	.19
LFPP4VMC4	1/4	1/4	2.40	1.21	1.4	.5	.19
LFPP4VMC6	1/4	3/8	2.40	1.21	1.4	.5	.19
LFPP4VMC8	1/4	1/2	2.59	1.21	1.4	.5	.19
LFPP6VMC2	3/8	1/8	2.33	1.32	1.4	.5	.25
LFPP6VMC4	3/8	1/4	2.51	1.32	1.4	.5	.25
LFPP6VMC6	3/8	3/8	2.51	1.32	1.4	.5	.25
LFPP6VMC8	3/8	1/2	2.70	1.32	1.4	.5	.25
LFPP8VMC8	1/2	1/2	3.14	1.74	1.4	.5	.37

NOTE: PPL refers to Polypropylene. FCB refers to Fluorocarbon.

WARNING These products can expose you to chemicals including CARBON BLACK, or LEAD, which are known to the state of California to cause cancer, and LEAD which is known to cause birth defects or other reproductive harm. For more information go to www.P65Warnings.ca.gov.



VAS - Valve Angle Stop

PART NO.	TUBE O.D.	MALE THD.	FEMALE THD.	A	B	C	D	E	F
LFPP4VAS6	1/4	3/8	3/8	1.95	1.24	2.17	1.11	1.41	.91
LFPP4VAS8	1/4	3/8	1/2	1.95	1.24	2.40	1.11	1.41	.91
LFPP6VAS6	3/8	3/8	3/8	2.06	1.35	2.17	1.11	1.41	.91
LFPP6VAS8	3/8	3/8	1/2	2.06	1.35	2.40	1.11	1.41	.91

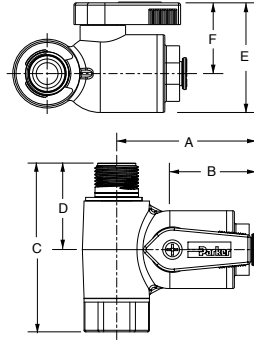

VAS Assembly Instructions:

- Shut off water supply at brass/chrome supply valve. Disconnect riser from brass/chrome supply valve. Ensure that the sealing gasket is fully seated into the Angle Stop Valve female thread.
- Install Angle Stop Adapter Valve on supply valve. Connect the riser to the Angle Stop Adapter Valve.
- Fully insert tubing into the side of the valve. Open valves and check for leaks.

Do not use thread sealant. Do not over tighten.

WARNING These products can expose you to chemicals including CARBON BLACK, or LEAD, which are known to the state of California to cause cancer, and LEAD which is known to cause birth defects or other reproductive harm. For more information go to www.P65Warnings.ca.gov.



TrueSeal™ Fittings

Parker's TrueSeal Fittings are lightweight, field attachable and connect to tubing without the use of tools. These all plastic push-to-connect fittings are manufactured from FDA compliant materials.

Product Features:

- Available in Acetal, Polypropylene and Kynar materials
- Acetal and Polypropylene (EPDM seals)
- Kynar (Fluorocarbon (FKM) seals) please contact FSCapps@parker.com directly for more information
- Gripping ring with stainless steel bite edge or with an engineered thermoplastic bite edge
- FDA compliant, NSF/ANSI 51
- Gray acetal NSF/ANSI 61

Markets:

- Food
- Potable Water
- Chemical
- Filtration

Applications:

- Air
- Water
- Soft Drinks
- Beer
- Wine
- Dyes

Specifications:

Pressure Range

Acetal and Kynar:	1/4", 5/16", 3/8" Vacuum to 300 PSI (20.7 bar)
	1/2" Vacuum to 250 PSI (17.2 bar)
Polypropylene:	1/4", 3/8", 1/2" Vacuum to 150 PSI (10.3 bar)

*Vacuum rating to 28 inches of Hg at room temperature

Temperature Range

Acetal:	-20° to +180° F (-28.9° to +82.2° C)
Polypropylene:	0° to +225° F (-17.8° to +107.2° C)
Kynar:	0° to +275° F (-17.8° to +135° C)

Compatible Tubing:

- Polyethylene
- Polypropylene**
- Nylon**
- Vinyl
- Fluoropolymer**
- Polyurethane+
- *Kynar®

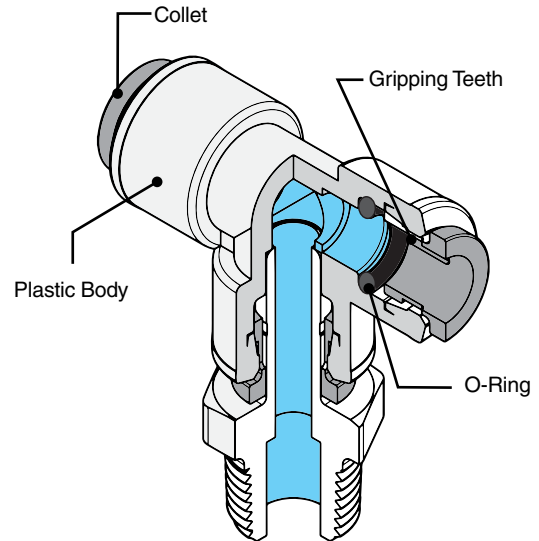

Assembly Instructions

1. Cut tubing square and clean. (Use a Parker plastic tube cutter, Part No. PTC.)
2. Mark from end of tube length of insertion (see table below).
3. Push tube into the fitting until it bottoms out.
4. To remove, depress collet and pull tubing out.

TUBE SIZE	O.D. TOLERANCE	INSERTION DEPTH
5/32	±.005	9/16
1/4	±.005	11/16
5/16	±.005	13/16
3/8	±.005	3/4
1/2	±.005	7/8

* Registered trademark of The Arkema Group.
 ** Metal gripper required (-MG suffix).
 + Tube Support required.

WARNING These products can expose you to chemicals including CARBON BLACK, which is known to the state of California to cause cancer. For more information go to www.P65Warnings.ca.gov.



Tube to NPTF	MC Male Connector  p. C19	MES Male Elbow Swivel  p. C20	MRS Male Run Tee Swivel  p. C20	MTS Male Branch Tee Swivel  p. C20	TMC Male Standpipe  p. C21	ME Male Elbow  p. C23
	FA Faucet Adapter  p. C21	Tube to Female NPTF	FC Female Connector  p. C21	FE Female Elbow  p. C22	Tube to Straight Thread	ST Straight Thread  p. C23
FF 45° Female Flare  p. C21	EU Union Elbow  p. C19		TU Union Tee  p. C19	WY Union Y  p. C19		UC Union  p. C20
CU Cross  p. C21	Bulkhead Union	BU Bulkhead Union  p. C22	Plug-ins	TEU Tube Elbow Union  p. C22	RD Tube Reducer  p. C22	
VC Check Valve  p. C25		MCVC Kynar Check Valve  p. C25		Auxiliary Components	CAP Cap  p. C22	TCB Barbed Connector  p. C23
TPL Plug  p. C23	TFA Faucet Adapter  p. C21	TAF Faucet Adapter  p. C21	SC Safety Clip  p. C28		TS Tube Support  p. C28	AQRT Release Tool  p. C28
Ball Valves	VME Male Elbow  p. C26	VFE Female Elbow  p. C26	VUC Union Connector  p. C27	VEU Elbow Union  p. C27	VMC Male Connector  p. C27	VFC Female Connector  p. C27
	VTEU Elbow Union  p. C27					

WARNING These products can expose you to chemicals including CARBON BLACK, which is known to the state of California to cause cancer. For more information go to www.P65Warnings.ca.gov.

MC - Male Connector

Tube-to-Pipe

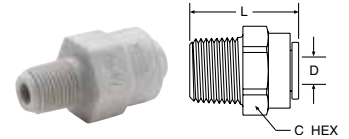

GRAY ACETAL EPDM SEAL	BLACK PPL EPDM SEAL	WHITE PPL EPDM SEAL	NATURAL KYNAR FKM SEAL	NOM TUBE O. D.	NPTF THREAD SIZE	C HEX	L OVERALL LENGTH	FLOW DIA. D
A4MC2-MG	PPB4MC2-MG	PP4MC2	F4MC2	1/4	1/8	11/16	1.28	.175
A4MC4-MG	PPB4MC4-MG	PP4MC4	F4MC4	1/4	1/4	11/16	1.14	.175
A4MC6-MG	PPB4MC6-MG	PP4MC6	F4MC6	1/4	3/8	11/16	1.18	.175
A5MC2-MG			F5MC2	5/16	1/8	13/16	1.46	.175
A5MC4-MG			F5MC4	5/16	1/4	13/16	1.41	.188
A5MC6-MG				5/16	3/8	13/16	1.27	.188
A6MC2-MG			F6MC2	3/8	1/8	13/16	1.46	.175
A6MC4-MG	PPB6MC4-MG	PP6MC4	F6MC4	3/8	1/4	13/16	1.41	.250
A6MC6-MG	PPB6MC6-MG	PP6MC6	F6MC6	3/8	3/8	13/16	1.27	.250
A6MC8-MG			F6MC8	3/8	1/2	15/16	1.45	.250
A8MC6-MG	PPB8MC6-MG	PP8MC6	F8MC6	1/2	3/8	15/16	1.65	.360
A8MC8-MG	PPB8MC8-MG	PP8MC8	F8MC8	1/2	1/2	15/16	1.46	.375

For nonstandard plastic collet, remove -MG suffix.

EU - Elbow Union

Tube-to-Tube

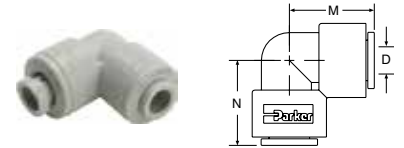

GRAY ACETAL EPDM SEAL	BLACK PPL EPDM SEAL	WHITE PPL EPDM SEAL	NATURAL KYNAR FKM SEAL	NOM. TUBE O. D.	M	N	FLOW DIA. D
A4EU4-MG	PPB4EU4-MG	PP4EU4	F4EU4	1/4	.87	.87	.175
A5EU4-MG				5/16-1/4	1.052	.90	.175
A5EU5-MG			F5EU5	5/16	1.02	1.02	.188
A6EU4-MG		PP6EU4	F6EU4	3/8-1/4	1.02	.90	.212
A6EU5-MG				3/8-5/16	1.02	1.02	.175
A6EU6-MG	PPB6EU6-MG	PP6EU6	F6EU6	3/8	1.02	1.02	.250
A8EU6-MG	PPB8EU6-MG			1/2-3/8	1.20	1.20	.250
A8EU8-MG	PPB8EU8-MG	PP8EU8	F8EU8	1/2	1.20	1.20	.375

For nonstandard plastic collet, remove -MG suffix.

TU - Tee Union

Tube-to-Tube

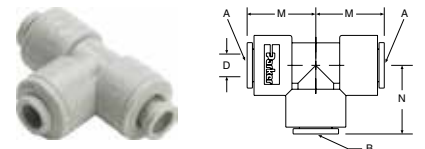

GRAY ACETAL EPDM SEAL	BLACK PPL EPDM SEAL	WHITE PPL EPDM SEAL	NATURAL KYNAR FKM SEAL	NOM. TUBE O. D.		M	N	FLOW DIA. D
				TUBE A RUN	TUBE B STEM			
A4TU4-MG	PPB4TU4-MG	PP4TU4	F4TU4	1/4	1/4	.81	.85	.175
A5TU5-MG			F5TU5	5/16	5/16	1.02	1.02	.188
A6TU4-MG	PPB6TU4-MG	PP6TU4	F6TU4	3/8	1/4	1.02	1.03	.175
A6TU6-MG	PPB6TU6-MG	PP6TU6	F6TU6	3/8	3/8	1.02	1.02	.290
A8TU8-MG	PPB8TU8-MG	PP8TU8	F8TU8	1/2	1/2	1.20	1.20	.375

For nonstandard plastic collet, remove -MG suffix.

WARNING These products can expose you to chemicals including CARBON BLACK, which is known to the state of California to cause cancer. For more information go to www.P65Warnings.ca.gov.

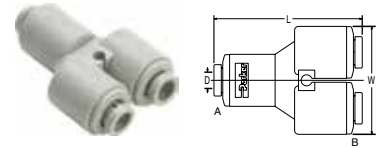

WY - "Y" Union

Tube-to-Tube

GRAY ACETAL EPDM SEAL	WHITE PPL EPDM SEAL	NATURAL KYNAR FKM SEAL	NOM. TUBE O.D.		L	W	FLOW DIA. D
			INLET TUBE A RUN	OUTLET TUBE B STEM			
A5WY5-MG			5/16	5/16	2.250	1.75	0.190
A6WY4-MG			3/8	1/4	2.100	1.43	0.190
A6WY5-MG			3/8	5/16	2.200	1.75	0.190
A6WY6-MG			3/8	3/8	2.175	1.75	0.250

MES - Male Elbow Swivel

Tube-to-Pipe



GRAY ACETAL EPDM SEAL	BLACK PPL EPDM SEAL	WHITE PPL EPDM SEAL	NATURAL KYNAR FKM SEAL	NOM. TUBE O.D.	NPTF THREAD SIZE	C HEX	M	N	FLOW DIA. D
A4MES2-MG	PPB4MES2-MG	PP4MES2	F4MES2	1/4	1/8	9/16	.87	1.60	.175
A4MES4-MG	PPB4MES4-MG	PP4MES4	F4MES4	1/4	1/4	11/16	.87	1.71	.175
A4MES6-MG		PP4MES6	F4MES6	1/4	3/8	13/16	.90	1.91	.212
A5MES2-MG				5/16	1/8	9/16	1.02	1.78	.188
A5MES4-MG				5/16	1/4	11/16	1.02	1.90	.188
A5MES6-MG				5/16	3/8	13/16	1.02	1.90	.188
A6MES2-MG			F6MES2	3/8	1/8	9/16	1.02	1.65	.175
A6MES4-MG	PPB6MES4-MG	PP6MES4	F6MES4	3/8	1/4	13/16	1.02	1.90	.250
A6MES6-MG	PPB6MES6-MG	PP6MES6	F6MES6	3/8	3/8	13/16	1.02	1.90	.250
A8MES4-MG				1/2	1/4	13/16	1.20	2.10	.240
A8MES6-MG		PP8MES6		1/2	3/8	13/16	1.20	2.10	.375
A8MES8-MG		PP8MES8		1/2	1/2	1	1.20	2.32	.375

* Part consists of elbow union and tube stem adaptor.
 Note: Assemblies with metal gripper collets are permanent. Assemblies with plastic collets can be taken apart.

MRS - Male Run Tee Swivel

Tube-to-Pipe

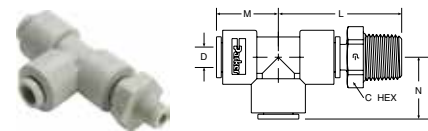

GRAY ACETAL EPDM SEAL	BLACK PPL EPDM SEAL	WHITE PPL EPDM SEAL	NATURAL KYNAR FKM SEAL	NOM. TUBE O.D.	NPTF THREAD SIZE	C HEX	L	M	N	D THRU HOLE MIN.
A4MRS2-MG	PPB4MRS2	PP4MRS2	F4MRS2	1/4	1/8	9/16	1.55	.81	0.85	.175
A4MRS4-MG	PPB4MRS4-MG	PP4MRS4	F4MRS4	1/4	1/4	11/16	1.67	.81	0.85	.175
A5MRS2-MG				5/16	1/8	9/16	1.78	1.02	1.02	.188
A5MRS4-MG				5/16	1/4	11/16	1.90	1.02	1.02	.188
A5MRS6-MG				5/16	3/8	13/16	1.90	1.02	1.02	.188
A6MRS4-MG	PPB6MRS4-MG	PP6MRS4	F6MRS4	3/8	1/4	13/16	1.90	1.02	1.02	.250
A6MRS6-MG	PPB6MRS6-MG	PP6MRS6	F6MRS6	3/8	3/8	13/16	1.90	1.02	1.02	.250
A8MRS4-MG				1/2	1/4	13/16	2.10	1.20	1.20	.240
A8MRS6-MG		PP8MRS6		1/2	3/8	13/16	2.10	1.20	1.20	.375
A8MRS8-MG		PP8MRS8		1/2	1/2	1	2.32	1.20	1.20	.375

*Part consists of tee union and tube stem adaptor.
 Note: Assemblies with metal gripper collets are permanent. Assemblies with plastic collets can be taken apart.

WARNING These products can expose you to chemicals including CARBON BLACK, which is known to the state of California to cause cancer. For more information go to www.P65Warnings.ca.gov.

MTS - Male Tee Swivel

Tube-to-Pipe

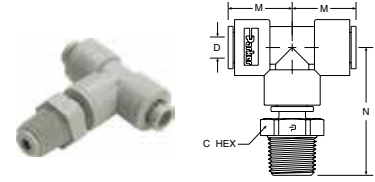

GRAY ACETAL EPDM SEAL	BLACK PPL EPDM SEAL	WHITE PPL EPDM SEAL	NATURAL KYNAR FKM SEAL	NOM. TUBE O.D.	NPTF THREAD SIZE	C HEX	M	N	FLOW DIA. D
A4MTS2-MG	PPB4MTS2	PP4MTS2	F4MTS2	1/4	1/8	9/16	.81	1.60	.175
A4MTS4-MG	PPB4MTS4-MG	PP4MTS4	F4MTS4	1/4	1/4	11/16	.81	1.71	.175
A5MTS2-MG				5/16	1/8	9/16	1.02	1.78	.188
A5MTS4-MG				5/16	1/4	11/16	1.02	1.90	.188
A5MTS6-MG				5/16	3/8	13/16	1.02	1.90	.188
A6MTS2-MG			F6MTS2	3/8	1/8	9/16	1.02	1.75	.175
A6MTS4-MG	PPB6MTS4-MG	PP6MTS4	F6MTS4	3/8	1/4	13/16	1.02	1.90	.250
A6MTS6-MG	PPB6MTS6-MG	PP6MTS6	F6MTS6	3/8	3/8	13/16	1.02	1.90	.250
A8MTS4-MG				1/2	1/4	13/16	1.20	2.10	.240
A8MTS6-MG		PP8MTS6		1/2	3/8	13/16	1.20	2.10	.375
A8MTS8-MG		PP8MTS8		1/2	1/2	1	1.20	2.32	.375

* Part consists of tee union and tube stem adaptor.

Note: Assemblies with metal gripper collets are permanent. Assemblies with plastic collets can be taken apart.

UC - Union Connector

Tube-to-Tube

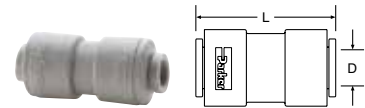

GRAY ACETAL EPDM SEAL	BLACK PPL EPDM SEAL	WHITE PPL EPDM SEAL	NATURAL KYNAR FKM SEAL	NOM. TUBE O.D.	L OVERALL LENGTH	FLOW DIA. D
A4UC4-MG	PPB4UC4-MG	PP4UC4	F4UC4	1/4	1.49	.175
A5UC4-MG				5/16-1/4	1.70	.175
A5UC5-MG			F5UC5	5/16	1.70	.188
A6UC4-MG	PPB6UC4-MG	PP6UC4	F6UC4	3/8-1/4	1.70	.175
A6UC5-MG				3/8-5/16	1.70	.188
A6UC6-MG	PPB6UC6-MG	PP6UC6	F6UC6	3/8	1.70	.250
A8UC5-MG				1/2-5/16	1.90	.188
A8UC6-MG	PPB8UC6-MG	PP8UC6		1/2-3/8	1.90	.250
A8UC8-MG	PPB8UC8-MG	PP8UC8	F8UC8	1/2	1.91	.375

For nonstandard plastic collet, remove -MG suffix.

FA - Faucet Adapter

Tube-to-Faucet

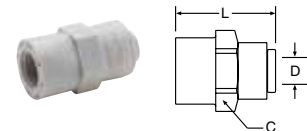

GRAY ACETAL EPDM SEAL	BLACK PPL EPDM SEAL	WHITE PPL EPDM SEAL	NATURAL KYNAR FKM SEAL	NOM. TUBE O.D.	UNS-2B THREAD SIZE	C HEX	L OVERALL LENGTH	FLOW DIA. D
A4FA7-MG	PPB4FA7-MG	PP4FA7	F4FA7	1/4	7/16-24	23/32	1.32	.190
A5FA7-MG				5/16	7/16-24	13/16	1.41	.190
A6FA7-MG	PPB6FA7-MG	PP6FA7	F6FA7	3/8	7/16-24	13/16	1.41	.190

For nonstandard plastic collet, remove -MG suffix.

WARNING These products can expose you to chemicals including CARBON BLACK, which is known to the state of California to cause cancer. For more information go to www.P65Warnings.ca.gov.

FC - Female Connector

Tube-to-Pipe

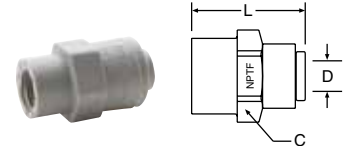

GRAY ACETAL EPDM SEAL	BLACK PPL EPDM SEAL	WHITE PPL EPDM SEAL	NATURAL KYNAR FKM SEAL	NOM. TUBE O.D.	NPTF THREAD SIZE	C HEX	L OVERALL LENGTH	FLOW DIA. D
A4FC2-MG	PPB4FC2-MG	PP4FC2	F4FC2	1/4	1/8	11/16	1.20	.175
A4FC4-MG	PPB4FC4-MG	PP4FC4	F4FC4	1/4	1/4	23/32	1.32	.175
A5FC4-MG			F5FC4	5/16	1/4	13/16	1.41	.188
A5FC6-MG				5/16	3/8	1	1.50	.188
A6FC4-MG	PPB6FC4-MG	PP6FC4	F6FC4	3/8	1/4	13/16	1.41	.250
A6FC6-MG	PPB6FC6-MG	PP6FC6	F6FC6	3/8	3/8	1	1.50	.250
A6FC8-MG				3/8	1/2	1-1/8	1.52	.250
A8FC6-MG		PP8FC6	F8FC6	1/2	3/8	1-1/8	1.60	.375
A8FC8-MG		PP8FC8	F8FC8	1/2	1/2	1-1/8	1.75	.375

For nonstandard plastic collet, remove -MG suffix.

TMC - Tube Stem Adapter

Tube Stem-to-Pipe

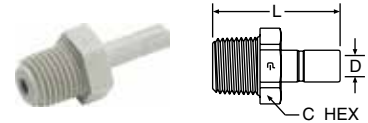

GRAY ACETAL EPDM SEAL	BLACK PPL EPDM SEAL	WHITE PPL EPDM SEAL	NATURAL KYNAR FKM SEAL	NOM. TUBE O.D.	NPTF THREAD SIZE	C HEX	L OVERALL LENGTH	FLOW DIA. D
A4TMC2	PPB4TMC2	PP4TMC2	F4TMC2	1/4	1/8	9/16	1.44	.175
A4TMC4	PPB4TMC4	PP4TMC4	F4TMC4	1/4	1/4	11/16	1.56	.175
A5TMC2				5/16	1/8	9/16	1.5	.188
A5TMC4			F5TMC4	5/16	1/4	11/16	1.67	.188
A5TMC6				5/16	3/8	13/16	1.67	.188
A6TMC4	PPB6TMC4	PP6TMC4	F6TMC4	3/8	1/4	13/16	1.70	.250
A6TMC6	PPB6TMC6	PP6TMC6	F6TMC6	3/8	3/8	13/16	1.70	.250
A8TMC4				1/2	1/4	13/16	1.82	.240
A8TMC6		PP8TMC6		1/2	3/8	13/16	1.82	.375
A8TMC8		PP8TMC8		1/2	1/2	1	2.04	.375

BU - Bulkhead Union

Tube-to-Tube

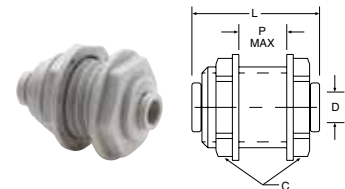

GRAY ACETAL EPDM SEAL	BLACK PPL EPDM SEAL	WHITE PPL EPDM SEAL	NATURAL KYNAR FKM SEAL	NOM. TUBE O.D.	C1 HEX	C2 HEX	L OVERALL LENGTH	P MAX. WALL THICKNESS	FLOW DIA. D	BKHD HOLE DRILL SIZE
A4BU4-MG	PPB4BU4-MG	PP4BU4	F4BU4	1/4	15/16	15/16	1.50	.50	.175	7/8
A5BU5-MG			F5BU5	5/16	1-1/16	1-1/16	1.75	.62	.188	1
A6BU4-MG	PPB6BU4-MG	PP6BU4		3/8-1/4	1-1/16	1-1/16	1.75	.62	.175	1
A6BU6-MG	PPB6BU6-MG	PP6BU6	F6BU6	3/8	1-1/16	1-1/16	1.75	.62	.250	1
A8BU8-MG			F8BU8	1/2	1-1/4	1-1/4	2.04	.70	.375	1-1/8

For nonstandard plastic collet, remove -MG suffix.

WARNING These products can expose you to chemicals including CARBON BLACK, which is known to the state of California to cause cancer. For more information go to www.P65Warnings.ca.gov.

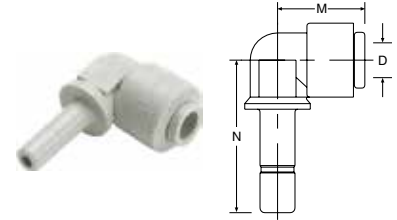

TEU - Tube Elbow Union

Tube-to-Tube Stem

GRAY ACETAL EPDM SEAL	BLACK PPL EPDM SEAL	WHITE PPL EPDM SEAL	NATURAL KYNAR FKM SEAL	NOM. TUBE O.D.	TUBE STEM O.D.	M	N	FLOW DIA. D
A4TEU4-MG	PPB4TEU4-MG	PP4TEU4	F4TEU4	1/4	1/4	.84	1.21	.125
A4TEU6-MG			F4TEU6	1/4	3/8	.84	1.35	.125
A5TEU5-MG			F5TEU5	5/16	5/16	1.03	1.40	.188
A6TEU4-MG			F6TEU4	3/8	1/4	1.03	1.29	.125
A6TEU6-MG	PPB6TEU6	PP6TEU6	F6TEU6	3/8	3/8	1.03	1.64	.250
A8TEU8-MG	PPB8TEU8-MG	PP8TEU8	F8TEU8	1/2	1/2	1.21	1.64	.380

For nonstandard plastic collet, remove -MG suffix.

RD - Tube Reducer

Tube-to-Tube Stem

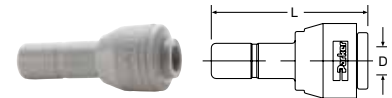

GRAY ACETAL EPDM SEAL	BLACK PPL EPDM SEAL	WHITE PPL EPDM SEAL	NATURAL KYNAR FKM SEAL	NOM. TUBE O.D.	TUBE STEM O.D.	L	FLOW DIA. D
A4RD5-MG		PP4RD5		1/4	5/16	1.62	.18
A4RD6-MG	PPB4RD6-MG	PP4RD6		1/4	3/8	1.62	.18
A5RD6-MG				5/16	3/8	1.78	.25
A5RD8-MG				5/16	1/2	1.90	.25
A6RD8-MG				3/8	1/2	1.90	.25

For nonstandard plastic collet, remove -MG suffix.

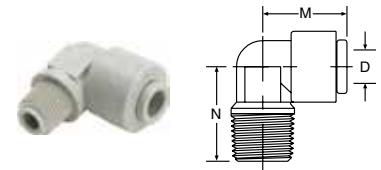

ME - Male Elbow

Tube-to-Pipe

GRAY ACETAL EPDM SEAL	BLACK PPL EPDM SEAL	WHITE PPL EPDM SEAL	NATURAL KYNAR FKM SEAL	NOM. TUBE O.D.	NPTF THREAD SIZE	M	N	FLOW DIA. D
A4ME2-MG	PPB4ME2-MG	PP4ME2	F4ME2	1/4	1/8	.84	.94	.175
A4ME4-MG	PPB4ME4-MG	PP4ME4	F4ME4	1/4	1/4	.84	.94	.175
A4ME6-MG	PPB4ME6-MG	PP4ME6	F4ME6	1/4	3/8	.84	1.04	.175
A5ME4-MG			F5ME4	5/16	1/4	1.03	1.08	.175
A5ME6-MG				5/16	3/8	1.03	1.06	.188
A6ME4-MG		PP6ME4	F6ME4	3/8	1/4	1.03	1.08	.250
A6ME6-MG	PPB6ME6-MG	PP6ME6	F6ME6	3/8	3/8	1.03	1.06	.250

For nonstandard plastic collet, remove -MG suffix.

WARNING These products can expose you to chemicals including CARBON BLACK, which is known to the state of California to cause cancer. For more information go to www.P65Warnings.ca.gov.

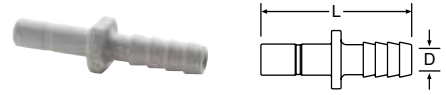

TCB - Tube-to-Barb Connector

GRAY ACETAL	BLACK PPL EPDM SEAL	WHITE POLYPROPYLENE	NATURAL KYNAR	TUBE STEM O.D.	TUBE I.D.	L OVERALL LENGTH	FLOW DIA. D
A4TCB4		PP4TCB4	F4TCB4	1/4	1/4	1.67	.140
A6TCB4			F6TCB4	3/8	1/4	1.82	.140
A6TCB6	PPB6TCB6-MG	PP6TCB6	F6TCB6	3/8	3/8	1.98	.250
A8TCB6				1/2	3/8	2.10	.250
A8TCB8			F8TCB8	1/2	1/2	2.10	.375

CU - Cross Union

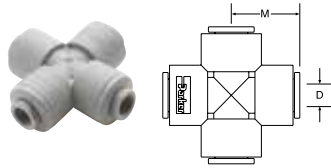

Tube-to-Tube

GRAY ACETAL EPDM SEAL	WHITE PPL EPDM SEAL	NATURAL KYNAR FCB SEAL	NOM. TUBE O.D.	M	FLOW DIA. D
A4CU4-MG			1/4	.91	.175
A6CU6-MG			3/8	1.08	.250

For nonstandard plastic collet, remove -MG suffix.

TAF - Tube Faucet Adapter

(Male Thread)

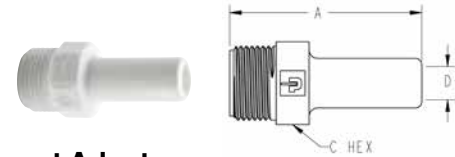

WHITE ACETAL	TUBE STEM O.D.	THREAD SIZE	A	C HEX	D MIN.
AW6TAF7-MG	3/8	7/16-24	1.41	.50	.22
AW6TAF8-MG	3/8	1/2-14 NPSM	1.65	.88	.22
AW6TAF9-MG	3/8	9/16-24	1.45	.63	.22

FF - 45° Female Flare

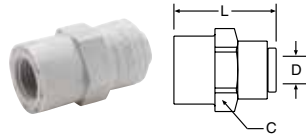

Tube-to-Flare

GRAY ACETAL EPDM SEAL	WHITE PPL EPDM SEAL	NATURAL KYNAR FKM SEAL	NOM. TUBE O.D.	UNF-2B THREAD SIZE	C HEX	L OVERALL LENGTH	FLOW DIA. D
A4FF4-MG	PP4FF4	F4FF4	1/4	7/16-20	23/32	1.32	.190
A6FF4-MG		F6FF4	3/8	7/16-20	13/16	1.41	.190
A6FF6-MG	PP6FF6	F6FF6	3/8	5/8-18	1	1.50	.250

For nonstandard plastic collet, remove -MG suffix.

ST - Straight Thread

Tube-to-Male O-Ring Boss

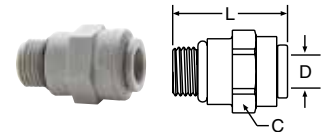

GRAY ACETAL EPDM SEAL	WHITE PPL EPDM SEAL	NATURAL KYNAR FKM SEAL	NOM. TUBE O.D.	UNF-2B THD SIZE	C HEX	L OVERALL LENGTH	FLOW DIA. D
A6ST9-MG		F6ST9 (+)	3/8	9/16-18	13/16	1.39	.250

For nonstandard plastic collet, remove -MG suffix.

TFA - Tube Faucet Adapter

(Female Thread)

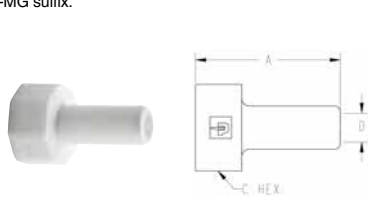

WHITE ACETAL	TUBE STEM O.D.	THREAD SIZE	A	C HEX	D MIN.
AW6TFA7-MG	3/8	7/16-24	1.25	.69	.17
AW6TFA8-MG	3/8	1/2-14 NPSM	1.45	1.06	.22
AW6TFA9-MG	3/8	9/16-24	1.25	.75	.22

CAP - Tube Cap



GRAY ACETAL EPDM SEAL	WHITE PPL EPDM SEAL	NATURAL KYNAR FKM SEAL	NOM. TUBE O.D.	L OVERALL LENGTH
A4CAP-MG	PP4CAP	F4CAP	1/4	.77
A6CAP-MG	PP6CAP		3/8	0.88

For nonstandard plastic collet, remove -MG suffix.

WARNING These products can expose you to chemicals including CARBON BLACK, which is known to the state of California to cause cancer. For more information go to www.P65Warnings.ca.gov.

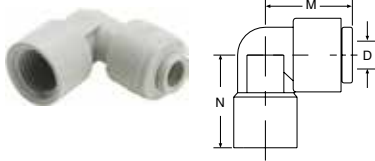

FE - Female Elbow

Tube-to-Pipe

GRAY ACETAL EPDM SEAL	WHITE PPL EPDM SEAL	NATURAL KYNAR FKM SEAL	NOM. TUBE O.D.	NPTF THREAD SIZE	M	N	FLOW DIA. D
A4FE4-MG			1/4	1/4	.84	1.00	.18
A6FE4-MG			3/8	1/4	1.03	1.00	.25
A6FE6-MG			3/8	3/8	1.03	1.00	.25

For nonstandard plastic collet, remove -MG suffix.

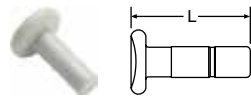

TPL - Plug

GRAY ACETAL	BLACK PPL	WHITE PPL	NATURAL KYNAR	FITTING SIZE	L OVERALL LENGTH
A4TPL	PPB4TPL	PP4TPL	F4TPL	1/4	0.88
A6TPL	PPB6TPL-MG	PP6TPL	F6TPL	3/8	1.45
A8TPL	PPB8TPL	PP8TPL		1/2	1.50



TEB - Tube Elbow Barb Connector

GRAY ACETAL	WHITE POLYPROPYLENE	NATURAL KYNAR	TUBE STEM O.D.	TUBE I.D.	M	N	FLOW DIA. D
A4TEB4	PP4TEB4	F4TEB4	1/4	1/4	.89	1.00	.140
A6TEB4	PP6TEB4	F6TEB4	3/8	1/4	1.335	1.055	.375
A6TEB6	PP6TEB6	F6TEB6	3/8	3/8	1.34	1.21	.250
A8TEB8			1/2	1/2	1.30	1.30	.390

WARNING These products can expose you to chemicals including CARBON BLACK, which is known to the state of California to cause cancer. For more information go to www.P65Warnings.ca.gov.



TSC - Cartridge Insert

PART NUMBER WITH EPDM SEAL	NOM. TUBE O.D.	A* DIAMETER ±002	B DIAMETER ±003	C DIAMETER ±003	D DIAMETER MAXIMUM	E DEPTH ±002	F DEPTH ±002	G DEPTH ±002	H* CENTERLINE OF PORTS MINIMUM
ATSC4-MG	1/4	.528	.421	.260	.19	.230	.435	.600	.670
ATSC6-MG	3/8	.632	.545	.385	.31	.280	.455	.705	.790
ATSC8-MG	1/2	.774	.668	.510	.41	.315	.510	.810	1.250

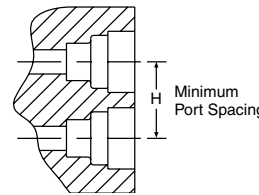
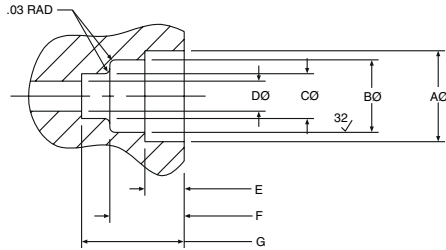

Parker TrueSeal™ Cartridge Inserts:

Allow you to machine or mold a tube connection into your equipment or components. By using cartridge inserts, you will reduce your material and assembly costs, reduce potential leak paths, and give your equipment a new, clean profile by eliminating the need for threaded connections. TSC Cartridge Inserts consist of 1 o-ring, 1 cartridge, and 1 collet.

*Cartridge inserts are rated at 150 PSI in ports dimensioned as above and having Noryl as the receiving material. Other materials may have different ratings and require different port dimensions. Consult the Fluid System Connectors Division when using polypropylene, unfilled polypropylene, ABS or Nylon.

Assembly Instructions:

1. Machine or mold the receiving orifice as per the above dimensions.
2. Place the cartridge insert squarely onto the prepared port opening making sure that the barbs of the cartridge are going into the hole and the lettering on the face of the cartridge is visible.
3. Using a rubber mallet or press, insert the cartridge into the first gland orifice until its face is flush with the top surface of the port.
4. Insert the o-ring into the cartridge and seat it evenly into the second gland orifice.
5. Insert the collet into the cartridge opening.
6. Insert tubing.

WARNING These products can expose you to chemicals including CARBON BLACK, which is known to the state of California to cause cancer. For more information go to www.P65Warnings.ca.gov.

TrueSeal Check Valves

Push-to-Connect check valves that ensures protection against reversal of flow. The valves have an arrow molded into the body to indicate the direction of flow. Valves are designed for connection with either thermoplastic or soft metal tubing and are intended for use with liquids only.

Materials of Construction

Body	Acetal
O-ring	EPDM
Metal Grip Edge	300 Stainless
Working Pressure	Up to 150 PSI (10.3 bar) depending on tubing being used
Temperature Range	+34° to +150° F (+1° to +65° C)
Cracking Pressure	1/3 PSI (0.02 bar)

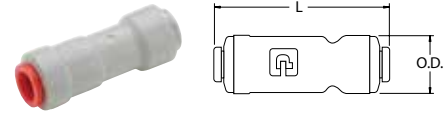

VC – Check Valve

PART NO.	TUBE SIZE	L	O.D.
A4VC4-MG	1/4	2.00	.66
A5VC5-MG	5/16	2.10	.70
A6VC6-MG	3/8	2.15	.80
A8VC8-MG	1/2	2.68	.91

NORYL® is a registered trademark of the General Electric Co.

PVDF Check Valves

Materials of Construction

Body	Kynar®
O-ring	Fluorocarbon
Metal Grip Edge	Stainless Steel
Working Pressure	Up to 300 PSI (20.7 bar)
Temperature Range	0° to +250° F (-17.8° to +121° C)



MCVC Kynar® Check Valves

PART NUMBER	TUBE O.D.	NPTF THREAD	L	C HEX	CRACKING PRESSURE PSI
FB6MCVC4-HBLK-05	3/8	1/4	1.40	13/16	.5
FB6MCVC4-HBLU-15	3/8	1/4	1.40	13/16	1.5
FB6MCVC4-HRED-30	3/8	1/4	1.40	13/16	3.0
FB6MCVC4-HGRN-40	3/8	1/4	1.40	13/16	4.0

Note: For check valve to function properly tubing needs to be installed

WARNING These products can expose you to chemicals including CARBON BLACK, which is known to the state of California to cause cancer. For more information go to www.P65Warnings.ca.gov.

Polypropylene Ball Valves

For proven leak-free performance, specify Polypropylene Ball Valves. Their corrosion-resistant, all-plastic design makes them ideal for water filtration units, coffee and beverage machines and a wide variety of other fluid applications. Polypropylene material meets all FDA and NSF-51 requirements for food contact.

Features/Benefits:

- Precision molded, all-plastic design is leak free and corrosion resistant.
- Polypropylene material offers a wider chemical acceptance range, as well as a wide temperature range.
- Bi-directional flow maximizes productivity.
- Full flow design reduces pressure drop across the valve.
- Special o-ring seal ensures a reliable leak-tight connection.
- TrueSeal™ connection reduces potential leaks.

Specifications:

- Temperature range: 0°F to +225°F (-18°C to +107°C).
- O-ring seal material: EPDM.
- NSF/ANSI 51 listed.
- Pressure rated to 150 PSI (10.3 bar) with a 600 PSI (41.4 bar) burst pressure. Actual working pressures will be lower at elevated temperatures.

Advantages:

- Reduce costs—Built-in TrueSeal™ connection eliminates the need for a secondary fitting.
- Save space—Low-profile design allows for easy assembly and access where space is at a premium.

Assembly Instructions:

1. Inspect the mating threads for debris or damage. Remove any old fluoropolymer tape or sealant on previously used threads. If threads are damaged, replace with new adapter before proceeding.
2. Apply 2 to 3 wraps of fluoropolymer tape, or an NSF/FDA approved silicon sealant. Do not use Plumbers Putty or Pipe Dope. These chemically react with plastic materials and could cause a failure.
3. Align ball valve to mating thread to ensure cross threading does not occur.
4. Screw ball valve onto mating thread 3 to 5 turns. This should be sufficient to properly seal the threads.
5. Pressurize system and check for leaks.

VME - Valve Male Elbow

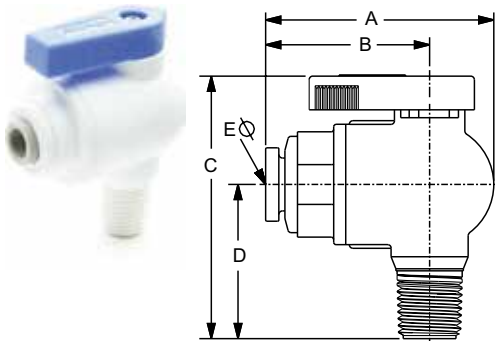

PART NUMBER	NOM. TUBE O.D.	NPTF THREAD SIZE	A	B	C	D	ØE THRU HOLE MIN.
PP4VME2-MG (+)	1/4	1/8	1.74	1.21	2.00	1.10	.19
PP4VME4-MG	1/4	1/4	1.74	1.21	2.18	1.28	.19
PP4VME6-MG	1/4	3/8	1.74	1.21	2.18	1.28	.19
PP4VME8-MG (+)	1/4	1/2	1.74	1.21	2.37	1.47	.19
PP6VME2-MG (+)	3/8	1/8	1.85	1.32	2.00	1.10	.25
PP6VME4-MG	3/8	1/4	1.85	1.32	2.18	1.28	.25
PP6VME6-MG	3/8	3/8	1.85	1.32	2.18	1.28	.25
PP6VME8-MG	3/8	1/2	1.85	1.32	2.37	1.47	.25

VFE - Valve Female Elbow

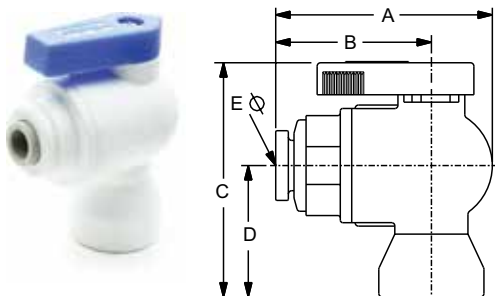

PART NUMBER	NOM. TUBE O.D.	NPTF THREAD SIZE	A	B	C	D	ØE THRU HOLE MIN.
PP4VFE2-MG (+)	1/4	1/8	1.74	1.21	1.82	.92	.19
PP4VFE4-MG	1/4	1/4	1.74	1.21	2.05	1.15	.19
PP4VFE6-MG	1/4	3/8	1.74	1.21	2.18	1.28	.19
PP6VFE2-MG (+)	3/8	1/8	1.85	1.32	1.82	.92	.25
PP6VFE4-MG	3/8	1/4	1.85	1.32	2.05	1.15	.25
PP6VFE6-MG	3/8	3/8	1.85	1.32	2.18	1.28	.25

(+) Non Standard.

WARNING These products can expose you to chemicals including CARBON BLACK, which is known to the state of California to cause cancer. For more information go to www.P65Warnings.ca.gov.

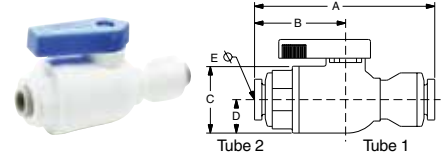

VUC - Valve Union Connector

BLACK POLYPROPYLENE	WHITE POLYPROPYLENE	1 TUBE SIZE	2 TUBE SIZE	A	B	C	D	ØE THRU HOLE MIN.
PPB4VUC4-MG	PP4VUC4-MG	1/4	1/4	2.55	1.22	1.0	.5	.19
	PP4VUC6-MG	1/4	3/8	2.55	1.22	1.0	.5	.19
	PP6VUC4-MG	3/8	1/4	2.57	1.30	1.0	.5	.19
PPB6VUC6-MG	PP6VUC6-MG	3/8	3/8	2.67	1.32	1.4	.5	.25

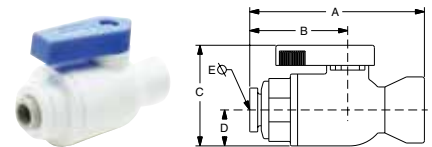

VFC - Valve Female Connector

BLACK POLYPROPYLENE	WHITE POLYPROPYLENE	NOM. TUBE O.D.	NPTF THREAD SIZE	A	B	C	D	ØE THRU HOLE MIN.
	PP4VFC2-MG	1/4	1/8	2.04	1.21	1.4	.5	.19
	PP4VFC4-MG	1/4	1/4	2.27	1.21	1.4	.5	.19
	PP4VFC6-MG	1/4	3/8	2.40	1.21	1.4	.5	.19
	PP6VFC2-MG	3/8	1/8	2.15	1.32	1.4	.5	.25
	PP6VFC4-MG	3/8	1/4	2.38	1.32	1.4	.5	.25
PPB6VFC6-MG	PP6VFC6-MG	3/8	3/8	2.51	1.32	1.4	.5	.25

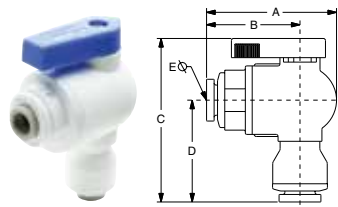

VEU - Valve Elbow Union

PART NUMBER	1 TUBE SIZE	2 TUBE SIZE	A	B	C	D	ØE THRU HOLE MIN.
PP4VEU4-MG	1/4	1/4	1.75	1.22	2.33	1.42	.19
PP4VEU6-MG	1/4	3/8	1.75	1.22	2.33	1.42	.11
PP6VEU4-MG	3/8	1/4	1.83	1.30	2.32	1.40	.19
PP6VEU6-MG	3/8	3/8	1.85	1.32	2.34	1.44	.25

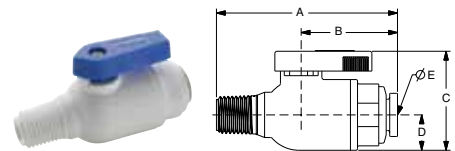

VMC - Valve Male Connector

PART NUMBER	NOM. TUBE O.D.	NPTF THREAD SIZE	A	B	C	D	ØE THRU HOLE MIN.
PP4VMC2-MG (+)	1/4	1/8	2.22	1.21	1.4	.5	.19
PP4VMC4-MG	1/4	1/4	2.40	1.21	1.4	.5	.19
PP4VMC6-MG	1/4	3/8	2.40	1.21	1.4	.5	.19
PP4VMC8-MG (+)	1/4	1/2	2.59	1.21	1.4	.5	.19
PP6VMC2-MG (+)	3/8	1/8	2.33	1.32	1.4	.5	.25
PP6VMC4-MG	3/8	1/4	2.51	1.32	1.4	.5	.25
PP6VMC6-MG	3/8	3/8	2.51	1.32	1.4	.5	.25
PP6VMC8-MG (+)	3/8	1/2	2.70	1.32	1.4	.5	.25

WARNING These products can expose you to chemicals including CARBON BLACK, which is known to the state of California to cause cancer. For more information go to www.P65Warnings.ca.gov.



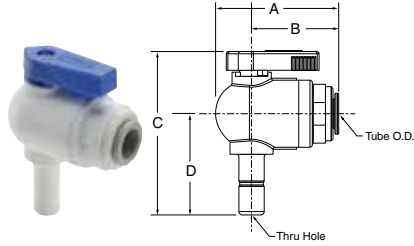

VTEU - Valve Tube Elbow Union

PART NUMBER	NOM. TUBE O.D.	STEM	A	B	C	D	ØE THRU HOLE MIN.
PP4VTEU6-MG	1/4	3/8	1.75	1.22	2.43	1.50	.17
PP6VTEU6-MG	3/8	3/8	1.83	1.30	2.43	1.50	.25



TS - Tube Supports

NYLON PART NUMBER	PPL PART NUMBER
N4TS3	P4TS3
N5TS3	P5TS3
N6TS4	P6TS4
N8TS6	P8TS6

To be used with soft durometer tubing.

SC - Safety Clip

(Patent No. 6,065,779)



PART NUMBER	PART NUMBER	FOR NOMINAL TUBE O.D.
SC-4	SC-4-B	1/4
SC-5	SC-5-B	5/16
SC-6	SC-6-B	3/8
SC-8	SC-8-B	1/2

AQRT - Quick Release Tool

Makes disconnection of tube adapters and tubing a breeze.



WARNING These products can expose you to chemicals including CARBON BLACK, which is known to the state of California to cause cancer. For more information go to www.P65Warnings.ca.gov.

Fast & Tite® Fittings



Parker's Fast & Tite Fittings are a compression style fitting that installs in seconds without tools and provides a tight, sure, leak proof seal without clamps or adjustments. A unique grab ring for tube retention, coupled with a Nitrile o-ring creates a positive seal and assures good tube retention with only hand tight assembly.

Product Features:

- Available in white polypropylene, black polypropylene and white nylon
- 302 stainless steel grab ring
- Nitrile O-ring
- FDA compliant material
- NSF/ANSI 51

Markets:

- Water Filtration
- Beverage Dispensing
- Life Science
- Bottling
- Semi-Conductor

Applications:

- Water
- Beverages
- Food
- Cooling Systems

Compatible Tubing:

- Thermoplastic
- Soft Metal
- Glass

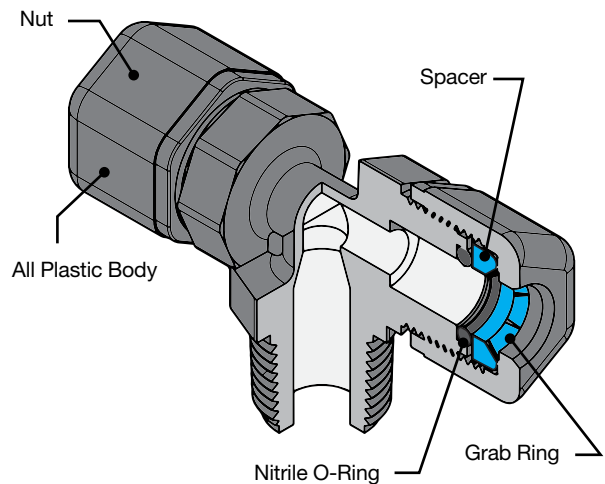

Specifications:

Air-Oil-Water Pressure in PSI (bar)

TUBE O. D. IN.	UP TO 75° F	76° TO 125° F	126° TO 175° F
1/4	300 (20.7)	300 (20.7)	300 (20.7)
5/16	300 (20.7)	300 (20.7)	300 (20.7)
3/8	250 (17.2)	250 (17.2)	150 (10.3)
1/2	200 (13.8)	200 (13.8)	150 (10.3)
5/8	150 (10.3)	100 (6.9)	50 (3.5)

Temperature Range

Nylon: -40° to +200° F (-40° to +93.3° C)

Polypropylene: 0° to +212° F (-17.8° to +100° C)

TUBE O. D. (IN.)	INSERTION LENGTH
1/4	5/8
5/16	5/8
3/8	13/16
1/2	7/8
5/8	1

Assembly Instructions

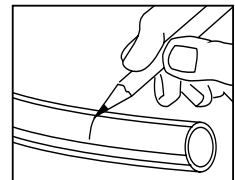
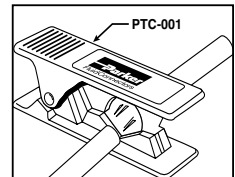

1. Cut the tube squarely and remove any burrs.
2. Mark from end of tube the length of insertion. If using a tube support, insert fully into tube before marking. (See insertion length table left)
3. Loosen nut on fitting until three threads are visible. Fittings for glass tubes must be disassembled and the grab ring removed. If the fitting has been disassembled the components are to be placed in the following order: fitting body, o-ring, spacer, grab ring and nut. Assemble the nut until three threads are showing on the body before inserting tube.
4. Moisten end of the tube with water. Push the tube straight into fitting until it bottoms on the fitting's shoulder. Tighten nut by hand. Additional tightening should not be necessary, but 1/4 additional turn may be added if desired. Do not overtighten nut as the threads will strip and the fitting will not function properly. A proper assembly will not show the insertion mark extending beyond the nut. If the insertion mark is visible, then steps 1 thru 4 must be repeated.
5. Whenever a Fast & Tite® fitting is assembled for service or reuse the stainless steel grab ring should be replaced for maximum tubing retention.



Note: Provide adequate fail-safe mechanisms such as leakage detection sensors, automatic shut-off controls or other industry and code appropriate fail-safe devices in the design of your water-handling appliance to protect against personal injury and property damage. Plastic fittings containing an o-ring have a finite life depending on the environment, media and severity of the application. Frequent inspections and replacement of the fitting when anomalies are found is recommended.

WARNING These products can expose you to chemicals including CARBON BLACK, which is known to the state of California to cause cancer. For more information go to www.P65Warnings.ca.gov.



Tube to NPTF	MC Male Connector  p. C31	ME Male Elbow  p. C31	MR Male Run Tee  p. C32	MT Male Branch Tee  p. C32		
	FE Female Elbow  p. C32	FC Female Connector  p. C32	Tube to Tube	UC Union  p. C31	EU Union Elbow  p. C31	TU Union Tee  p. C32
	BU Bulkhead Union  p. C32	Auxiliary Components		GR Grab Ring  p. C33	NS Nut & Spacer  p. C33	TS Tube Support  p. C33
	Bulkhead Union					

WARNING These products can expose you to chemicals including CARBON BLACK, which is known to the state of California to cause cancer. For more information go to www.P65Warnings.ca.gov.

MC - Male Connector

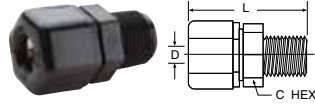

Tube to male pipe

WHITE PPL PART NUMBER	BLACK PPL PART NUMBER	WHITE NYLON PART NUMBER	NOM TUBE O.D.	NPTF THREAD SIZE	C HEX	L OVERALL LENGTH	FLOW DIA. D
W4MC2	P4MC2	N4MC2	1/4	1/8	11/16	1.28	.170
W4MC4	P4MC4	N4MC4	1/4	1/4	11/16	1.51	.170
W4MC6 (+)	P4MC6 (+)	N4MC6 (+)	1/4	3/8	11/16	1.48	.170
W5MC2 (+)	P5MC2	N5MC2	5/16	1/8	11/16	1.38	.170
W5MC4 (+)	P5MC4	N5MC4	5/16	1/4	11/16	1.50	.250
W6MC2 (+)	P6MC2	N6MC2	3/8	1/8	13/16	1.50	.170
W6MC4	P6MC4	N6MC4	3/8	1/4	13/16	1.67	.250
W6MC6	P6MC6	N6MC6	3/8	3/8	13/16	1.67	.250
W6MC8 (+)	P6MC8	N6MC8	3/8	1/2	1	1.78	.250
W6MC12	P6MC12	N6MC12	3/8	3/4	1	1.84	.250
W8MC2 (+)	P8MC2	N8MC2	1/2	1/8	1	1.61	.170
W8MC4 (+)	P8MC4	N8MC4	1/2	1/4	1	1.74	.250
W8MC6	P8MC6	N8MC6	1/2	3/8	1	1.74	.375
W8MC8	P8MC8	N8MC8	1/2	1/2	1	1.87	.375
W8MC12 (+)	P8MC12	N8MC12	1/2	3/4	1	1.89	.375
W10MC2 (+)	P10MC2	N10MC2	5/8	1/8	1-1/8	1.75	.170
W10MC4 (+)	P10MC4	N10MC4	5/8	1/4	1-1/8	1.90	.250
W10MC6 (+)	P10MC6	N10MC6	5/8	3/8	1-1/8	1.90	.375
W10MC8 (+)	P10MC8	N10MC8	5/8	1/2	1-1/8	2.01	.500
W10MC12 (+)	P10MC12	N10MC12	5/8	3/4	1-1/8	2.04	.500

ME - Male Elbow

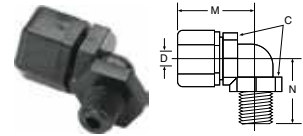

Tube to male pipe

WHITE PPL PART NUMBER	BLACK PPL PART NUMBER	WHITE NYLON PART NUMBER	NOM TUBE O.D.	NPTF THD SIZE	C HEX	M	N	FLOW DIA. D
W4ME2	P4ME2	N4ME2	1/4	1/8	3/4	1.06	0.81	.170
W4ME4	P4ME4	N4ME4	1/4	1/4	3/4	1.06	1.02	.170
W4ME6	P4ME6	N4ME6	1/4	3/8	3/4	1.06	1.02	.170
W5ME2 (+)	P5ME2	N5ME2	5/16	1/8	3/4	1.06	0.81	.193
W5ME4 (+)	P5ME4	N5ME4	5/16	1/4	3/4	1.06	1.02	.193
W5ME6 (+)	P5ME6	N5ME6	5/16	3/8	3/4	1.06	1.02	.193
W6ME4	P6ME4	N6ME4	3/8	1/4	7/8	1.28	1.12	.250
W6ME6	P6ME6	N6ME6	3/8	3/8	7/8	1.28	1.12	.250
W6ME8	P6ME8	N6ME8	3/8	1/2	1	1.28	1.34	.250
W6ME12 (+)	P6ME12	N6ME12	3/8	3/4	1-3/16	1.59	1.40	.250
W8ME4 (+)	P8ME4	N8ME4 (+)	1/2	1/4	1-1/16	1.48	1.22	.250
W8ME6	P8ME6	N8ME6	1/2	3/8	1-1/16	1.56	1.21	.375
W8ME8	P8ME8	N8ME8	1/2	1/2	1-1/16	1.56	1.34	.375
W8ME12 (+)	P8ME12 (+)	N8ME12 (+)	1/2	3/4	1-1/8	1.50	1.40	.375
W10ME8 (+)	P10ME8	N10ME8	5/8	1/2	1-3/16	1.72	1.40	.500

UC - Union Connector

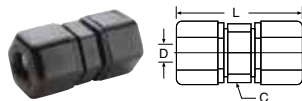

Tube to tube

WHITE PPL PART NUMBER	BLACK PPL PART NUMBER	WHITE NYLON PART NUMBER	NOM. TUBE O.D.	C HEX	L OVERALL LENGTH	FLOW DIA. D
W4UC4	P4UC4	N4UC4	1/4	11/16	1.62	.170
W5UC4 (+)	P5UC4	N5UC4	5/16-1/4	11/16	1.62	.170
W5UC5 (+)	P5UC5	N5UC5	5/16	11/16	1.62	.190
W6UC4	P6UC4	N6UC4	3/8-1/4	13/16	1.80	.170
W6UC5 (+)	P6UC5	N6UC5	3/8-5/16	13/16	1.80	.190
W6UC6	P6UC6	N6UC6	3/8	13/16	1.92	.250
W8UC6	P8UC6	N8UC6	1/2-3/8	1	1.95	.250
W8UC8	P8UC8	N8UC8	1/2	1	2.03	.375
W10UC6 (+)	P10UC6	N10UC6	5/8-3/8	1-1/8	2.19	.250
W10UC8 (+)	P10UC8	N10UC8	5/8-1/2	1-1/8	2.24	.375
W10UC10 (+)	P10UC10	N10UC10	5/8	1-1/8	2.40	.500

EU - Elbow Union

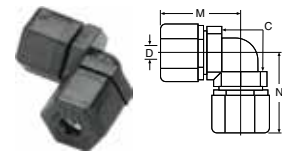

Tube to tube

WHITE PPL PART NUMBER	BLACK PPL PART NUMBER	WHITE NYLON PART NUMBER	NOM. TUBE O.D.	C HEX	M	N	FLOW DIA. D
W4EU4	P4EU4	N4EU4	1/4	3/4	1.06	1.06	.170
W5EU4 (+)	P5EU4	N5EU4	5/16-1/4	3/4	1.06	1.06	.170
W5EU5 (+)	P5EU5	N5EU5	5/16	3/4	1.06	1.06	.193
W6EU4	P6EU4	N6EU4	3/8-1/4	7/8	1.06	1.28	.170
W6EU5 (+)	P6EU5	N6EU5	3/8-5/16	7/8	1.06	1.28	.170
W6EU6	P6EU6	N6EU6	3/8	7/8	1.28	1.28	.250
W8EU6	P8EU6	N8EU6	1/2-3/8	1-1/16	1.37	1.56	.250
W8EU8	P8EU8	N8EU8	1/2	1-1/16	1.56	1.56	.375
W10EU10 (+)	P10EU10	N10EU10	5/8	1-3/16	1.72	1.72	.500

(+) Non-standard

WARNING These products can expose you to chemicals including CARBON BLACK, which is known to the state of California to cause cancer. For more information go to www.P65Warnings.ca.gov.

BU - Bulkhead Union



Tube to tube

WHITE PPL PART NUMBER	BLACK PPL PART NO.	WHITE NYLON PART NO.	NOM TUBE O.D.	A REF.	C HEX	L OVERALL LENGTH	P MAX	FLOW DIA. D	BLKHD HOLE DRILL SIZE
W4BU4	P4BU4	N4BU4	1/4	1/4	13/16	2-11/64	3/8	.170	21/32
W5BU5 (+)	P5BU5	N5BU5	5/16	1/4	13/16	2-11/64	3/8	.187	21/32
W6BU6	P6BU6	N6BU6	3/8	9/32	15/16	2-39/64	1/2	.250	25/32
W8BU8	P8BU8	N8BU8	1/2	5/16	1-5/32	2-3/4	1/2	.375	31/32

MR - Male Run Tee

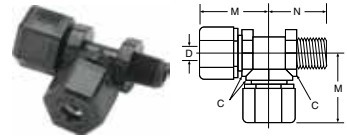

Tube to male pipe

WHITE PPL PART NUMBER	BLACK PPL PART NUMBER	WHITE NYLON PART NUMBER	NOM TUBE O.D.	NPTF THD SIZE	C HEX	M	N	FLOW DIA. D
W4MR2	P4MR2	N4MR2	1/4	1/8	11/16	1.09	0.89	.170
W6MR4	P6MR4	N6MR4	3/8	1/4	13/16	1.30	1.17	.250
W8MR6	P8MR6	N8MR6	1/2	3/8	1	1.46	1.28	.375
W10MR8 (+)	P10MR8	N10MR8	5/8	1/2	1-1/8	1.68	1.50	.500

FE - Female Elbow

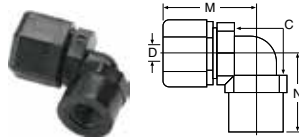

Tube to female pipe

WHITE PPL PART NUMBER	BLACK PPL PART NUMBER	WHITE NYLON PART NUMBER	NOM TUBE O.D.	NPTF THD SIZE	C HEX	M	N	FLOW DIA. D
W4FE2	P4FE2	N4FE2	1/4	1/8	11/16	1.10	0.84	.170
W4FE4	P4FE4	N4FE4	1/4	1/4	11/16	1.10	0.94	.170
W5FE2 (+)	P5FE2	N5FE2	5/16	1/8	11/16	1.10	0.84	.193
W6FE4	P6FE4	N6FE4	3/8	1/4	13/16	1.30	1.06	.250
W6FE6	P6FE6	N6FE6	3/8	3/8	13/16	1.30	1.03	.250
W8FE6 (+)	P8FE6	N8FE6	1/2	3/8	1	1.50	1.16	.375
W8FE8	P8FE8	N8FE8	1/2	1/2	1	1.50	1.27	.375
W10FE8 (+)	P10FE8	N10FE8	5/8	1/2	1-1/8	1.70	1.34	.500

TU - Tee Union

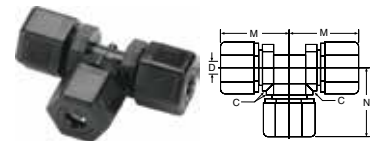

Tube to tube

WHITE PPL PART NUMBER	BLACK PPL PART NUMBER	WHITE NYLON PART NUMBER	NOM. TUBE O.D.	C HEX	M	N	FLOW DIA. D
W4TU4	P4TU4	N4TU4	1/4	11/16	1.09	1.09	.170
W5TU5 (+)	P5TU5	N5TU5	5/16	11/16	1.09	1.09	.187
W6TU6	P6TU6	N6TU6	3/8	13/16	1.30	1.30	.250
W8TU6 (+)	P8TU6	N8TU6	1/2-3/8	1	1.46	1.39	.250
W8TU8	P8TU8	N8TU8	1/2	1	1.46	1.46	.375
W10TU6 (+)	P10TU6	N10TU6	5/8-3/8	1-1/8	1.68	1.46	.250
W10TU10 (+)	P10TU10	N10TU10	5/8	1-3/16	1.68	1.68	.500

FC - Female Connector



Tube to female pipe

WHITE PPL PART NUMBER	BLACK PPL PART NUMBER	WHITE NYLON PART NUMBER	NOM TUBE O.D.	NPTF THREAD SIZE	C HEX	L	FLOW DIA. D
W4FC2	P4FC2	N4FC2	1/4	1/8	11/16	1.31	.170
W4FC4	P4FC4	N4FC4	1/4	1/4	11/16	1.44	.170
W6FC4	P6FC4	N6FC4	3/8	1/4	13/16	1.61	.250
W6FC6	P6FC6	N6FC6	3/8	3/8	13/16	1.64	.250
W6FC8	P6FC8	N6FC8	3/8	1/2	13/16	1.75	.250
W8FC6 (+)	P8FC6	N8FC6	1/2	3/8	1	1.70	.375
W8FC8	P8FC8	N8FC8	1/2	1/2	1	1.85	.375
W10FC8 (+)	P10FC8	N10FC8	5/8	1/2	1-1/8	1.96	.500

MT - Male Branch Tee

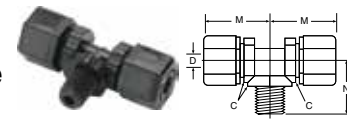

Tube to male pipe

WHITE PPL PART NUMBER	BLACK PPL PART NUMBER	WHITE NYLON PART NUMBER	NOM. TUBE O.D.	NPTF THD SIZE	C HEX	M	N	FLOW DIA. D
W4MT2	P4MT2	N4MT2	1/4	1/8	11/16	1.09	0.89	.170
W4MT4	P4MT4	N4MT4	1/4	1/4	11/16	1.09	1.06	.170
W5MT2 (+)	P5MT2	N5MT2	5/16	1/8	11/16	1.09	0.89	.170
W5MT4 (+)	P5MT4	N5MT4	5/16	1/4	11/16	1.09	1.06	.187
W6MT4	P6MT4	N6MT4	3/8	1/4	13/16	1.30	1.12	.250
W6MT6	P6MT6	N6MT6	3/8	3/8	13/16	1.30	1.10	.250
W8MT6	P8MT6	N8MT6	1/2	3/8	1	1.46	1.22	.375
W8MT8	P8MT8	N8MT8	1/2	1/2	1	1.46	1.43	.375
W10MT8 (+)	P10MT8	N10MT8	5/8	1/2	1-1/8	1.68	1.41	.500

(+) Non-standard

WARNING These products can expose you to chemicals including CARBON BLACK, which is known to the state of California to cause cancer. For more information go to www.P65Warnings.ca.gov.



GR - Grab Ring



(Stainless or Plastic)

STAINLESS GRAB RING PART NUMBER	PLASTIC GRAB RING PART NUMBER	FOR NOM. TUBE O. D.
4GR	4GRP	1/4
5GR	5GRP	5/16
6GR	6GRP	3/8
8GR	8GRP	1/2
10GR	10GRP	5/8

NS - Nut and Spacer Sets



WHITE POLYPROPYLENE PART NUMBER	BLACK POLYPROPYLENE PART NUMBER	WHITE NYLON PARTNUMBER	FOR NOM. TUBE O. D.
W4NS	P4NS	N4NS	1/4
W5NS	P5NS	N5NS	5/16
W6NS	P6NS	N6NS	3/8
W8NS	P8NS	N8NS	1/2
W10NS	P10NS	N10NS	5/8

TS - Tube Support



POLYPROPYLENE PART NUMBER	NYLON PART NUMBER	FOR TUBE PART NUMBER
P4TS3	N4TS3	PV43
P5TS3	N5TS3	PV53
P6TS4	N6TS3	PV64
P8TS6	N8TS6	PV86
P10TS8	N10TS8	PV108

OR - O-Ring



FOR NOM. TUBE O. D.	NITRILE O-RING	FLUOROCARBON O-RING	EPDM O-RING
1/4	4OR	4OR-V	4OR-EPDM
5/16	5OR	5OR-V	5OR-EPDM
3/8	6OR	6OR-V	6OR-EPDM
1/2	8OR	8OR-V	8OR-EPDM
5/8	10OR	10OR-V	10OR-EPDM

WARNING These products can expose you to chemicals including CARBON BLACK, which is known to the state of California to cause cancer. For more information go to www.P65Warnings.ca.gov.



Par-Barb® Fittings



Parker's Par-Barb Fittings are injection molded from high strength chemically inert, thermoplastic materials. The multiple barb design generates the maximum gripping and sealing power when combined with a hose clamp.

Product Features:

- Available in black polypropylene and white nylon
- FDA compliant material
- NSF/ANSI 51
- Uniprene washer
- Up to 1 1/2" sizes

Markets:

- Water
- Beverage Dispensing
- Bottling
- Semi-Conductor

Applications:

- Water
- Beverages
- Cooling Systems



Specifications:

Pressure Range Up to 125 psi PSI (8.6 bar)

Temperature Range

Nylon: -40° to +200° F (-40° to +93.3° C)

Polypropylene: 0° to +212° F (-12.2° to +100° C)

Compatible Tubing:

- Vinyl
- Polyurethane
- Rubber hose



WARNING These products can expose you to chemicals including NICKEL, CARBON BLACK, TITANIUM DIOXIDE, or LEAD, which are known to the state of California to cause cancer, and LEAD which is known to cause birth defects or other reproductive harm. For more information go to www.P65Warnings.ca.gov.



Tube to Male NPTF	325HB Male Connector  p. C38	372HB Male Branch Tee  p. C39	329HB Male Elbow  p. C39	Tube to Female NPTF	326HB Female Connector  p. C38	370HB Female Elbow  p. C39
	322HB Union  p. C37	364HB Union Tee  p. C37	365HB Union Elbow  p. C37		362HB Union Y  p. C39	
Pipe Fittings	318P Hex Plug  p. C37	309P Bushing  p. C37	316P Nipple  p. C38	Garden Hose Fitting	316GH Garden Hose Adapter  p. C40	325GH Garden Hose Connector  p. C40
	328HB Hose Barb Stem  p. C40	31HB Hose Barb Swivel Nut  p. C40	325GHSV Swivel Hose Barb Stem  p. C40		31GH Garden Hose Nut  p. C40	313GH Garden Hose Cap  p. C40
Auxiliary Component	VFC Female Connector  p. C41	VFE Female Elbow  p. C41	VMC Male Connector  p. C41	VME Male Elbow  p. C41	VUC Union Connector  p. C41	VUCPB Barb x Tuber  p. C41
Ball Valves	VFC Female Connector  p. C41	VFE Female Elbow  p. C41	VMC Male Connector  p. C41	VME Male Elbow  p. C41	VUC Union Connector  p. C41	VUCPB Barb x Tuber  p. C41

WARNING These products can expose you to chemicals including NICKEL, CARBON BLACK, TITANIUM DIOXIDE, or LEAD, which are known to the state of California to cause cancer, and LEAD which is known to cause birth defects or other reproductive harm. For more information go to www.P65Warnings.ca.gov.



Union Connector 322HB

WHITE NYLON PART NO.	BLACK POLYPROPYLENE PART NO.	TUBE OR HOSE I.D. 1	TUBE OR HOSE I.D. 2	O.D. 1	O.D. 2	L	FLOW DIA. D
322HB-2N*	322HB-2PP*	1/8	1/8	.18	.18	.66	.09
322HB-3N	322HB-3PP	3/16	3/16	.25	.25	1.61	.12
322HB-4-2N	322HB-4-2PP	1/4	1/8	.31	.21	1.61	.08
322HB-4-3N	322HB-4-3PP	1/4	3/16	.31	.25	1.61	.13
322HB-4N	322HB-4PP	1/4	1/4	.31	.31	1.61	.16
322HB-5N	322HB-5PP	5/16	5/16	.37	.37	1.61	.22
322HB-6-4N	322HB-6-4PP	3/8	1/4	.43	.31	1.61	.15
322HB-6-5N	322HB-6-5PP	3/8	5/16	.43	.37	1.62	.22
322HB-6N	322HB-6PP	3/8	3/8	.43	.43	1.61	.25
322HB-8-4N	322HB-8-4PP	1/2	1/4	.55	.31	1.73	.15
322HB-8-6N	322HB-8-6PP	1/2	3/8	.55	.43	1.73	.25
322HB-8N	322HB-8PP	1/2	1/2	.56	.56	1.74	.38
322HB-10-6N	322HB-10-6PP	5/8	3/8	.66	.43	1.73	.25
322HB-10-8N	322HB-10-8PP	5/8	1/2	.66	.55	1.73	.37
322HB-10N	322HB-10PP	5/8	5/8	.67	.67	1.73	.47
322HB-12-8N	322HB-12-8PP	3/4	1/2	.81	.55	2.99	.38
322HB-12N	322HB-12PP	3/4	3/4	.80	.80	2.97	.58
322HB-16N		1	1	1.08	1.08	3.12	.82
322HB-20N		1-1/4	1-1/4	1.26	1.26	3.58	1.00
322HB-24N		1-1/2	1-1/2	1.51	1.51	3.58	1.25

*Note: 1/8" tube connections contain one barb.

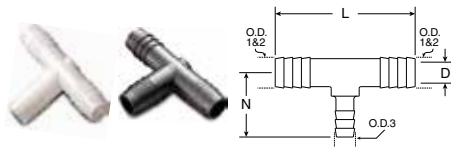

Union Tee 364HB

WHITE NYLON PART NO.	BLACK POLYPROPYLENE PART NO.	TUBE OR HOSE I.D. 1-2	TUBE OR HOSE I.D. 3	O.D. 1-2	O.D. 3	L	N	FLOW DIA. D
364HBM-2N*		1/8	1/8	.15	.15	1.19	.60	.08
364HB-3N	364HB-3PP	3/16	3/16	.25	.25	1.49	.75	.12
364HB-4N	364HB-4PP	1/4	1/4	.32	.32	1.92	.96	.16
364HB-4-6N		1/4	3/8	.32	.44	1.92	1.18	.16
364HB-5N	364HB-5PP	5/16	5/16	.36	.36	2.22	1.17	.22
364HB-6-3N	364HB-6-3PP	3/8	3/16	.43	.24	2.23	1.04	.09
364HB-6-4N	364HB-6-4PP	3/8	1/4	.44	.32	1.92	1.18	.16
364HB-6N	364HB-6PP	3/8	3/8	.43	.43	2.22	1.18	.25
364HB-6-8N	364HB-6-8PP	3/8	1/2	.43	.56	2.22	1.27	.25
364HB-8-6N	364HB-8-6PP	1/2	3/8	.55	.43	2.52	1.27	.25
364HB-8N	364HB-8PP	1/2	1/2	.56	.56	2.52	1.27	.37
364HB-10N	364HB-10PP	5/8	5/8	.66	.66	2.74	1.37	.46
364HB-12N		3/4	3/4	.81	.81	2.98	1.50	.58
364HB-16N		1	1	1.06	1.06	3.10	1.55	.81
364HB-20N		1-1/4	1-1/4	1.25	1.25	5.29	2.64	1.00
364HB-24N		1-1/2	1-1/2	1.51	1.51	5.48	2.74	1.25

*Note: 1/8" tube connections contain one barb.



Union Elbow 365HB

WHITE NYLON PART NO.	BLACK POLYPROPYLENE PART NO.	TUBE OR HOSE I.D. 1	TUBE OR HOSE I.D. 2	O.D. 1	O.D. 2	M	N	FLOW DIA. D
365HB-3N	365HB-3PP	3/16	3/16	.25	.25	.75	.75	.12
365HB-4N	365HB-4PP	1/4	1/4	.31	.31	1.13	1.13	.15
365HB-5N	365HB-5PP	5/16	5/16	.38	.37	1.19	1.19	.22
365HB-6N	365HB-6PP	3/8	3/8	.43	.43	1.26	1.26	.25
365HB-8-4N	365HB-8-4PP	1/2	1/4	.55	.31	1.26	1.24	.16
365HB-8-6N	365HB-8-6PP	1/2	3/8	.55	.43	1.26	1.27	.25
365HB-8N	365HB-8PP	1/2	1/2	.55	.55	1.26	1.26	.37
365HB-10N	365HB-10PP	5/8	5/8	.66	.66	1.37	1.37	.46
365HB-12N	365HB-12PP	3/4	3/4	.80	.80	1.48	1.48	.57
365HB-16N		1	1	1.07	1.07	1.50	1.50	.81
365HB-20N		1-1/4	1-1/4	1.25	1.25	2.63	2.63	1.00
365HB-24N		1-1/2	1-1/2	1.50	1.50	2.74	2.74	1.25



Hex Plug 318P

WHITE NYLON PART NO.	BLACK POLYPROPYLENE PART NO.	NPT PIPE THREAD	C HEX	L
318P-2N	318P-2PP	1/8	7/16	.62
318P-4N	318P-4PP	1/4	9/16	.75
318P-6N	318P-6PP	3/8	11/16	.74
318P-8N	318P-8PP	1/2	7/8	.87
318P-12N	318P-12PP	3/4	1-1/8	.86
318P-16N	318P-16PP	1	1-3/8	1.05
318P-20N	318P-20PP	1-1/4	1-1/2	1.44
318P-24N	318P-24PP	1-1/2	1-3/4	1.61



Reducer Bushing 309P

WHITE NYLON PART NO.	BLACK POLYPROPYLENE PART NO.	EXTERNAL NPT PIPE THREAD	INTERNAL NPT PIPE THREAD	C HEX	L
309P-4-2N	309P-4-2PP	1/4	1/8	9/16	.75
309P-6-2N	309P-6-2PP	3/8	1/8	11/16	.74
309P-6-4N	309P-6-4PP	3/8	1/4	11/16	.75
309P-8-2N	309P-8-2PP	1/2	1/8	7/8	.88
309P-8-4N	309P-8-4PP	1/2	1/4	7/8	.87
309P-8-6N	309P-8-6PP	1/2	3/8	7/8	.87
309P-12-2N	309P-12-2PP	3/4	1/8	1-1/8	.86
309P-12-4N	309P-12-4PP	3/4	1/4	1-1/8	.75
309P-12-6N	309P-12-6PP	3/4	3/8	1-1/8	.85
309P-12-8N	309P-12-8PP	3/4	1/2	1-1/8	.87

WARNING These products can expose you to chemicals including NICKEL, CARBON BLACK, TITANIUM DIOXIDE, or LEAD, which are known to the state of California to cause cancer, and LEAD which is known to cause birth defects or other reproductive harm. For more information go to www.P65Warnings.ca.gov.



Hex Nipple 316P

WHITE NYLON PART NO.	BLACK POLYPROPYLENE PART NO.	NPT PIPE THREAD SIDE 1	NPT PIPE THREAD SIDE 2	C HEX	L	FLOW DIA. D
316P-2N	316P-2PP	1/8	1/8	7/16	.99	.22
316P-4-2N	316P-4-2PP	1/4	1/8	9/16	1.13	.22
316P-4N	316P-4PP	1/4	1/4	9/16	1.24	.31
316P-6-2N	316P-6-2PP	3/8	1/8	11/16	1.11	.22
316P-6-4N	316P-6-4PP	3/8	1/4	11/16	1.25	.31
316P-6N	316P-6PP	3/8	3/8	11/16	1.23	.43
316P-8-2N	316P-8-2PP	1/2	1/8	7/8	1.23	.22
316P-8-4N	316P-8-4PP	1/2	1/4	7/8	1.36	.31
316P-8-6N	316P-8-6PP	1/2	3/8	7/8	1.35	.43
316P-8N	316P-8PP	1/2	1/2	7/8	1.45	.59
316P-12-6N	316P-12-6PP	3/4	3/8	1- 1/8	1.36	.43
316P-12-8N	316P-12-8PP	3/4	1/2	1- 1/8	1.47	.59
316P-12N	316P-12PP	3/4	3/4	1- 1/8	1.48	.74
316P-16N	316P-16PP	1	1	1- 3/8	1.85	.98



Female Connector 326HB

WHITE NYLON PART NO.	BLACK POLYPROPYLENE PART NO.	TUBE OR HOSE I.D.	NPT PIPE THREAD	O.D.	C HEX	L	FLOW DIA. D
326HB-3-2N	326HB-3-2PP	3/16	1/8	.25	5/8	1.29	.12
326HB-3-4N	326HB-3-4PP	3/16	1/4	.25	3/4	1.31	.13
326HB-4-2N	326HB-4-2PP	1/4	1/8	.31	5/8	1.51	.16
326HB-4-4N	326HB-4-4PP	1/4	1/4	.31	3/4	1.52	.15
326HB-4-6N	326HB-4-6PP	1/4	3/8	.31	1	1.73	.15
326HB-4-8N	326HB-4-8PP	1/4	1/2	.31	1-1/8	1.74	.15
326HB-6-2N	326HB-6-2PP	3/8	1/8	.44	5/8	1.51	.25
326HB-6-4N	326HB-6-4PP	3/8	1/4	.43	3/4	1.52	.25
326HB-6-6N	326HB-6-6PP	3/8	3/8	.43	1	1.73	.25
326HB-6-8N	326HB-6-8PP	3/8	1/2	.43	1-1/8	1.74	.25
326HB-8-4N	326HB-8-4PP	1/2	1/4	.55	3/4	1.52	.37
326HB-8-6N	326HB-8-6PP	1/2	3/8	.55	1	1.74	.37
326HB-8-8N	326HB-8-8PP	1/2	1/2	.56	1- 1/8	1.74	.37
326HB-10-6N	326HB-10-6PP	5/8	3/8	.66	1	1.61	.46
326HB-10-8N	326HB-10-8PP	5/8	1/2	.66	1- 1/8	1.73	.46
326HB-12-8N	326HB-12-8PP	3/4	1/2	.80	1- 1/8	1.86	.62
326HB-12-12N	326HB-12-12PP	3/4	3/4	.80	1- 1/8	1.85	.62

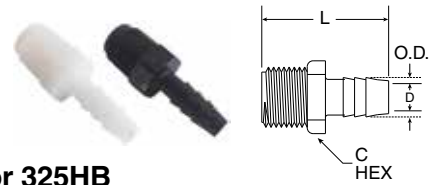

Male Connector 325HB

WHITE NYLON PART NO.	BLACK POLYPROPYLENE PART NO.	TUBE OR HOSE I.D.	NPT PIPE THD.	O.D.	C HEX	L	FLOW DIA. D
325HB-3-2N	325HB-3-2PP	3/16	1/8	.25	7/16	1.49	.12
325HB-3-4N	325HB-3-4PP	3/16	1/4	.25	9/16	1.61	.13
325HB-4-2N	325HB-4-2PP	1/4	1/8	.31	7/16	1.50	.15
325HB-4-4N	325HB-4-4PP	1/4	1/4	.31	9/16	1.60	.16
325HB-4-6N		1/4	3/8	.31	11/16	1.62	.16
325HB-4-8N	325HB-4-8PP	1/4	1/2	.31	7/8	1.73	.15
325HB-4-12N		1/4	3/4	.31	1- 1/8	1.74	.16
325HB-5-2N		5/16	1/8	.37	7/16	1.50	.22
325HB-5-4N		5/16	1/4	.37	9/16	1.62	.22
325HB-5-6N	325HB-5-6PP	5/16	3/8	.37	11/16	1.60	.21
325HB-6-2N	325HB-6-2PP	3/8	1/8	.43	7/16	1.49	.25
325HB-6-4N	325HB-6-4PP	3/8	1/4	.43	9/16	1.62	.25
325HB-6-6N	325HB-6-6PP	3/8	3/8	.43	11/16	1.61	.25
325HB-6-8N	325HB-6-8PP	3/8	1/2	.43	7/8	1.73	.25
325HB-6-12N	325HB-6-12PP	3/8	3/4	.43	1- 1/8	1.72	.25
325HB-8-4N	325HB-8-4PP	1/2	1/4	.55	9/16	1.61	.35
325HB-8-6N	325HB-8-6PP	1/2	3/8	.55	11/16	1.60	.37
325HB-8-8N	325HB-8-8PP	1/2	1/2	.55	7/8	1.73	.37
325HB-8-12N	325HB-8-12PP	1/2	3/4	.55	1- 1/8	1.72	.37
325HB-10-6N	325HB-10-6PP	5/8	3/8	.66	11/16	1.61	.46
325HB-10-8N	325HB-10-8PP	5/8	1/2	.66	7/8	1.73	.46
325HB-10-12N	325HB-10-12PP	5/8	3/4	.67	1- 1/8	1.82	.46
325HB-12-8N	325HB-12-8PP	3/4	1/2	.80	7/8	1.86	.62
325HB-12-12N	325HB-12-12PP	3/4	3/4	.80	1- 1/8	1.85	.62
325HB-12-16N		3/4	1	.82	1- 3/8	2.35	.59
325HB-12-20N		3/4	1- 1/4	.86	1- 1/2	3.47	.59
325HB-12-24N		3/4	1- 1/2	.86	1- 3/4	3.66	.59
325HB-16-8N		1	1/2	1.08	1- 1/8	2.49	.77
325HB-16-12N		1	3/4	1.07	1- 1/8	2.30	.81
325HB-16-16N		1	1	1.07	1- 3/8	2.35	.81
325HB-16-20N		1	1- 1/4	1.11	1- 1/2	3.45	.78
325HB-16-24N		1	1- 1/2	1.11	1- 3/4	3.63	.78
325HB-20-20N		1- 1/4	1- 1/4	1.36	1- 1/2	3.47	1.04
325HB-20-24N		1- 1/4	1- 1/2	1.36	1- 3/4	3.64	1.04
325HB-24-20N		1- 1/2	1- 1/4	1.60	1- 1/2	3.45	1.28
325HB-24-24N		1- 1/2	1- 1/2	1.61	1- 3/4	3.63	1.28

WARNING These products can expose you to chemicals including NICKEL, CARBON BLACK, TITANIUM DIOXIDE, or LEAD, which are known to the state of California to cause cancer, and LEAD which is known to cause birth defects or other reproductive harm. For more information go to www.P65Warnings.ca.gov.



Male Branch Tee 372HB

WHITE NYLON PART NO.	BLACK POLYPROPYLENE PART NO.	TUBE OR HOSE I.D.	NPT PIPE THD.	O.D.	C HEX	L	N	FLOW DIA. D
372HB-3-2N		3/16	1/8	.25	7/16	1.94	1.06	.13
372HB-3-4N		3/16	1/4	.24	9/16	1.93	1.17	.13
372HB-4-2N	372HB-4-2PP	1/4	1/8	.32	7/16	1.92	1.06	.16
372HB-4-4N	372HB-4-4PP	1/4	1/4	.32	9/16	1.92	1.16	.16
372HB-4-6N	372HB-4-6PP	1/4	3/8	.32	11/16	1.92	1.18	.16
372HB-6-4N	372HB-6-4PP	3/8	1/4	.43	9/16	2.22	1.18	.25
372HB-6-6N	372HB-6-6PP	3/8	3/8	.43	11/16	2.22	1.17	.25
372HB-6-8N	372HB-6-8PP	3/8	1/2	.43	7/8	2.22	1.29	.25
372HB-8-4N	372HB-8-4PP	1/2	1/4	.55	9/16	2.52	1.17	.37
372HB-8-6N	372HB-8-6PP	1/2	3/8	.56	11/16	2.52	1.17	.37
372HB-8-8N	372HB-8-8PP	1/2	1/2	.55	7/8	2.52	1.30	.37
372HB-12-12N	372HB-12-12PP	3/4	3/4	.81	1-1/8	2.97	1.92	.58
372HB-16-8N		1	1/2	1.07	7/8	3.10	1.74	.81
372HB-16-12N		1	3/4	1.07	1-1/8	3.10	1.92	.81
372HB-16-16N		1	1	1.07	1-3/8	3.11	1.98	.81



Male Elbow 329HB

WHITE NYLON PART NO.	BLACK POLYPROPYLENE PART NO.	TUBE OR HOSE I.D.	NPT PIPE THD.	O.D.	C HEX	M	N	FLOW DIA. D
329HB-3-2N	329HB-3-2PP	3/16	1/8	.25	7/16	.76	1.06	.12
329HB-3-4N		3/16	1/4	.25	9/16	.76	1.17	.13
329HB-4-2N	329HB-4-2PP	1/4	1/8	.31	7/16	1.18	1.04	.16
329HB-4-4N	329HB-4-4PP	1/4	1/4	.31	9/16	1.18	1.16	.22
329HB-4-6N	329HB-4-6PP	1/4	3/8	.31	11/16	1.18	1.17	.15
329HB-4-8N	329HB-4-8PP	1/4	1/2	.32	7/8	1.18	1.30	.15
329HB-5-2N		5/16	1/8	.37	7/16	1.18	1.06	.22
329HB-6-2N	329HB-6-2PP	3/8	1/8	.43	7/16	1.18	1.05	.25
329HB-6-4N	329HB-6-4PP	3/8	1/4	.43	9/16	1.18	1.16	.25
329HB-6-6N	329HB-6-6PP	3/8	3/8	.43	11/16	1.17	1.17	.25
329HB-6-8N	329HB-6-8PP	3/8	1/2	.43	7/8	1.18	1.28	.25
329HB-8-4N	329HB-8-4PP	1/2	1/4	.55	9/16	1.27	1.16	.37
329HB-8-6N	329HB-8-6PP	1/2	3/8	.56	11/16	1.26	1.16	.37
329HB-8-8N	329HB-8-8PP	1/2	1/2	.55	7/8	1.25	1.29	.37
329HB-8-12N	329HB-8-12PP	1/2	3/4	.55	1-1/8	1.30	1.89	.37
329HB-10-6N		5/8	3/8	.67	11/16	1.27	1.18	.47
329HB-10-8N	329HB-10-8PP	5/8	1/2	.68	7/8	1.30	1.73	.48
329HB-10-12N	329HB-10-12PP	5/8	3/4	.69	1-1/8	1.32	1.92	.49
329HB-12-8N	329HB-12-8PP	3/4	1/2	.81	7/8	1.51	1.74	.58
329HB-12-12N	329HB-12-12PP	3/4	3/4	.81	1-1/8	1.50	1.91	.58
329HB-12-16N		3/4	1	.82	1-3/8	1.49	1.98	.58
329HB-12-20N		3/4	1-1/4	.86	1-1/2	1.52	2.39	.59
329HB-12-24N		3/4	1-1/2	.85	1-1/2	2.26	3.09	.59
329HB-16-8N		1	1/2	1.12	7/8	1.58	1.78	.86
329HB-16-12N		1	3/4	1.11	1-1/8	1.58	1.93	.86
329HB-16-16N		1	1	1.08	1-3/8	1.55	1.98	.81
329HB-16-20N		1	1-1/4	1.12	1-1/2	2.28	2.93	.84
329HB-16-24N		1	1-1/2	1.12	1-1/2	2.27	3.11	.84
329HB-20-20N		1-1/4	1-1/4	1.25	1-1/2	2.63	2.94	1.00
329HB-20-24N		1-1/4	1-1/2	1.36	1-1/2	2.63	3.11	1.08
329HB-24-20N		1-1/2	1-1/4	1.60	1-1/2	2.77	2.93	1.30
329HB-24-24N		1-1/2	1-1/2	1.60	1-1/2	2.77	3.10	1.30

Female Elbow 370HB

WHITE NYLON PART NO.	BLACK POLYPROPYLENE PART NO.	TUBE OR HOSE I.D.	NPT PIPE THD.	O.D.	C HEX	M	N	FLOW DIA. D
370HB-4-2N	370HB-4-2PP	1/4	1/8	.31	5/8	1.19	1.07	.16
370HB-4-4N	370HB-4-4PP	1/4	1/4	.31	3/4	1.18	1.08	.16
370HB-4-6N	370HB-4-6PP	1/4	3/8	.31	1	1.16	1.30	.16
370HB-4-8N	370HB-4-8PP	1/4	1/2	.31	1-1/8	1.18	1.30	.15
370HB-6-2N	370HB-6-2PP	3/8	1/8	.43	5/8	1.18	1.06	.25
370HB-6-4N	370HB-6-4PP	3/8	1/4	.44	3/4	1.18	1.06	.25
370HB-6-6N	370HB-6-6PP	3/8	3/8	.43	1	1.18	1.29	.25
370HB-6-8N	370HB-6-8PP	3/8	1/2	.43	1-1/8	1.18	1.29	.25
370HB-8-4N	370HB-8-4PP	1/2	1/4	.55	3/4	1.25	1.22	.37
370HB-8-6N	370HB-8-6PP	1/2	3/8	.55	1	1.25	1.44	.37
370HB-8-8N	370HB-8-8PP	1/2	1/2	.55	1-1/8	1.25	1.45	.37
370HB-8-12N	370HB-8-12PP	1/2	3/4	.55	1-3/8	1.26	1.72	.37
370HB-12-12N	370HB-12-12PP	3/4	3/4	.80	1-3/8	1.38	1.84	.59

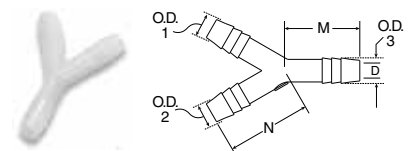

Union Y 362HB

WHITE NYLON PART NO.	TUBE OR HOSE I.D. 1 & 2	TUBE OR HOSE I.D. 3	O.D. 1 & 2	O.D. 3	M	N	FLOW DIA. D
362HB-4N	1/4	1/4	.31	.31	1.13	1.13	.16
362HB-6N	3/8	3/8	.43	.43	1.25	1.40	.25
362HB-8N	1/2	1/2	.55	.55	1.25	1.50	.38

WARNING These products can expose you to chemicals including NICKEL, CARBON BLACK, TITANIUM DIOXIDE, or LEAD, which are known to the state of California to cause cancer, and LEAD which is known to cause birth defects or other reproductive harm. For more information go to www.P65Warnings.ca.gov.



Ball Nose Hose Barb Stem 328HB

WHITE NYLON PART NO.	BLACK POLYPROPYLENE PART NO.	TUBE OR HOSE I.D.	SWIVEL NUT NPT PIPE THREAD	O.D.	L	FLOW DIA. D
328HB-4BN	328HB-4BPP	1/4	1/4 *	.30	1.19	.19
328HB-4-8BN	328HB-4-8BPP	1/4	1/2 *	.30	1.29	.15
328HB-6BN	328HB-6BPP	3/8	3/8 *	.56	1.41	.25
328HB-8BN	328HB-8BPP	1/2	1/2 *	.67	1.30	.37

*Use with hose barb swivel nut (31HB-XX) for desired NPT thread.



Hose Barb Swivel Nut 31HB

WHITE NYLON PART NO.	BLACK POLYPROPYLENE PART NO.	NPT PIPE THREAD	C HEX	L
31HB-4N	31HB-4PP	1/4	3/4	.62
31HB-6N	31HB-6PP	3/8	7/8	.63
31HB-8N	31HB-8PP	1/2	1- 1/16	.75

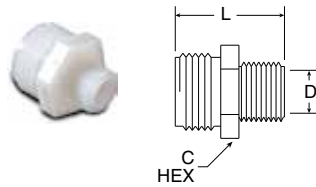

Male Garden Hose - Male Pipe Adapter 316GH

WHITE NYLON PART NO.	GARDEN HOSE THREAD	NPT PIPE THREAD	C HEX	L	FLOW DIA. D
316GH-12-6N	3/4	3/8	1- 1/8	1.33	.44
316GH-12-8N	3/4	1/2	1- 1/8	1.44	.59
316GH-12-12N	3/4	3/4	1- 1/8	1.48	.75

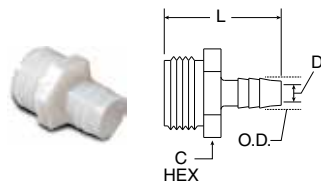

Male Garden Hose - Hose Barb 325GH

WHITE NYLON PART NO.	TUBE OR HOSE I.D.	GARDEN HOSE THREAD	O.D.	C HEX	L	FLOW DIA. D
325GH-4-12N	1/4	3/4	.31	1- 1/8	1.70	.16
325GH-6-12N	3/8	3/4	.44	1- 1/8	1.69	.25
325GH-8-12N	1/2	3/4	.55	1- 1/8	1.68	.38
325GH-10-12N	5/8	3/4	.64	1- 1/8	1.70	.47
325GH-12-12N	3/4	3/4	.81	1- 1/8	1.70	.62

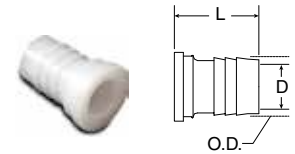

Garden Hose Swivel Hose Barb Stem 325GHSV

WHITE NYLON PART NO.	TUBE OR HOSE I.D.	GARDEN HOSE THREAD	O.D.	L	FLOW DIA. D
325GHSV-4-12BN*	1/4	3/4	.31	1.16	.16
325GHSV-6-12BN*	3/8	3/4	.44	1.17	.25
325GHSV-8-12BN*	1/2	3/4	.56	1.17	.38
325GHSV-10-12BN*	5/8	3/4	.64	1.18	.47
325GHSV-12-12BN*	3/4	3/4	.81	1.18	.62

*Use with Garden Hose washer (30GH-12) and Garden Hose Nut (31GH-12N)

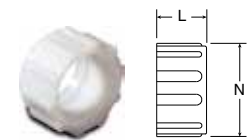

Garden Hose Nut 31GH

WHITE NYLON PART NO.	GARDEN HOSE THREAD	L	DIA. N
31GH-12N	3/4	.74	1.38

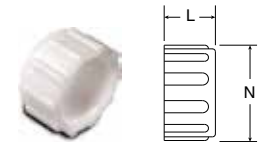

Garden Hose Cap 313GH

WHITE NYLON PART NO.	GARDEN HOSE THREAD	L	DIA. N
313GH-12N**	3/4	.74	1.38

**Use with Garden Hose Washer (30GH-12)



Garden Hose Washer 30GH

WHITE TPE PART NO.	GARDEN HOSE THREAD	L
30GH-12	3/4	.13

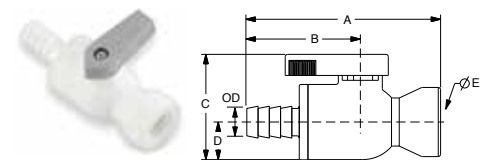

VFC - Valve Barbed Female Connector

PART NO.	HOSE I.D.	NPTF THD.	O.D.	A	B	C	D	ØE THRU HOLE MIN.
PBPP4VFC4	1/4	1/4	.31	2.76	1.60	1.41	.50	.15
PBPP6VFC6	3/8	3/8	.43	2.79	1.60	1.41	.50	.19

WARNING These products can expose you to chemicals including NICKEL, CARBON BLACK, TITANIUM DIOXIDE, or LEAD, which are known to the state of California to cause cancer, and LEAD which is known to cause birth defects or other reproductive harm. For more information go to www.P65Warnings.ca.gov.

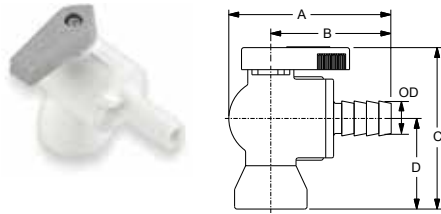

VFE - Valve Barbed Female Elbow

PART NO.	HOSE I.D.	NPTF THD.	O.D.	A	B	C	D	ØE THRU HOLE MIN.
PBPP4VFE4	1/4	1/4	.31	2.13	1.60	2.05	1.15	.15
PBPP6VFE4	3/8	1/4	.43	2.13	1.60	2.05	1.15	.15
PBPP6VFE6	3/8	3/8	.43	2.13	1.60	2.18	1.28	.19

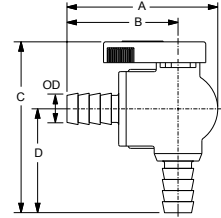

VEU - Parbarb Elbow Ball Valve

PART NO.	HOSE I.D.	O.D.	A	B	C	D	ØE THRU HOLE MIN.
PBPP4VEU4	1/4	.31	2.13	1.57	2.32	1.40	.15
PBPP6VEU6	3/8	.43	2.13	1.60	2.32	1.40	.25
PBPP8VEU8	1/2	.55	2.13	1.60	2.32	1.40	.25

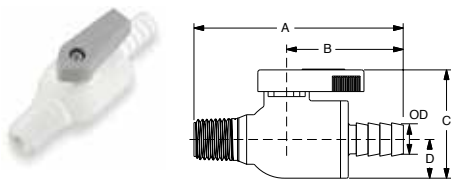

VMC - Valve Barbed Male Connector

PART NO.	HOSE I.D.	NPTF THD.	O.D.	A	B	C	D	ØE THRU HOLE MIN.
PBPP4VMC4	1/4	1/4	.31	2.79	1.60	1.42	.50	.15
PBPP6VMC6	3/8	3/8	.43	2.79	1.60	1.42	.50	.19

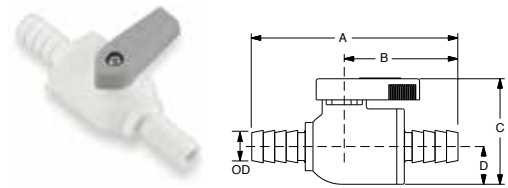

VUC - Valve Barbed Union Connector

PART NO.	HOSE I.D.	O.D.	A	B	C	D	ØE THRU HOLE MIN.
PBPP4VUC4	1/4	.31	2.91	1.60	1.42	.50	.15
PBPP6VUC6	3/8	.43	2.91	1.60	1.42	.50	.19
PBPP8VUC8	1/2	.55	2.91	1.60	1.42	.50	.25

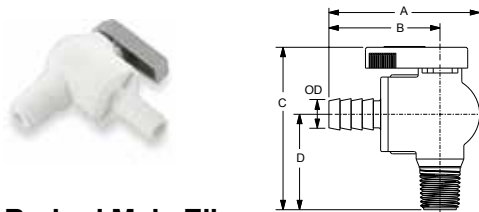

VME - Valve Barbed Male Elbow

PART NO.	HOSE I.D.	NPTF THD.	O.D.	A	B	C	D	ØE THRU HOLE MIN.
PBPP4VME4	1/4	1/4	.31	2.13	1.60	2.18	1.28	.15
PBPP6VME6	3/8	3/8	.43	2.13	1.60	2.18	1.28	.19

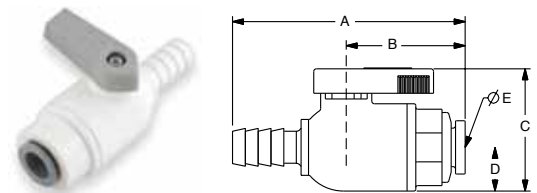

VUCPB - Valve Union Connector Barbed x Tube

PART NO.	HOSE ID	TUBE OD	OD	A	B	C	D	ØE THRU HOLE MIN.
LFPP4VUCPB4	1/4	1/4	.31	2.40	1.08	1.42	.50	.15
LFPP6VUCPB6	3/8	3/8	.43	2.63	1.32	1.42	.50	.19

WARNING These products can expose you to chemicals including NICKEL, CARBON BLACK, TITANIUM DIOXIDE, or LEAD, which are known to the state of California to cause cancer, and LEAD which is known to cause birth defects or other reproductive harm. For more information go to www.P65Warnings.ca.gov.





Cartridges

Carstick® Cartridges

LIQUIfit® Cartridges

TrueSeal™ Cartridges

PLM/PLS Cartridges

PMT Cartridges





Cartridges



Parker has developed a range of cartridges guaranteeing the integrity of the sealing system before and after assembly in non-threaded cavities. The compact design of the one-piece cartridges enables automation of your manufacturing process and improves the reliability of your system.

Product Features:

- Self-centering of the cartridge in the cavity
- Push-in connection
- Designed for automation assembly process
- SAE & NSF cartridges available

Markets:

- Industrial
- Pneumatic
- Filtration
- Semi-Conductor
- Life Science
- Automation
- Heavy Duty Truck

Applications:

- Air
- Water
- Beverage Dispensing
- Cab Controls
- Packaging
- Labeling









Specifications:

	Pressure	Temperature
Carstick	Up to 290 PSI (20 bar)	-4° to +175° F (-20° to +79.4° C)
PLM/PLS	Up to 435 PSI (30 bar)	-4° to +302° F (-20° to +150° C)
LIQUIfit	Up to 230 PSI (15.9 bar)	35° to +200° F (+1.7° to +93.3° C)
TrueSeal	Up to 150 PSI (10.3 bar)	-20° to +180° F (-28.9° to +82.2° C)
SAE Encapsulated	Up to 250 PSI (17.2 bar)	-40° to +200° F (-40° to +93.3° C)

WARNING These products can expose you to chemicals including NICKEL or LEAD, which are known to the state of California to cause cancer, and LEAD which is known to cause birth defects or other reproductive harm. For more information go to www.P65Warnings.ca.gov.



Cartridge

 3100 Carstick® Cartridge Brass p. D6	 3100 Carstick® Cartridge Nickel-Plated Brass p. D6	 6300 LIQUIfit Cartridge Brass p. D8	 6300 LIQUIfit Cartridge Nickel-Plated Brass p. D8	 TSC Cartridge Insert p. D10	 PLMC Cartridge p. D11
 PLSC Cartridge p. D11	 PMTCE Encapsulated p. D12				

WARNING These products can expose you to chemicals including NICKEL or LEAD, which are known to the state of California to cause cancer, and LEAD which is known to cause birth defects or other reproductive harm. For more information go to www.P65Warnings.ca.gov.

Carstick® Cartridges

Component Materials

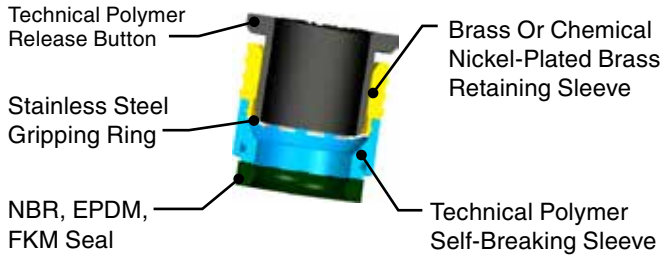

3100 Carstick® Cartridge Brass

PART NO.	OD	G	G1	H	L	KG
3100 04 00	4	8	11	10	554	.001
3100 06 00	6	10	14.5	11.5	629	.002
3100 08 00	8	13	15	15	794	.002
3100 10 00	10	15.5	19.5	17	930	.005
3100 12 00	12	19.5	21	19.5	1038	.010

50 cartridges per Carstick®

3100 Carstick® Cartridge Nickel-Plated Brass Inch

PART NO.	OD	G	G1	H	L	KG
3100 53 00 99	1/8	7	10	9	508	.002
3100 56 00 99	1/4	10.5	14.5	12	600	.003
3100 60 00 99	3/8	15.5	19	16.5	930	.006

50 cartridges per Carstick®
5/32" (4mm) and 5/16" (8mm) also available

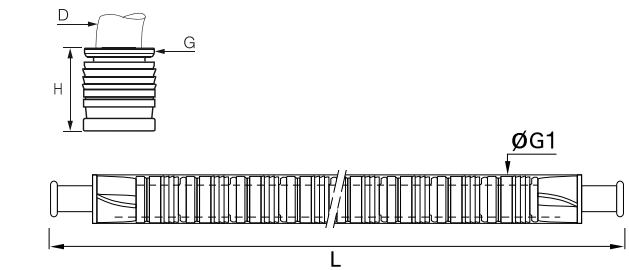
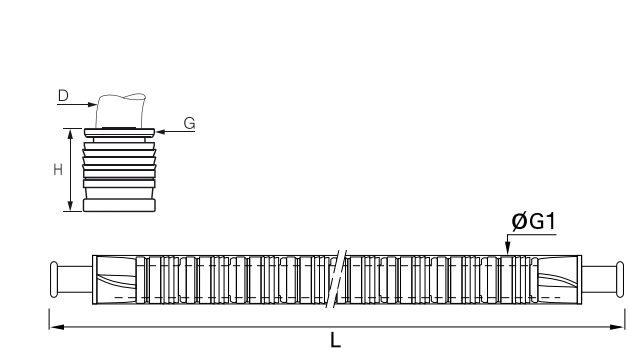

Installation

1. Self-centering of the cartridge in the cavity.
2. The seal protection is broken. The seal slides into the cavity. The cartridge is in place.
3. Tube connection.

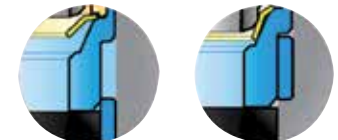
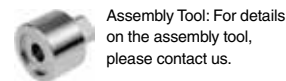
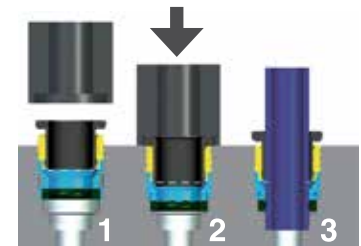

WARNING These products can expose you to chemicals including NICKEL or LEAD, which are known to the state of California to cause cancer, and LEAD which is known to cause birth defects or other reproductive harm. For more information go to www.P65Warnings.ca.gov.

Carstick® Cavity Dimensions

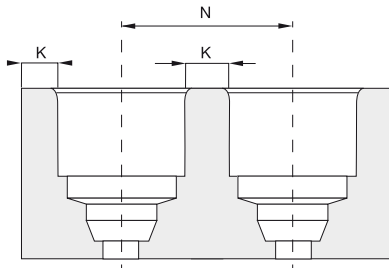
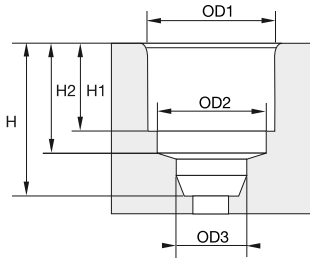

Please consult us for detailed drawings of cavity dimensions and tolerances. All our dimensions are in millimeters.

Carstick® & Quick Fitting Metric

CAVITY	OD3	H	H1	H2
4	4.1	10	6	8.15
6	6.1	12	7.5	9.65
8	8.15	15.5	9.9	12.45
10	10.25	19	11.7	14.35
12	12.17	22	13.9	16.75

Carstick® Inch

CAVITY	OD3	H	H1	H2
1/8	3.25	7.45	5.3	9.5
5/32 *	4.1	8.15	6	10
1/4	6.45	10.15	8	12.5
5/16 *	8.15	12.45	9.9	15.5
3/8	9.65	14.35	11.7	19

Polyamide Cavity

CAVITY	OD1	OD2	N*	K
4	8.25	7.05	9.8	1.5
6	10.2	9.15	12.2	2
8	12.15	10.85	14.2	2
10	14.8	13.2	16.8	2
12	17.5	15.5	20	2.5

CAVITY	OD1	OD2	N	K
1/8	7.05	6.02	8.6	1.5
5/32*	8.25	7.05	9.75	1.5
1/4	10.55	9.35	12.6	2
5/16*	12.15	10.85	14.2	2
3/8	14.8	13.1	16.8	2

Aluminum Cavity

CAVITY	OD1	OD2	N*	K
4	8.25	7.5	11.5	3
6	10.3	9.15	13.5	3
8	12.2	10.85	15.2	3
10	15.05	13.2	17.1	2
12	17.5	15.5	20	2.5

CAVITY	OD1	OD2	N	K
1/8	7.1	6.2	8.6	1.5
5/32*	8.25	7.05	11.25	3
1/4	10.6	9.35	12.65	2
5/16*	12.2	10.85	15.2	3
3/8	15.05	13.1	17.1	2

Brass Cavity

CAVITY	OD1	OD2	N*	K
4	8.25	7.05	10.25	2
6	10.25	9.1	12.25	2
8	12.2	10.85	14.25	2
10	15.05	13.2	17.1	2
12	17.65	15.5	20	2.5

CAVITY	OD1	OD2	N	K
1/8	7.1	6.2	8.6	1.5
5/32*	8.25	7.05	10.25	2
1/4	10.6	9.35	12.65	2
5/16*	12/2	10.85	14.25	2
3/8	10.05	13.1	17.1	2

* Carstick®

*5/32"=4mm and 5/16"=8mm

LIQUIfit® Cartridges



6300 LIQUIfit Cartridge Brass Metric

PART NO.	OD	G	G1	H	L	KG
6300 04 00	4	8	11	10	554	.002
6300 06 00	6	10	14.5	11.5	629	.002
6300 08 00	8	13	15	15	794	.003
6300 10 00	10	15.5	19.5	17	930	.005
6300 12 00	12	18.5	21	19.5	1038	.010

50 cartridges per Carstick®

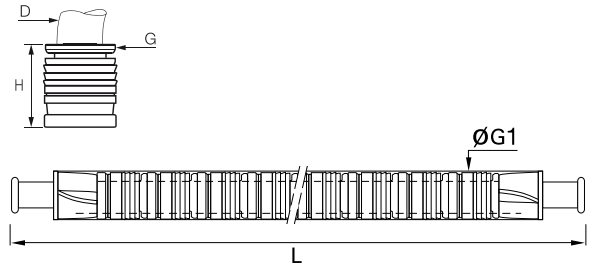

6300 LIQUIfit Cartridge Brass Inch

PART NO.	OD	G	G1	H	L	KG
6300 56 00	1/4	10.5	14.5	12.5	600	.002
6300 60 00	3/8	15.5	19	17	930	.005
6300 62 00	1/2	22	25	23	1038	.011

50 cartridges per Carstick®
5/32" (4mm) and 5/16" (8mm) also available

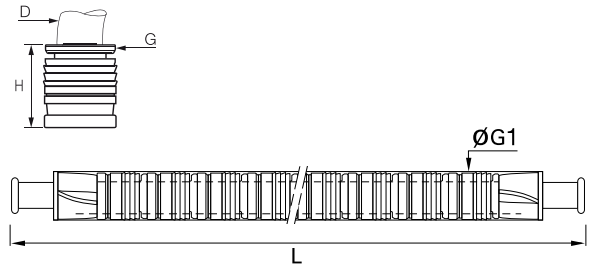

Installation

1. Self-centering of the cartridge in the cavity.
2. The seal protection is broken. The seal slides into the cavity. The cartridge is in place.
3. Tube connection.

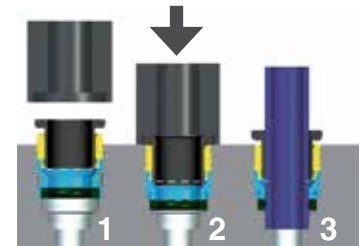

Assembly Tool: For details on the assembly tool, please contact us.



WARNING These products can expose you to chemicals including NICKEL or LEAD, which are known to the state of California to cause cancer, and LEAD which is known to cause birth defects or other reproductive harm. For more information go to www.P65Warnings.ca.gov.

LIQUIfit® Carstick® Cavity Dimensions

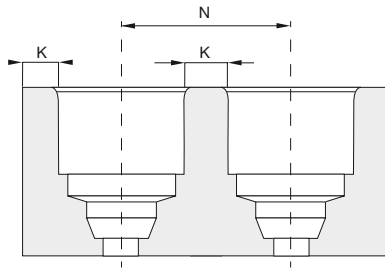
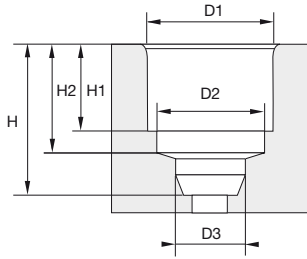

Please consult us for detailed drawings of cavity dimensions and tolerances. All our dimensions are in millimeters.

LIQUIfit® Carstick® Metric

CAVITY	OD3	H	H1	H2
4	4.1	10	6	8.15
6	6.1	12	7.5	9.65
8	8.15	15.5	9.9	12.45
10	10.25	19	11.7	14.35
12	12.17	22	13.9	16.75

LIQUIfit® Carstick® Inch

CAVITY	OD3	H	H1	H2
1/8	3.25	7.45	5.3	9.5
5/32*	4.1	8.15	6	10
1/4	6.45	10.15	8	12.5
5/16*	8.15	12.45	9.9	15.5
3/8	9.65	14.35	11.7	19

Polyamide Cavity

CAVITY	OD1	OD2	N*	K
4	8.25	7.05	9.8	1.5
6	10.2	9.15	12.2	2
8	12.15	10.85	14.2	2
10	14.8	13.2	16.8	2
12	17.5	15.5	20	2.5

CAVITY	OD1	OD2	N	K
1/8	7.05	6.02	8.6	1.5
5/32*	8.25	7.05	9.75	1.5
1/4	10.55	9.35	12.6	2
5/16*	12.15	10.85	14.2	2
3/8	14.8	13.1	16.8	2

Aluminum Cavity

CAVITY	OD1	OD2	N*	K
4	8.25	7.5	11.5	3
6	10.3	9.15	13.5	3
8	12.2	10.85	15.2	3
10	15.05	13.2	17.1	2
12	17.5	15.5	20	2.5

CAVITY	OD1	OD2	N	K
1/8	7.1	6.2	8.6	1.5
5/32*	8.25	7.05	11.25	3
1/4	10.6	9.35	12.65	2
5/16*	12.2	10.85	15.2	3
3/8	15.05	13.1	17.1	2

Brass Cavity

CAVITY	OD1	OD2	N*	K
4	8.25	7.05	10.25	2
6	10.25	9.1	12.25	2
8	12.2	10.85	14.25	2
10	15.05	13.2	17.1	2
12	17.65	15.5	20	2.5

CAVITY	OD1	OD2	N	K
1/8	7.1	6.2	8.6	1.5
5/32*	8.25	7.05	10.25	2
1/4	10.6	9.35	12.65	2
5/16*	12.2	10.85	14.25	2
3/8	10.05	13.1	17.1	2

*5/32"=4mm and 5/16"=8mm

WARNING These products can expose you to chemicals including NICKEL or LEAD, which are known to the state of California to cause cancer, and LEAD which is known to cause birth defects or other reproductive harm. For more information go to www.P65Warnings.ca.gov.

TrueSeal™ Cartridges



TSC - Cartridge Insert

PART NUMBER WITH EPDM SEAL	NOM. TUBE O.D.	A* DIAMETER ±002	B DIAMETER ±003	C DIAMETER ±003	D DIAMETER MAXIMUM	E DEPTH ±002	F DEPTH ±002	G DEPTH ±002	H* CENTERLINE OF PORTS MINIMUM
ATSC4-MG	1/4	.528	.421	.260	.19	.230	.435	.600	.670
ATSC6-MG	3/8	.632	.545	.385	.31	.280	.455	.705	.790
ATSC8-MG	1/2	.774	.668	.510	.41	.315	.510	.810	1.250

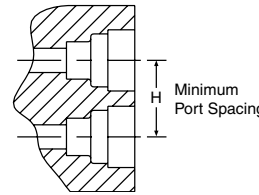
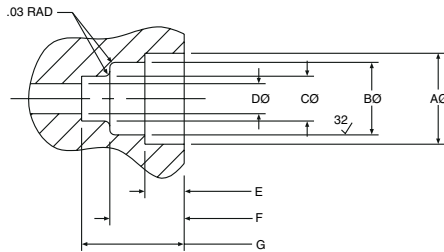

Parker TrueSeal™ Cartridge Inserts:

Allow you to machine or mold a tube connection into your equipment or components. By using cartridge inserts, you will reduce your material and assembly costs, reduce potential leak paths, and give your equipment a new, clean profile by eliminating the need for threaded connections. TSC Cartridge Inserts consist of 1 o-ring, 1 cartridge, and 1 collet.

*Cartridge inserts are rated at 150 PSI in ports dimensioned as above and having Noryl as the receiving material. Other materials may have different ratings and require different port dimensions. Consult the Fluid System Connectors Division when using polypropylene, unfilled polypropylene, ABS or Nylon.

Assembly Instructions:

1. Machine or mold the receiving orifice as per the above dimensions.
2. Place the cartridge insert squarely onto the prepared port opening making sure that the barbs of the cartridge are going into the hole and the lettering on the face of the cartridge is visible.
3. Using a rubber mallet or press, insert the cartridge into the first gland orifice until its face is flush with the top surface of the port.
4. Insert the o-ring into the cartridge and seat it evenly into the second gland orifice.
5. Insert the collet into the cartridge opening.
6. Insert tubing.

WARNING These products can expose you to chemicals including NICKEL or LEAD, which are known to the state of California to cause cancer, and LEAD which is known to cause birth defects or other reproductive harm. For more information go to www.P65Warnings.ca.gov.



PLM/PLS Cartridges

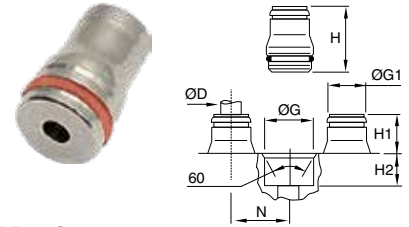
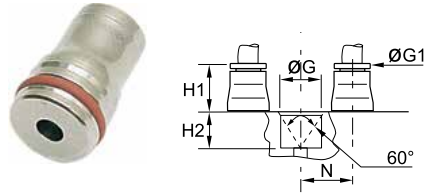

PLMC Cartridge

PART NO.	TUBE SIZE MM	G + .1 - 0	H1 MM	H2 MM	N MM
PLMC-4M	4	10.00	9.00	8.50	11.00
PLMC-6M	6	12.00	11.00	8.50	13.50
PLMC-8M	8	15.00	12.50	8.50	16.00
PLMC-10M	10	17.50	14.50	10.50	20.00
PLMC-12M	12	19.50	15.00	10.50	22.50
PLMC-14M	14	21.50	16.50	12.00	25.00

PLSC Cartridge - Metric

PART NO.	TUBE SIZE MM	G + .1 - 0 MM	G1 MM	H MM	H1 MM	H2 MM	N MM
PLSC-4M	4	9.80	8	18.00	9.50	8.50	11.00
PLSC-6M	6	12.10	10	20.00	11.50	8.50	13.50
PLSC-8M	8	14.80	13	22.00	13.50	8.50	16.00
PLSC-10M	10	17.50	15	25.50	15.00	10.50	20.00

WARNING These products can expose you to chemicals including NICKEL or LEAD, which are known to the state of California to cause cancer, and LEAD which is known to cause birth defects or other reproductive harm. For more information go to www.P65Warnings.ca.gov.



PMT Cartridges

Prestomatic SAE Encapsulated Cartridge PMCE/PMTCE

PART NO.	TUBE SIZE	CAVITY SIZE $\pm .002$	L	M	O.D.	FLOW DIA. D
PMTCE-4	1/4	.504	.64	.44	.56	.140
PMTCE-4-8	1/4	.775	.66	.42	.87	.140
PMTCE-6	3/8	.650	.84	.64	.75	.217
PMTCE-6-8	3/8	.775	.84	.64	.87	.217
PMTCE-8	1/2	.775	.98	.77	.87	.338
PMTCE-10	5/8	.925	1.07	.86	1.00	.398

NOMINAL TUBE OD (IN)	D1 (MM) $\pm .05$	D1 (IN) $\pm .002$	L1 (MM) MIN	L1 (IN) MIN	R1 (MM) $\pm .05$	R1 (IN) $\pm .002$	R2 (MM) $\pm .05$	R2 (IN) $\pm .002$	C1 (MM) $\pm .05$	C1 (IN) $\pm .002$
1/4	12.8	.504	12.7	.5	.5	.02	.5	.02	.5	.02
3/8	16.5	.65	16.5	.65	.5	.02	.5	.02	.5	.02
1/2	19.7	.775	19.8	.78	.5	.02	.5	.02	.5	.02
5/8	23.5	.925	22.4	.88	.8	.03	.5	.02	.8	.03

Cavity material is to be 6061 T6 aluminum

Cavity Specifications

Dimensions are per the SAE Standard J2494-4. The SAE Encapsulated Cartridge is thoroughly tested to meet or exceed the performance requirements of D.O.T. FMVSS 571.106 and SAE J1131 when used in a 6061-T6 aluminum cavity per SAE J2494-4. Cavity dimensions specified by SAE J2494-4 need to be adjusted slightly for optimum performance in material other than 6061-T6.

Installation

Apply force evenly over the top surface of the cartridge body until the cartridge shoulder bottoms out on the top of the cavity. The amount of force required will vary depending on the cartridge size and the material of the cavity.

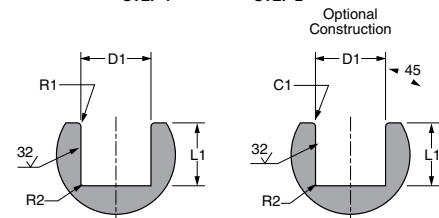
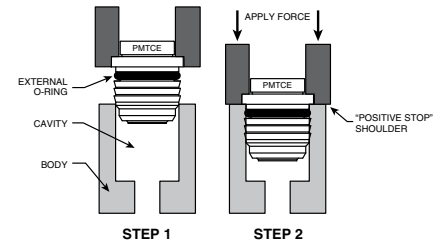
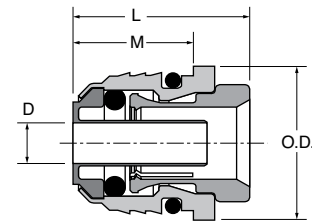

WARNING These products can expose you to chemicals including NICKEL or LEAD, which are known to the state of California to cause cancer, and LEAD which is known to cause birth defects or other reproductive harm. For more information go to www.P65Warnings.ca.gov.



Transportation Push-to-Connect

PTC & PTCR Composite

Brass PTC

Prestomatic Fittings

Metric Prestomatic Fittings























PMH Fittings





Tube to Male NPT	68PMT Male Connector  p. E14	169PMT Male Elbow  p. E15	169PMTR Male Elbow Positional  p. E15	169PMTL Male Elbow Long  p. E15	169PMTNS Male Elbow Rigid  p. E15	171PMT Run Tee Swivel  p. E16
	171PMTNS Run Tee Rigid  p. E16	172PMT Branch Tee Swivel  p. E16	172PMTNS Branch Tee Rigid  p. E16	179PMT 45° Male Elbow Swivel  p. E17	179PMTR 45° Male Elbow Positional  p. E17	179PMTNS 45° Male Elbow Rigid  p. E17
VS369PTCR Male Elbow  p. E7	VS368PTC Male Y Connector  p. E7	VS371PTCR Run Tee  p. E8	VS372PTCR Branch Tee  p. E8	VS379PTCR 45° Male Elbow  p. E8	Tube to Female NPT	66PMT Female Connector  p. E13
170PMT Female Elbow Swivel  p. E16	170PMTNS Female Elbow Rigid  p. E16	370PTC Female Elbow  p. E7	377PTC Female Branch Tee  p. E8	Tube to Straight Thread		685PMH Male Connector  p. E21
1715PMH Male Run Tee  p. E21	1725PMH Male Branch Tee  p. E21	Tube to Metric Thread	68PMT-X-M Male Connector  p. E14		169PMTNS-X-M Male Elbow Rigid  p. E15	
Tube to Tube	62PMT Union  p. E13		164PMT Union Tee  p. E14	165PMT Union Elbow  p. E14	32PTC Union  p. E7	362PTC Union Y  p. E7
	365PTC Union Elbow  p. E7	Bulkhead Union	62PMTBHR Retaining Ring Bulkhead  p. E13	62PMTBH Bulkhead Union  p. E13	66PMTBH Female Bulkhead Union  p. E14	68PMTBH Male Bulkhead Union  p. E14
169PMTBH Male Elbow Bulkhead  p. E15	Plug-ins		37PTCSP Adapter  p. E8	369PTCSP Male Elbow  p. E8	372PTCSP Branch Tee  p. E9	371PTCSP Run Tee  p. E9

WARNING These products can expose you to chemicals including NICKEL or LEAD, which are known to the state of California to cause cancer, and LEAD which is known to cause birth defects or other reproductive harm. For more information go to www.P65Warnings.ca.gov.

Auxiliary Component	ERHD External Retainer	ES External Seal	639PLP Plug			
						
	p. E13	p. E13	p. E17			
Metric Tube to Metric Straight Thread	F8UPMTB Male Connector	C8UPMTB Male Elbow	S8UPMTB Branch Tee	Metric Tube to Metric Tube	HPMTB Union	JPMTB Union Tee
						
p. E19	p. E19	p. E19	p. E19	p. E19	p. E19	
Metric Tube to NPT	F2PMTB Male Connector	Manifolds	24M Presto Manifold			
						
p. E19		p. E9				
Brass PTC	62PTC Union	66PTC Female Connector	66PTC Female Connector	68PTC Male Connector	VS68PTCR Male Connector	164PTC Union Tee
						
p. E10	p. E10	p. E10	p. E10	p. E10	p. E10	p. E11
165PTC Union Elbow	169PTCNS Male Elbow	171PTCNS Male Run Tee	172PTCNS Male Branch Tee			
						
p. E11	p. E11	p. E11	p. E11			
Safe Lock	A613, A614 Safe Lock Straight	A623, A624 Safe Lock Elbow	68ALS Brass Adapter			
						
p. E23	p. E23	p. E23				

WARNING These products can expose you to chemicals including NICKEL or LEAD, which are known to the state of California to cause cancer, and LEAD which is known to cause birth defects or other reproductive harm. For more information go to www.P65Warnings.ca.gov.

PTC & PTCR Composite



Parker's PTC & PTCR Fitting is a composite push-to-connect fitting that meets SAE and D.O.T. specifications. Designed for all D.O.T truck and trailer applications, Parker PTC fittings reduce assembly time versus compression style fittings .

Product Features:

- Brass Collet
- Buna N O-ring
- Stainless Steel Tube Support
- Meets D.O.T. FMVSS571.106
- Meets SAE J2494-3
- Composite Body – Strong, Lightweight, Compact and Impact Resistant
- Plug-in configurations

Markets:

- Heavy Duty Truck
- Trailer
- Mobile

Applications:

- Air Brakes
- Air Tanks
- Air Ride
- Sliders
- Tire Inflation
- Primary & Secondary Air Lines
- Cab Controls

Specifications:

Pressure Range Up to 250 PSI (17.2 bar)

Temperature Range -40° to +200° F (-40° to +93.3° C)

Compatible Tubing:

- SAE J844 Type A & B nylon tubing



Assembly Instructions

1. Cut tubing squarely – maximum of 15° angle allowable.
2. Check that port or mating part is clean and free of debris.
3. Mark tubing to appropriate tube insertion length. (see Tube Insertion Chart on page N22)
4. Insert tubing until it bottoms
5. Pull on tubing to verify it is fully inserted
6. To disassemble, simply press release button, hold against body and pull tubing out of fitting.

WARNING These products can expose you to chemicals including LEAD which is known to the state of California to cause cancer and birth defects or other reproductive harm. For more information go to www.P65Warnings.ca.gov.



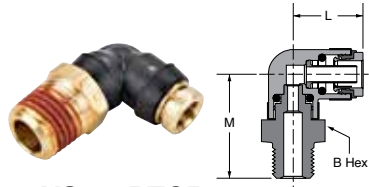

Male Elbow Swivel 90° VS369PTCR

PART NO.	TUBE SIZE	PIPE THREAD	B HEX	L	M
VS369PTCR-4-2	1/4	1/8	9/16	.74	1.00
VS369PTCR-4-4	1/4	1/4	9/16	.74	1.14
VS369PTCR-4-6	1/4	3/8	11/16	.74	1.14
VS369PTCR-6-2	3/8	1/8	3/4	1.01	1.13
VS369PTCR-6-4	3/8	1/4	3/4	1.01	1.28
VS369PTCR-6-6	3/8	3/8	3/4	1.01	1.28
VS369PTCR-6-8	3/8	1/2	7/8	1.01	1.49
VS369PTCR-8-4	1/2	1/4	15/16	1.13	1.42
VS369PTCR-8-6	1/2	3/8	15/16	1.13	1.42
VS369PTCR-8-8	1/2	1/2	15/16	1.13	1.61
VS369PTCR-10-6	5/8	3/8	1-1/16	1.36	1.61
VS369PTCR-10-8	5/8	1/2	1-1/16	1.36	1.80
VS369PTCR-12-8	3/4	1/2	1-3/16	1.47	1.92

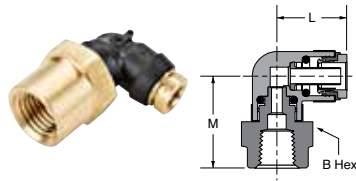

Female Elbow Swivel 90° 370PTCR

PART NO.	TUBE SIZE	PIPE THREAD	B HEX	L	M
370PTCR-4-2	1/4	1/8	5/8	.74	.98
370PTCR-4-4	1/4	1/4	3/4	.74	1.20
370PTCR-6-2	3/8	1/8	3/4	1.01	.75
370PTCR-6-4	3/8	1/4	3/4	1.01	1.04
370PTCR-6-6	3/8	3/8	3/4	1.01	1.19
370PTCR-8-6	1/2	3/8	3/4	1.13	1.24
370PTCR-8-8	1/2	1/2	15/16	1.13	1.49

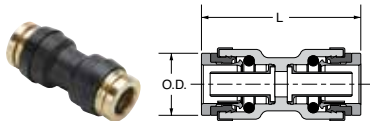

Union 32PTC

PART NO.	TUBE SIZE	L	O.D.
32PTC-4	1/4	1.33	.53
32PTC-6	3/8	1.61	.73
32PTC-8	1/2	1.75	.88
32PTC-10	5/8	2.15	1.02
32PTC-12	3/4	2.50	1.17

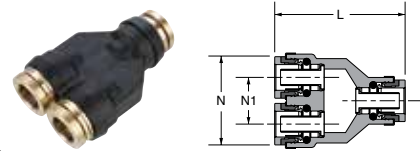

Union Y 362PTC

PART NO.	TUBE SIZE	L	N	N1
362PTC-4	1/4	1.52	1.06	.50
362PTC-6	3/8	2.03	1.43	.68
362PTC-8	1/2	2.20	1.74	.84

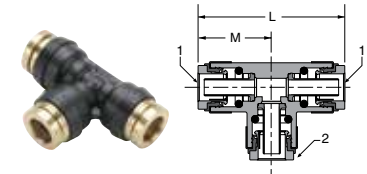

Union Tee 364PTC

PART NO.	TUBE SIZE 1	TUBE SIZE 2	L	M
364PTC-4	1/4	1/4	1.42	.71
364PTC-6	3/8	3/8	1.99	.99
364PTC-8	1/2	1/2	2.25	1.13
364PTC-10	5/8	5/8	2.88	1.44
364PTC-6-6-4	3/8	1/4	2.03	1.01
364PTC-6-6-5/32	3/8	5/32	2.03	1.01

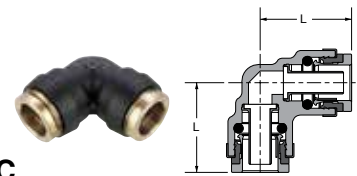

Union Elbow 365PTC

PART NO.	TUBE SIZE	L
365PTC-6	3/8	.99
365PTC-8	1/2	1.11

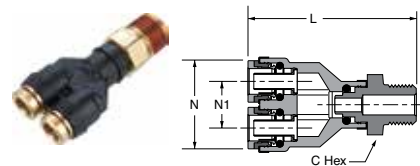

Union Y Male Connector VS368PTCR

PART NO.	TUBE SIZE	PIPE THREAD	L	C HEX	N	N1
VS368PTCR-4-2	1/4	1/8	1.96	9/16	1.03	.50
VS368PTCR-4-4	1/4	1/4	2.12	9/16	1.03	.50
VS368PTCR-6-4	3/8	1/4	2.56	3/4	1.41	.68

WARNING These products can expose you to chemicals including LEAD which is known to the state of California to cause cancer and birth defects or other reproductive harm. For more information go to www.P65Warnings.ca.gov.

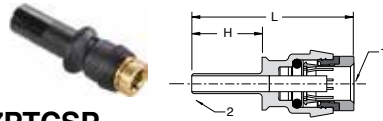

Plug-In Adapter 37PTCSP

PART NO.	TUBE SIZE 1	TUBE SIZE 2	H	L
37PTCSP-4-6	1/4	3/8	.90	1.71
37PTCSP-6-4	3/8	1/4	.76	1.66
37PTCSP-10-8	5/8	1/2	1.10	2.44

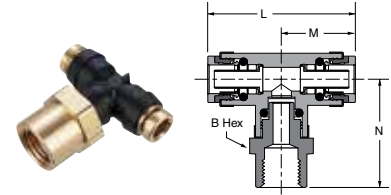

Female Branch Tee Swivel 377PTC

PART NO.	TUBE SIZE	PIPE THREAD	B HEX	L	M	N
377PTC-4-4	1/4	1/4	3/4	1.48	.74	1.27

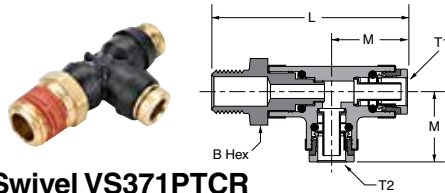

Male Run Tee Swivel VS371PTCR

PART NO.	TUBE SIZE 1	TUBE SIZE 2	PIPE THREAD	B HEX	L	M
VS371PTCR-4-2	1/4	1/4	1/8	9/16	1.80	.76
VS371PTCR-4-4	1/4	1/4	1/4	9/16	1.94	.76
VS371PTCR-6-4	3/8	3/8	1/4	3/4	2.29	.101
VS371PTCR-6-6	3/8	3/8	3/8	3/4	2.29	.101
VS371PTCR-8-4	1/2	1/2	1/4	15/16	2.59	1.15
VS371PTCR-8-6	1/2	1/2	3/8	15/16	2.59	1.15
VS371PTCR-8-8	1/2	1/2	1/2	15/16	2.78	1.15
VS371PTCR-10-8	5/8	5/8	1/2	1-1/16	3.24	1.44

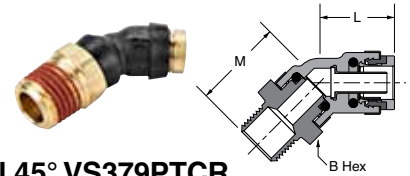

Male Elbow Swivel 45° VS379PTCR

PART NO.	TUBE SIZE	PIPE THREAD	B HEX	L	M
VS379PTCR-4-2	1/4	1/8	9/16	.68	.91
VS379PTCR-4-4	1/4	1/4	9/16	.68	1.05
VS379PTCR-6-2	3/8	1/8	3/4	.89	.99
VS379PTCR-6-4	3/8	1/4	3/4	.89	1.14
VS379PTCR-6-6	3/8	3/8	3/4	.89	1.15
VS379PTCR-6-8	3/8	1/2	15/16	.89	1.36
VS379PTCR-8-4	1/2	1/4	15/16	1.03	1.22
VS379PTCR-8-6	1/2	3/8	15/16	1.03	1.22
VS379PTCR-8-8	1/2	1/2	15/16	1.03	1.41
VS379PTCR-10-6	5/8	3/8	1-1/16	1.21	1.43
VS379PTCR-10-8	5/8	1/2	1-1/16	1.21	1.62
VS379PTCR-12-8	3/4	1/2	1-3/16	1.29	1.72

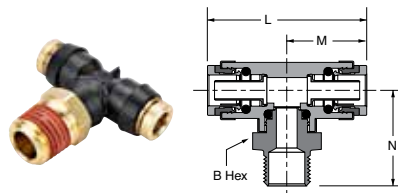

Male Branch Tee Swivel VS372PTCR

PART NO.	TUBE SIZE 1	TUBE SIZE 2	PIPE THREAD	B HEX	L	M	N
VS372PTCR-4-2	1/4	1/8	1/8	9/16	1.52	.76	1.04
VS372PTCR-4-4	1/4	1/4	1/4	9/16	1.52	.76	1.18
VS372PTCR-6-2	3/8	1/8	1/8	3/4	2.02	1.01	1.16
VS372PTCR-6-4	3/8	1/4	1/4	3/4	2.03	1.01	1.31
VS372PTCR-6-6	3/8	3/8	3/8	3/4	2.02	1.01	1.31
VS372PTCR-8-4	1/2	1/4	1/4	15/16	2.30	1.15	1.42
VS372PTCR-8-6	1/2	3/8	3/8	15/16	2.30	1.15	1.42
VS372PTCR-8-8	1/2	1/2	1/2	15/16	2.30	1.15	1.61
VS372PTCR-10-8	5/8	1/2	1/2	1-1/16	2.88	1.44	1.80

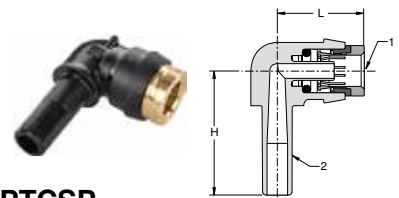

Plug-In Elbow 369PTCSP

PART NO.	TUBE SIZE 1	TUBE SIZE 2	H	L
369PTCSP-4-4	1/4	1/4	1.06	.74
369PTCSP-4-6	1/4	3/8	1.20	.74
369PTCSP-6-4	3/8	1/4	1.18	.96
369PTCSP-6-6	3/8	3/8	1.32	0.96
369PTCSP-6-8	3/8	1/2	1.52	.96
369PTCSP-8-4	1/2	1/4	1.16	1.12
369PTCSP-10-8	5/8	1/2	1.57	1.36

WARNING These products can expose you to chemicals including LEAD which is known to the state of California to cause cancer and birth defects or other reproductive harm. For more information go to www.P65Warnings.ca.gov.

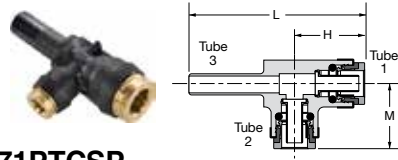

Plug-In Run Tee 371PTCSP

PART NO.	TUBE SIZE 1	TUBE SIZE 2	TUBE SIZE 3	H	L	M
371PTCSP-4-4	1/4	1/4	1/4	.78	1.84	.76
371PTCSP-4-6	1/4	1/4	3/8	.78	1.98	.76
371PTCSP-6-4	3/8	3/8	1/4	1.01	2.11	1.01
371PTCSP-6-6	3/8	3/8	3/8	1.01	2.25	1.01
371PTCSP-6-4-6	3/8	1/4	3/8	0.76	2.24	1.01
371PTCSP-8-4-8	1/2	1/4	1/2	0.96	2.58	1.15



Presto Manifold 24M

PART NO.	TUBE O.D. INLET	TUBE O.D. OUTLET	A	B	D	G	H	M	M1	N
24M-4-4	1/4	1/4	1.33	3.98	.21	2.75	.53	.90	.88	.89
24M-6-4	3/8	1/4	1.33	4.00	.21	2.75	.53	.90	.88	.89
24M-6-6	3/8	3/8	1.65	6.49	.22	4.55	.60	1.02	1.02	1.33
24M-8-8	1/2	1/2	1.65	6.49	.22	4.55	.60	1.02	1.02	1.33
24M-8-6446	1/2	3/8 - 1/4	1.65	6.49	.22	4.55	.64	1.02	1.02	1.17

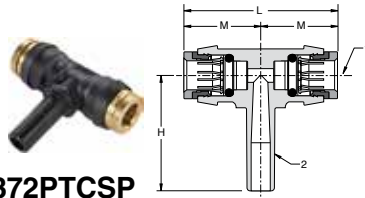

Plug-In Branch Tee 372PTCSP

PART NO.	TUBE SIZE 1	TUBE SIZE 2	H	L	M
372PTCSP-4-4	1/4	1/4	1.06	1.48	.74
372PTCSP-4-6	1/4	3/8	1.20	1.48	.74
372PTCSP-6-4	3/8	1/4	1.18	2.02	1.01
372PTCSP-6-6	3/8	3/8	1.32	2.02	1.01

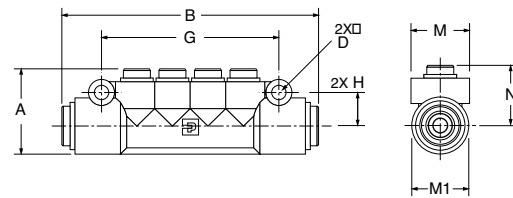

Assembly Instructions

1. Cut tubing squarely with Parker tube cutter PTC-001. Be certain that Manifold ports are clean and free of debris.
2. Insert tubing into port until it bottoms. Pull on tubing to verify that it is properly retained in the manifold.
3. To disassemble, simply hold release button against the manifold body and remove the tubing.
4. To reassemble, make certain that the Manifold ports are clean and free of debris and lubricate leading end of the tubing with light oil or petroleum jelly.

WARNING These products can expose you to chemicals including LEAD which is known to the state of California to cause cancer and birth defects or other reproductive harm. For more information go to www.P65Warnings.ca.gov.



Brass PTC

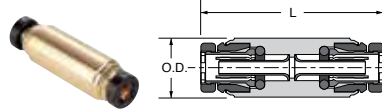

Union 62PTC

PART NO.	TUBE SIZE	L	O.D.
62PTC-5/32	5/32	1.37	.41
62PTC-3	3/16	1.36	.44

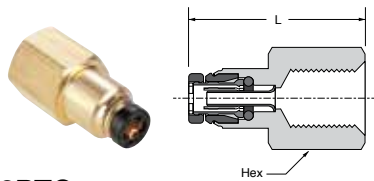

Male Connector 68PTC

PART NO.	TUBE SIZE	PIPE THREAD	HEX	L
68PTC-5/32-1	5/32	1/16	3/8	.85
68PTC-5/32-2	5/32	1/8	7/16	.92
68PTC-5/32-4	5/32	1/4	9/16	1.02
68PTC-3-1	3/16	1/16	7/16	.92
68PTC-3-2	3/16	1/8	7/16	.85
68PTC-3-4	3/16	1/4	9/16	1.02

Female Connector 66PTC

PART NO.	TUBE SIZE	PIPE THREAD	L	HEX
66PTC-5/32-2	5/32	1/8	1.17	9/16
66PTC-5/32-4	5/32	1/4	1.34	11/16
66PTC-3-2	3/16	1/8	1.17	9/16

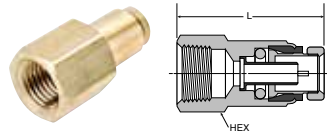

Male Connector VS68PTC

PART NO.	TUBE SIZE 1	PIPE THREAD	HEX	L
VS68PTC-4-2	1/4	1/8	1/2	.98
VS68PTC-4-4	1/4	1/4	9/16	1.02
VS68PTC-4-6	1/4	3/8	11/16	.93
VS68PTC-6-2	3/8	1/8	3/4	1.29
VS68PTC-6-4	3/8	1/4	3/4	1.44
VS68PTC-6-6	3/8	3/8	3/4	1.44
VS68PTC-6-8	3/8	1/2	7/8	1.63
VS68PTC-8-4	1/2	1/4	13/16	1.51
VS68PTC-8-6	1/2	3/8	13/16	1.46
VS68PTC-8-8	1/2	1/2	7/8	1.46
VS68PTC-10-6	5/8	3/8	1	1.74
VS68PTC-10-8	5/8	1/2	1	1.81
VS68PTC-12-8	3/4	1/2	1-1/8	1.89

Female Connector 66PTC

PART NO.	TUBE SIZE 1	PIPE THREAD	B HEX	L
66PTC-4-2	1/4	1/8	9/16	1.22
66PTC-4-4	1/4	1/4	11/16	1.37
66PTC-6-2	3/8	1/8	3/4	1.38
66PTC-6-4	3/8	1/4	3/4	1.59
66PTC-6-6	3/8	3/8	3/4	1.59
66PTC-8-4	1/2	1/4	7/8	1.61
66PTC-8-6	1/2	3/8	15/16	1.87
66PTC-8-8	1/2	1/2	15/16	1.87

WARNING These products can expose you to chemicals including LEAD which is known to the state of California to cause cancer and birth defects or other reproductive harm. For more information go to www.P65Warnings.ca.gov.

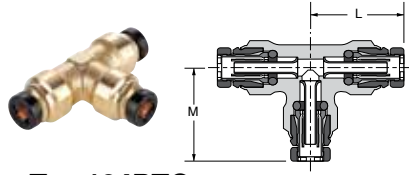

Tube to Tube Union Tee 164PTC

PART NO.	TUBE SIZE	L	M
164PTC-5/32	5/32	.77	.77
164PTC-3	3/16	.77	.77

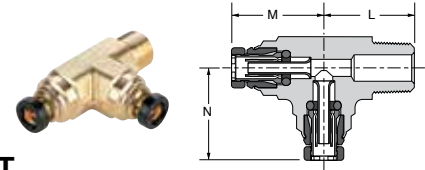

Tube to Male NPT Male Run Tee Rigid 171PTCNS

PART NO.	TUBE SIZE	PIPE THREAD	L	M	N
171PTCNS-5/32-2	5/32	1/8	.75	.78	.78
171PTCNS-5/32-4	5/32	1/4	.88	.78	.78
171PTCNS-3-2	3/16	1/8	.75	.77	.77

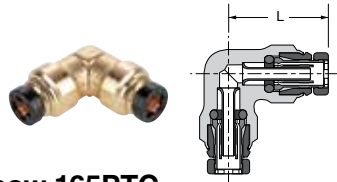

Tube to Tube Union Elbow 165PTC

PART NO.	TUBE SIZE	L
165PTC-5/32	5/32	.77
165PTC-3	3/16	.77

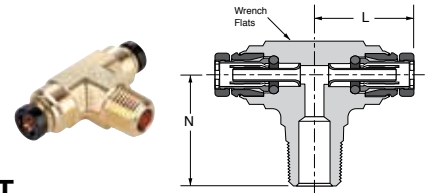

Tube to Male NPT Male Branch Tee Rigid 172PTCNS

PART NO.	TUBE SIZE	PIPE HREAD	L	N	WRENCH FLATS
172PTCNS-5/32-2	5/32	1/8	.78	.75	.47
172PTCNS-5/32-4	5/32	1/4	.78	.88	.47
172PTCNS-3-2	3/16	1/8	.77	.75	.47

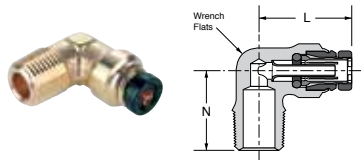

Tube to Male NPT Male Elbow Rigid 90° 169PTCNS

PART NO.	TUBE SIZE	PIPE THREAD	WRENCH FLATS	L	N
169PTCNS-5/32-1	5/32	1/16	.40	.77	.62
169PTCNS-5/32-2	5/32	1/8	.40	.77	.65
169PTCNS-5/32-4	5/32	1/4	.50	.77	.85
169PTCNS-3-2	3/16	1/8	.40	.77	.65
169PTCNS-3-4	3/16	1/4	.49	.77	.85

WARNING These products can expose you to chemicals including LEAD which is known to the state of California to cause cancer and birth defects or other reproductive harm. For more information go to www.P65Warnings.ca.gov.





Prestomatic Fittings

Parker's Prestomatic Fitting is a robust, all brass push-to-connect fitting that meets SAE and D.O.T. specifications. Designed for all D.O.T truck and trailer applications, Parker Prestomatic fittings reduce assembly time versus compression style fittings by 90%.

Product Features:

- Brass Collet
- Buna N O-ring
- Stainless Steel Tube Support
- Meets D.O.T. FMVSS571.106
- Meets SAE J2494 & SAE J2494-3

Markets:

- Heavy Duty Truck
- Trailer
- Mobile

Applications:

- Air Brakes
- Air Tanks
- Air Ride
- Sliders
- Tire Inflation
- Primary & Secondary Air Lines

Specifications:

Pressure Range Up to 250 PSI (17.2 bar)

Temperature Range -40° to +200° F (-40° to +93.3° C)

Compatible Tubing:

- SAE J844 Type A & B nylon tubing

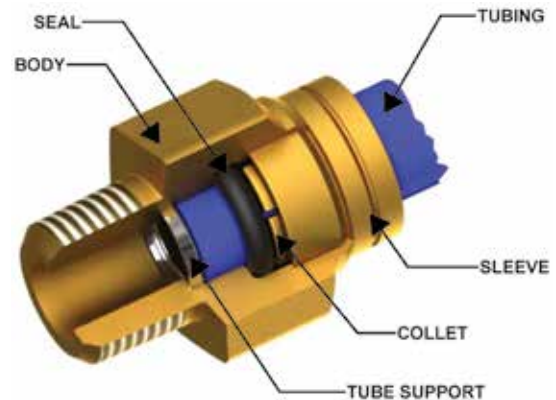

Assembly Instructions

1. Cut tubing squarely – maximum of 15° angle allowable.
2. Check that port or mating part is clean and free of debris.
3. Mark tubing to appropriate tube insertion length. (see Tube Insertion Chart on page N22)
4. Insert tubing until it bottoms
5. Pull on tubing to verify it is fully inserted
6. To disassemble, simply press release button, hold against body and pull tubing out of fitting.

WARNING These products can expose you to chemicals including NICKEL or LEAD, which are known to the state of California to cause cancer, and LEAD which is known to cause birth defects or other reproductive harm. For more information go to www.P65Warnings.ca.gov.



Prestomatic⁺ Retaining Ring Bulkhead Unions

Prestomatic⁺ retaining ring bulkhead unions feature a unique design that provides the user with an economical method to install and assemble a union connection through a bulkhead.

The retaining ring bulkhead unions feature a smaller envelope size than standard bulkhead union connectors and do not require a wrench to mount or assemble in cramped areas.

The external seal feature provides a moisture barrier and can also prevent external contamination from entering into an enclosed area.

To install, simply support the bulkhead union from behind and apply the external seal. Then push the external retainer against the external seal with an assembly tool and you have a reliable bulkhead connection in a confined area.

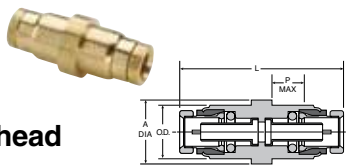
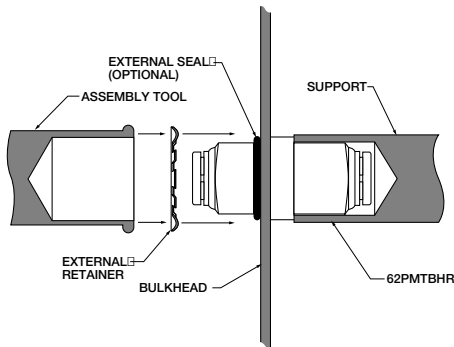

Retaining Ring Bulkhead 62PMTBHR

PART NO.	TUBE SIZE	O.D.	REC. HOLE SIZE	L	P MAX	A DIA
62PTCBHR-4*	1/4	.500	.512	1.53	.26	.625
62PMTBHR-6	3/8	.750	.762	1.92	.36	.875
62PMTBHR-8	1/2	.875	.887	2.15	.43	1.000
62PMTBHR-10	5/8	1.000	1.012	2.54	.62	1.250

*Sleeve color may vary

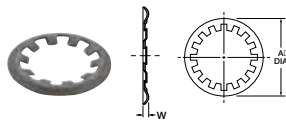

External Retainer ERHD*

PART NO.	TUBE SIZE	BULKHEAD UNION O.D.	A DIA.	W
ERHD-50	1/4	.500	.83	.05
ERHD-75	3/8	.750	1.08	.05
ERHD-87	1/2	.875	1.20	.05
ERHD-100	5/8	1.000	1.33	.06

*Material Carbon Spring Steel

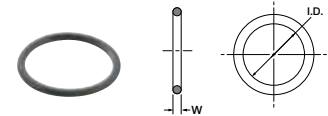

External Seal ES*

PART NO.	TUBE SIZE	BULKHEAD UNION O.D.	I.D.	W
ES-50	1/4	.500	.489	.07
ES-75	3/8	.750	.739	.07
ES-87	1/2	.875	.864	.07

*Material is Nitrile (Buna N), 70 Durometer

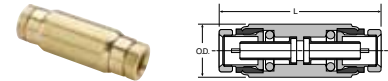

Union 62PMT

PART NO.	TUBE SIZE	L	O.D.
62PTC-4*	1/4	1.48	.50
62PMT-6	3/8	1.87	.75
62PTC-6-4*	3/8-1/4	1.68	.75
62PMT-8	1/2	2.03	.88
62PMT-10	5/8	2.42	1.00

*Sleeve color may vary

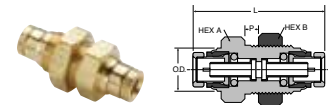

Bulkhead Union 62PMTBH

PART NO.	TUBE SIZE	O.D.	L	P MAX	HEX A	HEX B	BULKHEAD HOLE DIA.
62PTCBH-4*	1/4	.56	1.69	.25	11/16	3/4	9/16
62PMTBH-6	3/8	.88	1.93	.44	1-1/16	1-1/16	7/8
62PMTBH-8	1/2	1.00	2.02	.58	1-1/4	1-1/4	1
62PMTBH-10	5/8	1.12	2.92	.81	1-1/4	1-3/8	1-1/8

*Sleeve color may vary

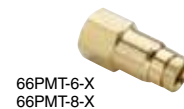

66PMT-6-X
66PMT-8-X

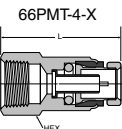

66PMT-4-X

Female Connector 66PMT

PART NO.	TUBE SIZE	PIPE THREAD	L	HEX
66PTC-4-2*	1/4	1/8	1.22	9/16
66PTC-4-4*	1/4	1/4	1.43	11/16
66PMT-6-2	3/8	1/8	1.37	3/4
66PMT-6-4	3/8	1/4	1.58	3/4
66PMT-6-6	3/8	3/8	1.62	13/16
66PMT-8-4	1/2	1/4	1.69	7/8
66PMT-8-6	1/2	3/8	1.68	7/8
66PMT-8-8	1/2	1/2	1.91	1

*Sleeve color may vary

WARNING These products can expose you to chemicals including NICKEL or LEAD, which are known to the state of California to cause cancer, and LEAD which is known to cause birth defects or other reproductive harm. For more information go to www.P65Warnings.ca.gov.

Bulkhead Female Connector 66PMTBH

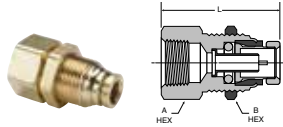

PART NO.	TUBE SIZE	PIPE THREAD	L	HEX A	HEX B	BULKHEAD HOLE DIA.
66PTCBH-4-4*	1/4	1/4	1.62	11/16	3/4	9/16
66PMTBH-6-6	3/8	3/8	1.87	1.06	1.06	7/8
66PMTBH-8-8	1/2	1/2	2.02	1-1/4	1-1/4	1

*Sleeve color may vary

Bulkhead Male Connector 68PMTBH

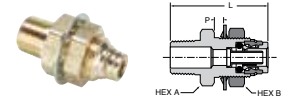

PART NO.	TUBE SIZE	PIPE THREAD	L	P MAX	HEX A	HEX B	BULKHEAD HOLE DIA.
68PMTBH-6-8	3/8	1/2	2.37	.33	1-1/4	1-1/4	1
68PMTBH-8-8	1/2	1/2	2.38	.33	1-1/4	1-1/4	1

Male Connector 68PMT

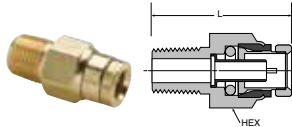

PART NO.	TUBE SIZE	PIPE THREAD	L	HEX
68PTC-4-2*	1/4	1/8	1.06	1/2
68PTC-4-4*	1/4	1/4	1.19	9/16
68PTC-4-6*	1/4	3/8	1.27	3/4
68PMT-6-2	3/8	1/8	1.37	3/4
68PMT-6-4	3/8	1/4	1.43	3/4
68PMT-6-6	3/8	3/8	1.33	3/4
68PMT-6-8	3/8	1/2	1.38	7/8
68PMT-8-4	1/2	1/4	1.72	7/8
68PMT-8-6	1/2	3/8	1.52	7/8
68PMT-8-8	1/2	1/2	1.44	7/8
68PMT-10-6	5/8	3/8	1.88	1
68PMT-10-8	5/8	1/2	1.88	1
68PMT-12-8	3/4	1/2	2.03	1 3/16
68PMT-12-12	3/4	3/4	2.03	1 1/8

*Sleeve color may vary

Union Tee 164PMT

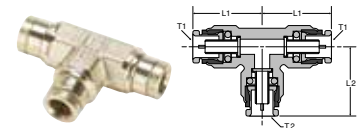

PART NO.	TUBE 1 SIZE	TUBE 2 SIZE	L1	L2
164PMT-4	1/4	1/4	.85	.85
164PMT-6	3/8	3/8	1.21	1.21
164PMT-6-6-4	3/8	1/4	1.21	.93
164PMT-8	1/2	1/2	1.27	1.27
164PMT-10	5/8	5/8	1.63	1.62

Union Elbow 165PMT

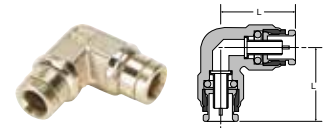

PART NO.	TUBE SIZE	L
165PMT-4	1/4	.85
165PMT-6	3/8	1.11
165PMT-8	1/2	1.24
165PMT-10	5/8	1.57

Male Connector to Metric Adapter 68PMT-X-M

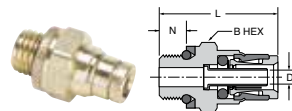

PART NO.	TUBE SIZE	METRIC THREAD	L	B HEX	N
68PTC-4-M12*	1/4	M12X1.5	1.19	11/16	.29
68PTC-4-M16*	1/4	M16X1.5	1.29	7/8	.39
68PMT-6-M12	3/8	M12X1.5	1.40	3/4	.29
68PMT-6-M16	3/8	M16X1.5	1.35	7/8	.39
68PMT-6-M22	3/8	M22X1.5	1.23	1 1/16	.40
68PMT-8-M12	1/2	M12X1.5	1.45	7/8	.29
68PMT-8-M16	1/2	M16X1.5	1.52	7/8	.39
68PMT-8-M22	1/2	M22X1.5	1.31	1 1/16	.37
68PMT-10-M16	5/8	M16X1.5	1.78	1	.39

*Sleeve color may vary

Union Bulkhead Elbow 165PMTBH

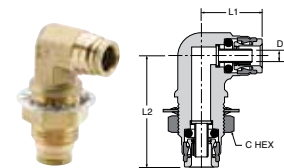

PART NO.	TUBE SIZE	L1	L2	C HEX	FLOW DIA. D	BULKHEAD HOLE DIA.
165PMTBH-8	1/2	1.29	2.45	1 1/4	.34	1

WARNING These products can expose you to chemicals including NICKEL or LEAD, which are known to the state of California to cause cancer, and LEAD which is known to cause birth defects or other reproductive harm. For more information go to www.P65Warnings.ca.gov.

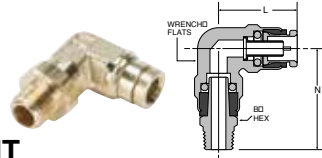

Male Elbow 90° 169PMT

PART NO.	TUBE SIZE	PIPE THREAD	L	N	WRENCH FLATS	B HEX
169PMT-4-2	1/4	1/8	.84	1.01	1/2	9/16
169PMT-4-4	1/4	1/4	.84	1.23	1/2	9/16
169PMT-4-6	1/4	3/8	.84	1.23	1/2	11/16
169PMT-6-2	3/8	1/8	1.11	1.18	9/16	11/16
169PMT-6-4	3/8	1/4	1.11	1.30	9/16	11/16
169PMT-6-6	3/8	3/8	1.11	1.33	9/16	11/16
169PMT-6-8	3/8	1/2	1.11	1.54	9/16	7/8
169PMT-8-4	1/2	1/4	1.27	1.73	11/16	5/8
169PMT-8-6	1/2	3/8	1.27	1.81	11/16	3/4
169PMT-8-8	1/2	1/2	1.27	1.96	11/16	7/8
169PMT-10-6	5/8	3/8	1.53	2.03	7/8	3/4
169PMT-10-8	5/8	1/2	1.53	2.18	7/8	7/8

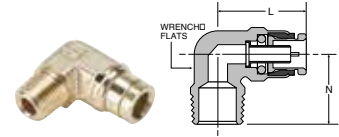

Male Elbow Rigid 90° 169PMTNS

PART NO.	TUBE SIZE	PIPE THREAD	L	N	WRENCH FLATS
169PMTNS-4-2	1/4	1/8	.84	.72	1/2
169PMTNS-4-4	1/4	1/4	.84	.90	1/2
169PMTNS-4-6	1/4	3/8	.84	1.06	1/2
169PMTNS-6-2	3/8	1/8	1.05	.75	9/16
169PMTNS-6-4	3/8	1/4	1.05	.94	9/16
169PMTNS-6-6	3/8	3/8	1.05	.94	3/4
169PMTNS-6-8	3/8	1/2	1.12	1.26	11/16
169PMTNS-8-4	1/2	1/4	1.17	1.06	11/16
169PMTNS-8-6	1/2	3/8	1.22	1.06	11/16
169PMTNS-8-8	1/2	1/2	1.22	1.26	11/16
169PMTNS-10-6	5/8	3/8	1.46	1.11	7/8
169PMTNS-10-8	5/8	1/2	1.46	1.32	7/8
169PTCNS-12-8	3/4	1/2	1.81	1.44	1

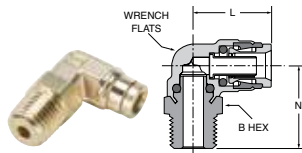

Male Elbow Positional 90° 169PMTR

PART NO.	TUBE SIZE	PIPE THREAD	B HEX	L	N	WRENCH FLATS
169PMTR-4-4	1/4	1/4	9/16	.84	1.13	1/2
169PMTR-6-6	3/8	3/8	3/4	1.12	1.19	9/16
169PMTR-10-8	5/8	1/2	7/8	1.54	1.50	7/8

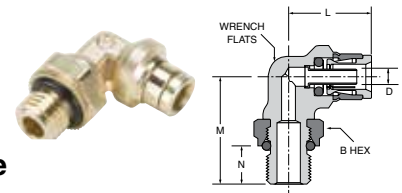

Male Elbow to Metric Adjustable 169PMTNS-X-M

PART NO.	TUBE SIZE	METRIC THREAD	WRENCH FLATS (MM)	HEX (MM)	L	M	N
169PMTNS-4-M12	1/4	M12X1.5	10	17	.84	1.11	.37
169PMTNS-4-M16	1/4	M16X1.5	11	24	.96	1.27	.41
169PMTNS-4-M22	1/4	M22X1.5	19	30	1.09	1.53	.41
169PMTNS-6-M12	3/8	M12X1.5	16	17	1.10	1.15	.66
169PMTNS-6-M16	3/8	M16X1.5	19	24	1.23	1.27	.41
169PMTNS-8-M12	1/2	M12X1.5	16	17	1.21	1.31	.37
169PMTNS-8-M16	1/2	M16X1.5	16	24	1.26	1.34	.41
169PMTNS-8-M22	1/2	M22X1.5	19	30	1.26	1.59	.41

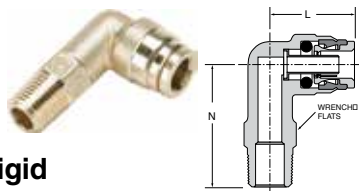

Male Elbow Long Rigid 90° 169PMTL

PART NO.	TUBE SIZE	PIPE THREAD	L	N	WRENCH FLATS
169PMTL-6-4	3/8	1/4	1.06	1.63	9/16
169PMTL-6-8	3/8	1/2	1.19	2.50	7/8
169PMTL-6-6	3/8	3/8	1.19	2.50	7/8
169PMTL-8-8	1/2	1/2	1.22	2.50	7/8

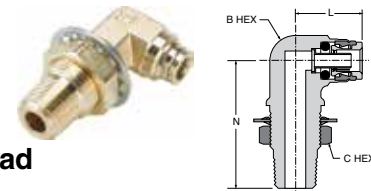

Male Elbow Bulkhead 169PMTBH

PART NO.	TUBE SIZE	PIPE THREAD	L	N	B HEX	C HEX	BULKHEAD HOLE DIA.
169PMTBH-6-8	3/8	1/2	1.19	2.50	1-1/4	7/8	1
169PMTBH-8-8	1/2	1/2	1.29	2.50	1-1/4	7/8	1

WARNING These products can expose you to chemicals including NICKEL or LEAD, which are known to the state of California to cause cancer, and LEAD which is known to cause birth defects or other reproductive harm. For more information go to www.P65Warnings.ca.gov.



Female Elbow Swivel 90° 170PMT

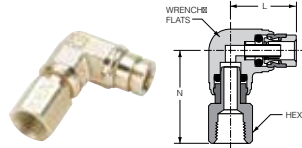

PART NO.	TUBE SIZE	PIPE THREAD	L	N	HEX	WRENCH FLATS
170PMT-4-2	1/4	1/8	.84	1.06	1/2	1/2

Female Elbow Rigid 90° 170PMTNS

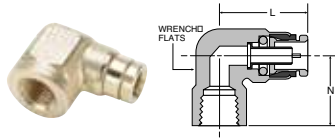

PART NO.	TUBE SIZE	PIPE THREAD	L	N	WRENCH FLATS
170PMTNS-4-2	1/4	1/8	.84	.56	11/16
170PMTNS-4-4	1/4	1/4	1.00	.67	11/16
170PMTNS-6-2	3/8	1/8	1.12	.64	9/16
170PMTNS-6-4	3/8	1/4	1.25	1.00	11/16
170PMTNS-6-6	3/8	3/8	1.25	1.00	13/16
170PMTNS-8-4	1/2	1/4	1.25	.75	11/16
170PMTNS-8-6	1/2	3/8	1.32	.88	11/16
170PMTNS-8-8	1/2	1/2	1.70	.98	1

Male Run Tee Swivel 171PMT

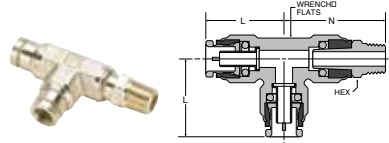

PART NO.	TUBE SIZE	PIPE THREAD	L	N	HEX	WRENCH FLATS
171PMT-4-2	1/4	1/8	.85	1.01	9/16	1/2
171PMT-4-4	1/4	1/4	.85	1.23	9/16	1/2
171PMT-4-6	1/4	3/8	.85	1.23	11/16	1/2
171PMT-6-4	3/8	1/4	1.21	1.42	11/16	5/8
171PMT-6-6	3/8	3/8	1.21	1.45	11/16	5/8
171PMT-8-4	1/2	1/4	1.27	1.74	5/8	7/8
171PMT-8-6	1/2	3/8	1.27	1.83	3/4	7/8
171PMT-8-8	1/2	1/2	1.27	1.99	7/8	7/8

Male Run Tee Rigid 171PMTNS

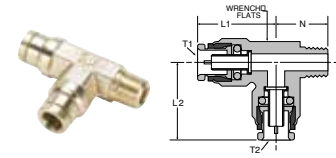

PART NO.	TUBE 1 SIZE	TUBE 2 SIZE	PIPE THREAD	L1	L2	N	WRENCH FLATS
171PMTNS-4-2	1/4	1/4	1/8	.91	.91	.77	15/32
171PMTNS-4-4	1/4	1/4	1/4	.91	.91	.94	15/32
171PMTNS-4-6-4	1/4	3/8	1/4	.93	1.21	.97	5/8
171PMTNS-6-4	3/8	3/8	1/4	1.21	1.21	.97	5/8
171PMTNS-6-4-4	3/8	1/4	1/4	1.21	.93	.97	5/8
171PMTNS-6-4-6	3/8	1/4	3/8	1.22	.97	.93	5/8
171PMTNS-6-6	3/8	3/8	3/8	1.21	1.21	.97	5/8
171PMTNS-6-8	3/8	3/8	1/2	1.17	1.17	1.26	5/8
171PMTNS-8-4	1/2	1/2	1/4	1.28	1.28	1.06	7/8

Male Branch Tee Swivel 172PMT

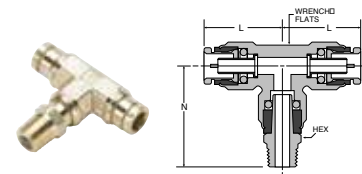

PART NO.	TUBE SIZE	PIPE THREAD	L	N	HEX	WRENCH FLATS
172PMT-4-2	1/4	1/8	.85	1.01	9/16	1/2
172PMT-4-4	1/4	1/4	.85	1.23	9/16	1/2
172PMT-6-2	3/8	1/8	1.22	1.30	11/16	5/8
172PMT-6-4	3/8	1/4	1.22	1.42	11/16	5/8
172PMT-6-6	3/8	3/8	1.22	1.45	11/16	5/8
172PMT-8-4	1/2	1/4	1.27	1.73	5/8	7/8
172PMT-8-6	1/2	3/8	1.27	1.79	3/4	7/8
172PMT-8-8	1/2	1/2	1.27	1.97	7/8	7/8

Male Branch Tee Rigid 172PMTNS

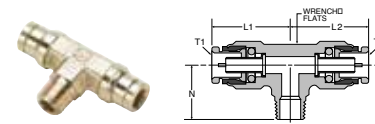

PART NO.	TUBE 1 SIZE	TUBE 2 SIZE	PIPE THREAD	L1	L2	N	WRENCH FLATS
172PMTNS-4-2	1/4	1/4	1/8	.91	.91	.78	1/2
172PMTNS-6-4	3/8	3/8	1/4	1.21	1.21	.97	5/8
172PMTNS-6-4-4	3/8	1/4	1/4	1.21	.93	.97	5/8
172PMTNS-6-6	3/8	3/8	3/8	1.21	1.21	.97	5/8
172PMTNS-6-8	3/8	3/8	1/2	1.17	1.17	1.26	7/8
172PMTNS-8-6	1/2	1/2	3/8	1.28	1.28	1.06	7/8
172PMTNS-8-6-8	1/2	3/8	1/2	1.25	1.25	1.25	7/8
172PMTNS-8-8	1/2	1/2	1/2	1.34	1.34	1.25	7/8

WARNING These products can expose you to chemicals including NICKEL or LEAD, which are known to the state of California to cause cancer, and LEAD which is known to cause birth defects or other reproductive harm. For more information go to www.P65Warnings.ca.gov.

Male Elbow Swivel 45° 179PMT

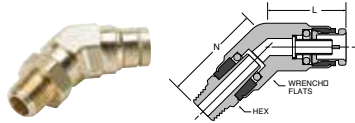

PART NO.	TUBE SIZE	PIPE THREAD	L	N	HEX	WRENCH FLATS
179PMT-4-2	1/4	1/8	.79	.92	9/16	9/16
179PMT-4-4	1/4	1/4	.79	1.14	9/16	9/16
179PMT-6-2	3/8	1/8	.99	1.02	11/16	3/4
179PMT-6-4	3/8	1/4	.99	1.14	11/16	3/4
179PMT-6-6	3/8	3/8	.99	1.17	11/16	3/4
179PMT-8-4	1/2	1/4	1.20	1.70	5/8	7/8
179PMT-8-6	1/2	3/8	1.20	1.78	3/4	7/8
179PMT-8-8	1/2	1/2	1.20	1.93	7/8	7/8

Dual port 90 Male Elbow Positional 189PMTR

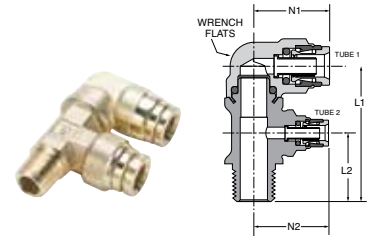

PART NO.	TUBE 1 SIZE	TUBE 2 SIZE	PIPE THREAD	L1	L2	N1	N2	WRENCH FLATS
189PMTR6-4-6	3/8	1/4	3/8	2.12	1.05	1.21	1.19	11/16
189PMTR6-6-4	3/8	3/8	1/4	2.06	.98	1.12	1.20	9/16
189PMTR6-6-6	3/8	3/8	3/8	2.06	.98	1.12	1.20	9/16
189PMTR10-4-6	5/8	1/4	3/8	2.18	1.05	1.54	1.19	7/8
189PMTR10-6-6	5/8	3/8	3/8	2.31	1.12	1.54	1.18	7/8

Male Elbow Positional Swivel 45° 179PMTR

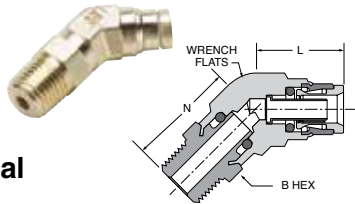

PART NO.	TUBE SIZE	PIPE THREAD	B HEX	L	N	WRENCH FLATS
179PMTR-4-4	1/4	1/4	9/16	.79	1.18	9/16
179PMTR-8-8	1/2	1/2	7/8	1.17	1.35	7/8

639PLP Plug

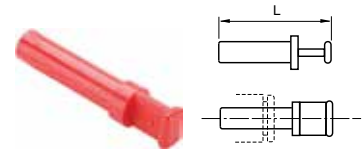

PART NO.	TUBE SIZE (IN)	L
639PLP-4	1/4	1.44
639PLP-6	3/8	1.67
639PLP-8	1/2	1.91

Male Elbow Rigid 45° 179PMTNS

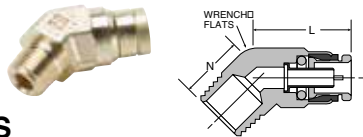

PART NO.	TUBE SIZE	PIPE THREAD	L	N	WRENCH FLATS
179PMTNS-4-2	1/4	1/8	.80	.56	9/16
179PMTNS-4-4	1/4	1/4	.80	.75	9/16
179PMTNS-6-2	3/8	1/8	.99	.55	3/4
179PMTNS-6-4	3/8	1/4	.99	.73	3/4
179PMTNS-6-6	3/8	3/8	.99	.73	3/4
179PMTNS-8-4	1/2	1/4	1.28	.81	13/16
179PMTNS-8-6	1/2	3/8	1.28	.81	13/16
179PMTNS-8-8	1/2	1/2	1.28	1.06	13/16
179PMTNS-10-6	5/8	3/8	1.22	.88	7/8
179PMTNS-10-8	5/8	1/2	1.22	1.00	7/8
179PTCNS-12-8	3/4	1/2	1.41	1.25	1

WARNING These products can expose you to chemicals including NICKEL or LEAD, which are known to the state of California to cause cancer, and LEAD which is known to cause birth defects or other reproductive harm. For more information go to www.P65Warnings.ca.gov.

Metric Prestomatic Fittings



Parker's Metric Prestomatic Fitting is a robust, all brass push-to-connect fitting that meets DIN and D.O.T. specifications. Designed for all D.O.T truck and trailer applications, Parker Metric Prestomatic fittings reduce assembly time versus compression style fittings by 90%.

Product Features:

- Brass Collet
- Buna N O-ring
- Stainless Steel Tube Support
- Meets D.O.T. FMVSS571.106
- Meets DIN 74324

Markets:

- Heavy Duty Truck
- Trailer
- Mobile

Applications:

- Air Brakes
- Air Tanks
- Air Ride
- Sliders
- Tire Inflation
- Primary & Secondary Air Lines

Specifications:

Pressure Range Up to 250 PSI (17.2 bar)

Temperature Range -40° to +200° F (-40° to +93.3° C)

Compatible Tubing:

- DIN 73378 Virgin Nylon
- SAE J844 Type A & B nylon tubing

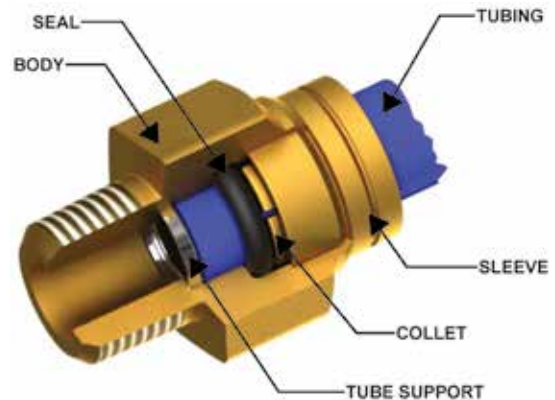

Assembly Instructions

1. Cut tubing squarely – maximum of 15° angle allowable.
2. Check that port or mating part is clean and free of debris.
3. Mark tubing to appropriate tube insertion length. (see Tube Insertion Chart on page N22)
4. Insert tubing until it bottoms
5. Pull on tubing to verify it is fully inserted
6. To disassemble, simply press release button, hold against body and pull tubing out of fitting.



WARNING These products can expose you to chemicals including NICKEL or LEAD, which are known to the state of California to cause cancer, and LEAD which is known to cause birth defects or other reproductive harm. For more information go to www.P65Warnings.ca.gov.



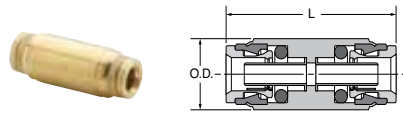

Union HPMTB

PART NO.	TUBE SIZE (MM)	L (MM)	O.D. (MM)
HPMTB6	6	45.2	15.9
HPMTB8	8	45.3	17.5
HPMTB10	10	51.7	22.2
HPMTB12	12	51.7	22.2

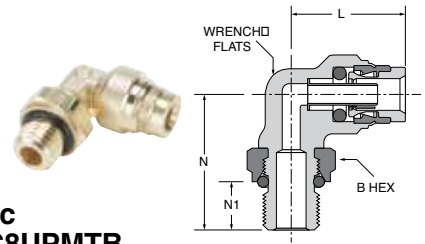

Male Elbow Metric Straight Thread C8UPMTB

PART NO.	TUBE SIZE (MM)	B METRIC THREAD	WRENCH FLATS (MM)	HEX (MM)	L (MM)	N (MM)	N1 (MM)
C8UPMTB6-M12	6	M12X1.5	10	17	24.8	28.2	9.5
C8UPMTB6-M16	6	M16X1.5	11	24	25.0	34.0	10.5

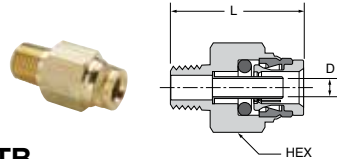

Male Connector F2PMTB

PART NO.	TUBE (MM)	PIPE THREAD	L (MM)	HEX (MM)	FLOW DIA. D (MM)
F2PMTB8-1/8	8	1/8	33.79	19	4.90
F2PMTB10-1/4	10	1/4	36.83	20	6.35

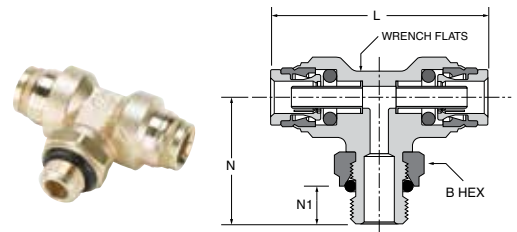

Male Branch Tee Swivel Metric Straight Thread S8UPMTB

PART NO.	TUBE SIZE (MM)	METRIC THREAD	WRENCH FLATS (MM)	HEX (MM)	L (MM)	N (MM)	N1 (MM)
S8UPMTB12-M16	12	M16X1.5	19	24	65.9	37.6	10.5

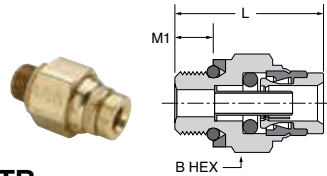

Male Connector Metric Straight Thread F8UPMTB

PART NO.	TUBE SIZE (mm)	METRIC THREAD	L (mm)	B HEX (MM)	M1 (MM)
F8UPMTB6-M10	6	M10X1	29.7	17	6.4
F8UPMTB6-M12	6	M12X1.5	29.1	17	7.5
F8UPMTB6-M22	6	M22X1.5	29.7	27	9.5
F8UPMTB8-M16	8	M16X1.5	31.0	22	10.0
F8UPMTB10-M16	10	M16X1.5	37.5	22	10.0
F8UPMTB10-M22	10	M22X1.5	31.1	27	9.5
F8UPMTB12-M12	12	M12X1.5	37.3	22	7.5
F8UPMTB12-M22	12	M22X1.5	33.4	27	9.5
F8UPMTB16-M22	16	M22X1.5	33.3	27	9.5

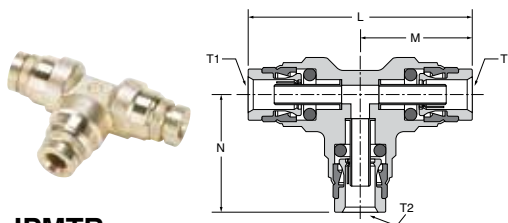

Union Tee JPMTB

PART NO.	TUBE 1 (MM)	TUBE 2 (MM)	L (MM)	M (MM)	N (MM)
JPMTB6	6	6	51.3	25.6	26.7
JPMTB12	12	12	63.3	31.7	35.0
JPMTB12-12-6	12	6	63.3	31.7	28.1

WARNING These products can expose you to chemicals including NICKEL or LEAD, which are known to the state of California to cause cancer, and LEAD which is known to cause birth defects or other reproductive harm. For more information go to www.P65Warnings.ca.gov.





PMH Fittings

Parker's PMH fittings are a push-to-connect hydraulic fitting designed to speed up assembly, especially in difficult to reach areas such as hydraulic joystick ports. Excellent corrosion resistance, a compact envelope, fewer potential leak points and light weight make PMH fittings an ideal solution.

Product Features:

- Brass Bodies & Collet
- Nitrile O-ring
- Weighs 60% less than standard hydraulic fittings
- Corrosion resistant
- Smaller envelope allowing for tighter routing

Markets:

- Industrial
- Mobile Hydraulic

Applications:

- Pilot Lines
- Hydraulic Joystick
- Case Drain

Specifications:

Pressure Range Up to 435 PSI (29.9 bar)

Temperature Range -40° to +200° F (-40° to +93.3° C)

Compatible Tubing:

- Parflex XDT

Assembly Instructions

1. Cut tubing squarely – maximum of 15° angle allowable.
2. Check that port or mating part is clean and free of debris.
3. Mark tubing to appropriate tube insertion length.
(see Tube Insertion Chart on page N22)
4. Insert tubing until it bottoms
5. Pull on tubing to verify it is fully inserted
6. To disassemble, simply press release button, hold against body and pull tubing out of fitting.



WARNING These products can expose you to chemicals including NICKEL or LEAD, which are known to the state of California to cause cancer, and LEAD which is known to cause birth defects or other reproductive harm. For more information go to www.P65Warnings.ca.gov.



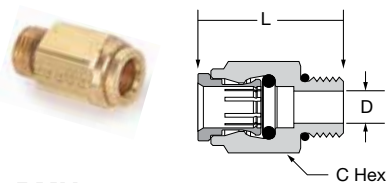

Male Connector 685PMH

PART NO.	TUBE SIZE	STRAIGHT THREAD	L	C HEX	FLOW DIA. D
685PMH-6-4	3/8	7/16-20	1.32	3/4	.18
685PMH-6-6	3/8	9/16-18	1.35	3/4	.30
685PMH-6-8	3/8	3/4-16	1.41	7/8	.30
685PMH-8-6	1/2	9/16-18	1.49	7/8	.30
685PMH-8-8	1/2	3/4-16	1.54	7/8	.40

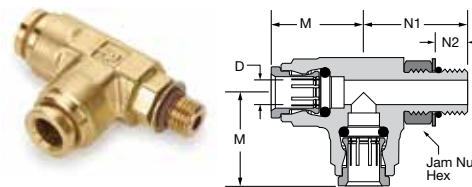

Male Run Tee 1715PMH

PART NO.	TUBE SIZE	STRAIGHT THREAD	M	N1	N2	BODY HEX	JAM NUT	FLOW DIA. D
1715PMH-6-4	3/8	7/16-20	1.12	1.18	.39	3/4	9/16	.18
1715PMH-6-6	3/8	9/16-18	1.12	1.25	.45	3/4	11/16	.30
1715PMH-6-8	3/8	3/4-16	1.12	1.4	.50	3/4	7/8	.30
1715PMH-8-6	1/2	9/16-18	1.12	1.3	.42	3/4	11/16	.30
1715PMH-8-8	1/2	3/4-16	1.12	1.4	.50	3/4	7/8	.40

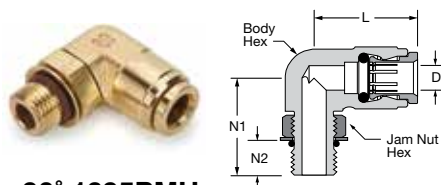

Male Connector 90° 1695PMH

PART NO.	TUBE SIZE	STRAIGHT THREAD	L	N1	N2	BODY HEX	JAM NUT	FLOW DIA. D
1695PMH-6-4	3/8	7/16-20	1.12	1.18	.39	3/4	9/16	.18
1695PMH-6-6	3/8	9/16-18	1.12	1.25	.45	3/4	11/16	.30
1695PMH-6-8	3/8	3/4-16	1.12	1.4	.50	3/4	7/8	.30
1695PMH-8-6	1/2	9/16-18	1.12	1.3	.42	3/4	11/16	.30
1695PMH-8-8	1/2	3/4-16	1.12	1.4	.50	3/4	7/8	.40

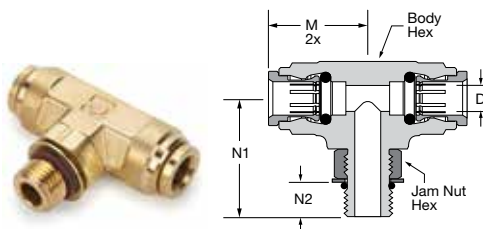

Male Branch Tee 1725PMH

PART NO.	TUBE SIZE	STRAIGHT THREAD	M	N1	N2	BODY HEX	JAM NUT	FLOW DIA. D
1725PMH-6-4	3/8	7/16-20	1.12	1.18	.39	3/4	9/16	.18
1725PMH-6-6	3/8	9/16-18	1.12	1.25	.45	3/4	3/4	.30
1725PMH-6-8	3/8	3/4-16	1.12	1.4	.50	3/4	7/8	.30
1725PMH-8-6	1/2	9/16-18	1.12	1.3	.42	3/4	11/16	.30
1725PMH-8-8	1/2	3/4-16	1.12	1.4	.50	3/4	7/8	.40

WARNING These products can expose you to chemicals including NICKEL or LEAD, which are known to the state of California to cause cancer, and LEAD which is known to cause birth defects or other reproductive harm. For more information go to www.P65Warnings.ca.gov.





Parker Safe Lock

Parker Safe Lock push-to-connect fittings reduce assembly time and the exclusive locking mechanism minimizes leaks and installation failures.

Parker Safe Lock Product Features:

- Composite Body – Strong, Lightweight, Compact and Impact Resistant
- Fluorocarbon and Fluorosilicone O-ring
- Meets SAE J2044

Markets:

- Heavy Duty Truck
- Trailer
- Mobile

Applications:

- Engine Fuel, Coolant and Vapor Lines

Parker Brass Adapter Product Features:

- **Construction:** Corrosion resistant high temperature brass
- **Configuration:** Rigid male pipe
- **Industry Standard:** SAE J2044

Specifications:

Pressure Range -7.2 to +72 PSI (-0.4 to 4.9 bar)

Temperature Range -40° to +239° F (-40° to +115° C)



WARNING These products can expose you to chemicals including NICKEL or LEAD, which are known to the state of California to cause cancer, and LEAD which is known to cause birth defects or other reproductive harm. For more information go to www.P65Warnings.ca.gov.



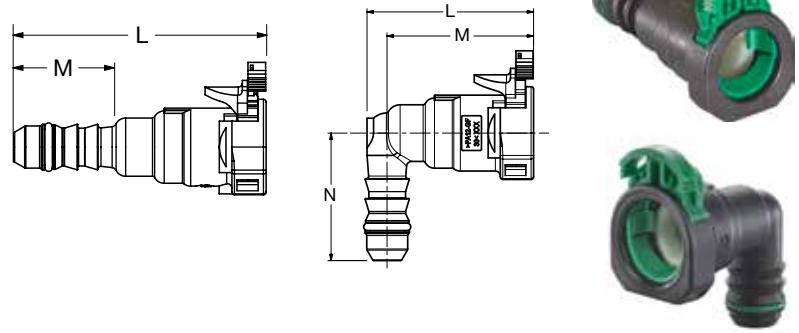

Parker Safe Lock A613, A614, A623, A624

END FORM	BARB TAIL	CONFIGURATION	PART NUMBER** AVAILABLE FROM FSC*	L (MM)	M (MM)	N (MM)
5/16"	5/16"	STRAIGHT	A614A50G06 02	49.40	19.50	N/A
		90 DEGREE	A624A50D06 02	29.50	19.50	25.70
10MM	3/8"	STRAIGHT	A613 52 08 00	55.00	19.00	N/A
		90 DEGREE	A623A52 08 00	34.40	19.00	32.00
3/8"	3/8"	STRAIGHT	A614M53 08 02	55.00	21.50	N/A
		90 DEGREE	A624M53 08 02	34.05	21.50	28.60
12MM	1/2"	STRAIGHT	A614A58 55 04	59.35	21.00	N/A
		90 DEGREE	A624A58 55 04	39.00	21.00	29.70
1/2"	1/2"	STRAIGHT	A614C56 55 05	59.15	21.00	N/A
		90 DEGREE	A624C56 55 05	39.00	21.00	29.70
5/8"	5/8"	STRAIGHT	A614D57 56 02 A	58.20	20.00	N/A
		90 DEGREE	624F57 56 02	39.10	20.00	30.10

*FSC is the Parker Fluid System Connectors Division. See back cover for contact information.

**Safe Lock Connector part numbers contain spaces.



Parker Safe Lock Brass Adapter 68ALS

PART NUMBER AVAILABLE FROM FSC*	END FORM	THREAD SIZE	PART NUMBER AVAILABLE FROM FSC*	END FORM	THREAD SIZE
68ALS-5-4	5/16"	1/4"	68ALS-12M-8	12MM	1/2"
68ALS-6-4	3/8"	1/4"	68ALS-8-6	1/2"	3/8"
68ALS-6-6	3/8"	3/8"	68ALS-8-8	1/2"	1/2"
68ALS-12M-6	12MM	3/8"	68ALS-10-8	5/8"	1/2"

Adapters are available with Metric Straight Thread O-Rings and Electroless Nickel Plating Upon Request

WARNING These products can expose you to chemicals including NICKEL or LEAD, which are known to the state of California to cause cancer, and LEAD which is known to cause birth defects or other reproductive harm. For more information go to www.P65Warnings.ca.gov.



Transportation Compression Fittings & Valves

Air Brake-NTA® Fittings

Transmission Fittings

Air Brake – AB Fittings









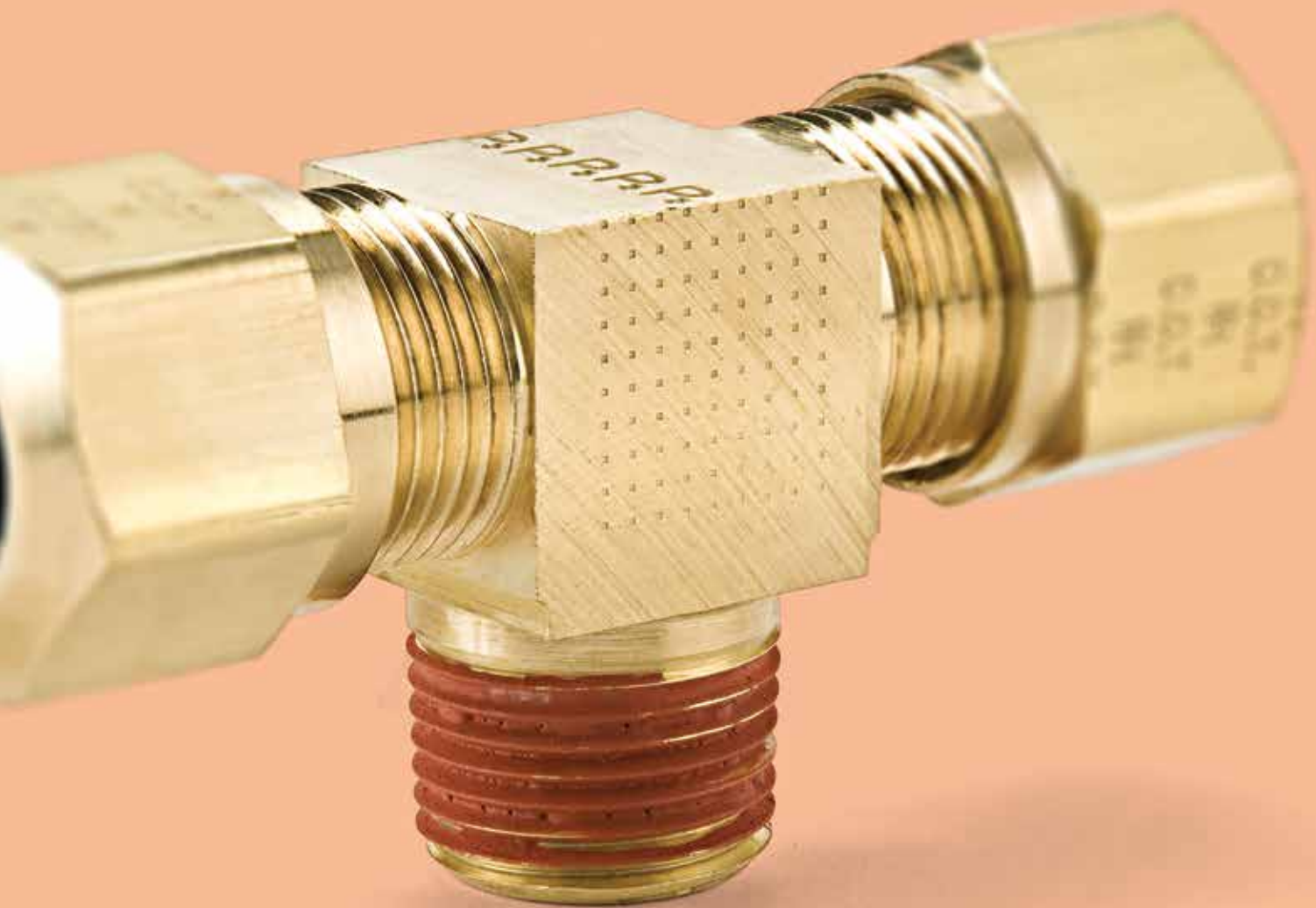

































Air Brake
Hose Ends Fittings

Vibra-Lok Fittings



























Truck Valves &
Lanyard Valve





Tube to Male NPTF	VS68NTA Male Connector  p. F8	VS176NTA Adapter  p. F8	VS269NTA Male Elbow  p. F9	VS271NTA Male Run Tee  p. F9	VS272NTA Male Branch Tee  p. F9	VS279NTA 45° Male Elbow  p. F9		
	68TF Male Connector  p. F11	269TF Male Elbow  p. F11	VS68AB Male Connector  p. F13	VS269AB Male Elbow  p. F14	VS271AB Male Run Tee  p. F14	VS272AB Male Branch Tee  p. F14	VS279AB 45° Male Elbow  p. F14	
	68RB Male Connector  p. F16	68RB Male Connector Body Only  p. F16	68RBSG Male Connector  p. F16	76RB Adapter  p. F16	68VL Male Connector  p. F18	169VL Male Elbow  p. F19	682VL Tank Fitting  p. F19	
	171VL Male Run Tee  p. F19	172VL Male Branch Tee  p. F19	179VL 45° Male Elbow  p. F19					
	Tube to Female NPTF	66NTA Female Connector  p. F8	270NTA Female Elbow  p. F9	66AB Female Connector  p. F13	270AB Female Elbow  p. F14	207ACBH Anchor Coupling  p. F14		
		66RBSV Female Connector  p. F16	66VL Female Connector  p. F18	170VL Female Elbow  p. F19	Tube to Straight Thread	685VLV Male Connector  p. F18	1695VL Male Elbow  p. F19	
		Tube to Metric Straight Thread	68NTA-X-MIX Male Connector  p. F8	Tube to Tube		62NTA Union  p. F7	264NTA Union Tee  p. F8	265NTA Union Elbow  p. F8
62AB Union  p. F13	264AB Union Tee  p. F13		265AB Union Elbow  p. F13		62RB Union  p. F16	62VL Union  p. F18	164VL Union Tee  p. F19	

WARNING These products can expose you to chemicals including NICKEL, CARBON BLACK, or LEAD, which are known to the state of California to cause cancer, and LEAD which is known to cause birth defects or other reproductive harm. For more information go to www.P65Warnings.ca.gov.

Bulkhead Union	62ANBH Bulkhead Union	62NBH Bulkhead Union	62NFBH Bulkhead Union	66NBH Bulkhead Union	62ABH Bulkhead Union	
	 p. F7	 p. F7	 p. F7	 p. F7	 p. F13	
Tube to Male Pipe	V408NTA Tube - Pipe	V410NTA Tube - Pipe	V412F Tube - Flare			
	 p. F21	 p. F21	 p. F21			
Hose to Male Pipe	V404P Hose - Pipe	V404PH Hose - Pipe	SV404P Hose - Pipe	Flare to Male Pipe	V409F Flare - Pipe	
	 p. F21	 p. F21	 p. F21		 p. F21	
Female Pipe to Male Pipe	V405P Female - Male	Lanyard Valve	LV91 Lanyard Valve	Auxiliary Component		
	 p. F21		 p. F21	60NTA Sleeve	61NTA Nut	
63NTA Tube Support	60TF Sleeve	61TF Nut	60AB Sleeve	61AB Nut	56RBSG Spring	60RB Sleeve
 p. F7	 p. F11	 p. F11	 p. F13	 p. F13	 p. F16	 p. F16
61RB Nut	61RBSG Spring Guard Nut	67RBSG Nut & Spring	60VL Sleeve	60VLV Sleeve	61VL Nut	
 p. F16	 p. F16	 p. F16	 p. F18	 p. F18	 p. F18	

WARNING These products can expose you to chemicals including NICKEL, CARBON BLACK, or LEAD, which are known to the state of California to cause cancer, and LEAD which is known to cause birth defects or other reproductive harm. For more information go to www.P65Warnings.ca.gov.



Air Brake-NTA® Fittings

Parker's NTA Fittings utilize a ribbed sleeve for compression and positive grip. Fittings meet SAE and D.O.T. specifications. Designed for all D.O.T truck and trailer applications. Electroless nickel plated bodies can be used with bio-diesel.

Product Features:

- Brass Body
- Meets D.O.T. FMVSS571.106 Performance
- Meets functional Requirements SAE J246 & SAE J1131
- Pre-applied Thread Sealant
- Nickel Plated Versions Available for Bio-diesel

Markets:

- Heavy Duty Truck
- Trailer
- Mobile

Applications:

- Air Brakes
- Air Tanks
- Air Ride
- Sliders
- Tire Inflation
- Primary & Secondary Air Lines
- Cab Controls

Specifications:

Pressure Range Up to 150 PSI (10.3 bar)

Temperature Range -40° to +200° F (-40° to +93.3° C)

Compatible Tubing:

- SAE J844 Type A & B nylon tubing

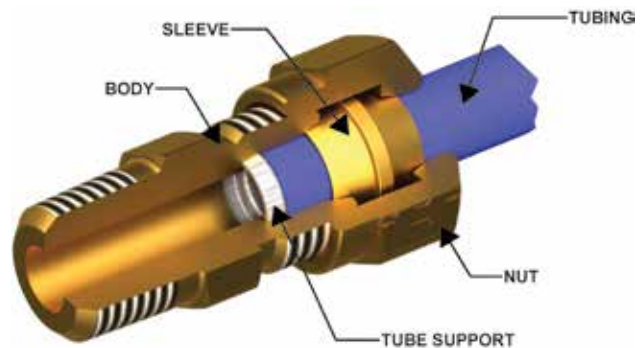

Assembly Instructions

1. Cut tubing squarely – maximum of 15° angle allowable.
2. Check that port or mating part is clean and free of debris.
3. Insert tubing until it bottoms on seat.
4. Tighten nut with wrench until one thread remains visible on the fitting body; (this will allow for a number of remakes) or, the nut should be screwed down finger tight, then wrench-tightened as indicated in the following table.

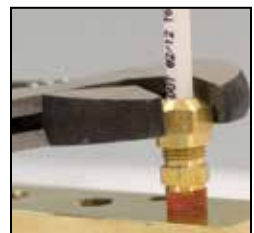

TUBE SIZE	ADDITIONAL NUMBER OF TURNS FROM HAND-TIGHT
3/16	2-1/2
1/4	3
3/8 & 1/2	4
5/8 & 3/4	3-1/2

WARNING These products can expose you to chemicals including NICKEL or LEAD, which are known to the state of California to cause cancer, and LEAD which is known to cause birth defects or other reproductive harm. For more information go to www.P65Warnings.ca.gov.

Sleeve 60NTA

REF. SAE 100115

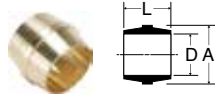

PART NO.	TUBE SIZE	A	D	L
60NTA-3*	3/16	.255	.194	.23
60NTA-4	1/4	.359	.256	.30
60NTA-6	3/8	.479	.384	.39
60NTA-8	1/2	.624	.509	.43
60NTA-10	5/8	.746	.634	.49
60NTA-12	3/4	.922	.760	.54

*Meets D.O.T. FMVSS 571.106 specification. No applicable SAE specification for this tube size.

Nut 61NTA

REF. SAE 100110

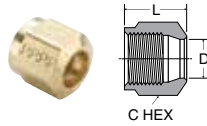

PART NO.	TUBE SIZE	STRAIGHT THREAD	C HEX	D	L
61NTA-3*	3/16	5/16-24	7/16	.194	.40
61NTA-4	1/4	7/16-24	9/16	.256	.45
61NTA-6	3/8	17/32-24	5/8	.384	.63
61NTA-8	1/2	11/16-20	13/16	.509	.72
61NTA-10	5/8	13/16-18	15/16	.634	.77
61NTA-12	3/4	1-18	1-1/8	.760	.81

*Meets D.O.T. FMVSS 571.106 specification. No applicable SAE specification for this tube size.

Union 62NTA

REF. SAE 100101 BA

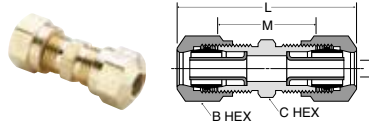

PART NO.	TUBE SIZE	STRAIGHT THREAD	B HEX	C HEX	L	M	FLOW DIA. D
62NTA-4	1/4	7/16-24	9/16	7/16	1.49	.83	.137
62NTA-6	3/8	17/32-24	5/8	9/16	2.00	1.08	.217
62NTA-8	1/2	11/16-20	13/16	11/16	2.32	1.29	.338
62NTA-10	5/8	13/16-18	15/16	13/16	2.39	1.41	.398
62NTA-12	3/4	1-18	1-1/8	1	2.60	1.58	.523

Stainless Steel Insert 63NTA

(FOR SAE J844 TUBING)

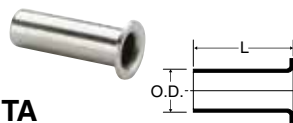

PART NO.	TUBE SIZE	L	O.D.
63NTA-4	1/4	.53	.163
63NTA-6	3/8	.64	.245
63NTA-8	1/2	.81	.370
63NTA-10	5/8	.86	.434
63NTA-12	3/4	1.04	.559

Bulkhead Union 62ANBH

(NTA® & AIR BRAKE)

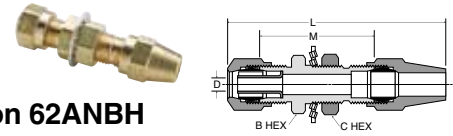

PART NO.	TUBE SIZE	STRAIGHT THREAD	B HEX	C HEX	L	M	FLOW DIA. D	BULKHEAD HOLE DIA.
62ANBH-4	1/4	7/16-24	9/16	9/16	2.28	1.38	.137	7/16
62ANBH-6	3/8	17/32-24	11/16	3/4	2.97	1.62	.217	17/32
62ANBH-8	1/2	11/16-20	13/16	1	3.36	1.88	.338	11/16

Bulkhead Union 62NBH

PART NO.	TUBE SIZE	STRAIGHT THREAD	B HEX	C HEX	L	M	FLOW DIA. D	BULKHEAD HOLE DIA.
62NBH-3*	3/16	5/16-24	7/16	7/16	1.80	1.21	.087	5/16
62NBH-4	1/4	7/16-24	9/16	9/16	2.04	1.38	.137	7/16
62NBH-6	3/8	17/32-24	11/16	3/4	2.54	1.62	.217	17/32
62NBH-8	1/2	11/16-20	13/16	1	2.92	1.88	.338	11/16
62NBH-10	5/8	13/16-18	15/16	1	2.99	2.01	.398	13/16

*Meets D.O.T. FMVSS 571.106 specification. No applicable SAE specification for this tube size.

Bulkhead Union 62NFBH

PART NO.	TUBE SIZE	FLARE SIZE	STGHT THD	B HEX	C HEX	L	M	FLOW DIA. D	BKHD HOLE DIA.
62NFBH-4	1/4	1/4	7/16-24	9/16	9/16	1.86	1.53	.137	7/16
62NFBH-6	3/8	3/8	17/32-24	3/4	3/4	2.24	1.78	.217	5/8
62NFBH-8	1/2	1/2	11/16-20	7/8	7/8	2.73	2.22	.338	3/4
62NFBH-10	5/8	5/8	13/16-18	1	1	2.68	2.21	.398	7/8
62NFBH-10-8	5/8	1/2	13/16-18	7/8	7/8	2.90	2.40	.398	3/4

Bulkhead Union 66NBH

PART NO.	TB SZ	PIPE THD	A STGHT THD	E STGHT THD	B HEX	C HEX	L	M	FLOW DIA. D	BKHD HOLE DIA.
66NBH-8-6	1/2	3/8	11/16-20	7/8-14	1-1/16	1-1/16	1.94	1.42	.338	7/8

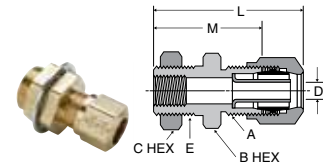

WARNING These products can expose you to chemicals including NICKEL or LEAD, which are known to the state of California to cause cancer, and LEAD which is known to cause birth defects or other reproductive harm. For more information go to www.P65Warnings.ca.gov.

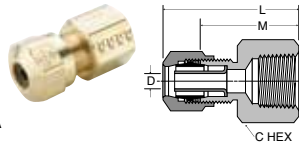

Female Connector 66NTA

REF. SAE 100103 BA

PART NO.	TUBE SIZE	PIPE THREAD	STRAIGHT THREAD	C HEX	L	M	FLOW DIA. D
66NTA-4-2	1/4	1/8	7/16-24	9/16	1.17	.84	.137
66NTA-4-4	1/4	1/4	7/16-24	11/16	1.40	1.07	.137
66NTA-6-2	3/8	1/8	17/32-24	9/16	1.46	1.00	.217
66NTA-6-4	3/8	1/4	17/32-24	11/16	1.64	1.18	.217
66NTA-6-6	3/8	3/8	17/32-24	7/8	1.64	1.18	.217
66NTA-8-6	1/2	3/8	11/16-20	7/8	1.79	1.27	.338
66NTA-8-8	1/2	1/2	11/16-20	1-1/16	1.96	1.44	.338
66NTA-10-6	5/8	3/8	13/16-18	7/8	1.80	1.31	.398
66NTA-10-8	5/8	1/2	13/16-18	1-1/16	1.99	1.50	.398

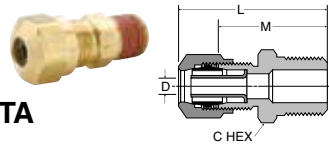

Male Connector VS68NTA

Ref. SAE 100102 BA

PART NO.	TUBE SIZE	PIPE THREAD	STRAIGHT THREAD	C HEX	L	M	FLOW DIA. D
VS68NTA-3-1*	3/16	1/16	5/16-24	3/8	1.16	.87	.087
VS68NTA-3-2*	3/16	1/8	5/16-24	7/16	1.15	.86	.087
VS68NTA-3-4*	3/16	1/4	5/16-24	9/16	1.35	1.05	.087
VS68NTA-4-2	1/4	1/8	7/16-24	7/16	1.22	.89	.137
VS68NTA-4-4	1/4	1/4	7/16-24	9/16	1.43	1.10	.137
VS68NTA-4-6	1/4	3/8	7/16-24	11/16	1.47	1.14	.137
VS68NTA-6-2	3/8	1/8	17/32-24	9/16	1.49	1.03	.217
VS68NTA-6-4	3/8	1/4	17/32-24	9/16	1.67	1.21	.217
VS68NTA-6-6	3/8	3/8	17/32-24	11/16	1.70	1.24	.217
VS68NTA-6-8	3/8	1/2	17/32-24	7/8	1.89	1.43	.217
VS68NTA-8-4	1/2	1/4	11/16-20	11/16	1.85	1.33	.338
VS68NTA-8-6	1/2	3/8	11/16-20	11/16	1.85	1.33	.338
VS68NTA-8-8	1/2	1/2	11/16-20	7/8	2.04	1.52	.338
VS68NTA-10-6	5/8	3/8	13/16-18	13/16	1.88	1.39	.398
VS68NTA-10-8	5/8	1/2	13/16-18	7/8	2.10	1.58	.398
VS68NTA-12-6	3/4	3/8	1-18	1	2.00	1.49	.440
VS68NTA-12-8	3/4	1/2	1-18	1	2.19	1.68	.523
VS68NTA-12-12	3/4	3/4	1-18	1-1/8	2.22	1.71	.523

*Meets D.O.T. FMVSS 571.106 specification. No applicable SAE specification for this tube size.

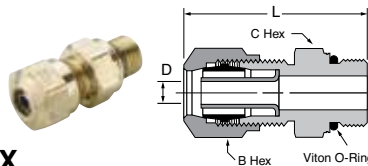

NTA® to Metric Adaptor 68NTA-X-MIX

PART NO.	TUBE SIZE	METRIC THREAD	B HEX	C HEX	L	D
68NTA-4-MI10	1/4	M10 X 1.0	9/16	9/16	1.33	.140

Note: Fluorocarbon o-ring is standard

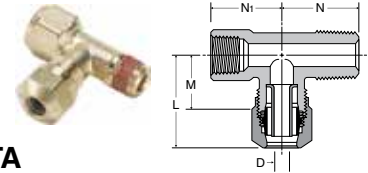

Adapter Tee VS176NTA

PART NO.	TUBE SIZE	PIPE THREAD	STRAIGHT THREAD	L	M	N	N1	FLOW DIA. D
VS176NTA-4-2	1/4	1/8	7/16-24	1.02	.69	.75	.66	.137

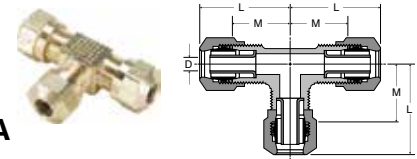

Union Tee 264NTA

REF. SAE 100401 BA

PART NO.	TUBE SIZE	STRAIGHT THREAD	L	M	FLOW DIA. D
264NTA-4	1/4	7/16-24	.95	.62	.137
264NTA-6	3/8	17/32-24	1.24	.78	.217
264NTA-8	1/2	11/16-20	1.45	.93	.338
264NTA-10	5/8	13/16-18	1.58	1.09	.398

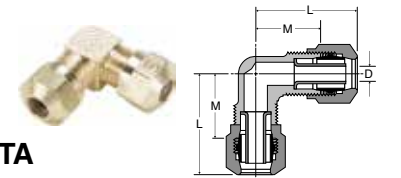

Union Elbow 265NTA

REF. SAE 100201 BA

PART NO.	TUBE SIZE	STRAIGHT THREAD	L	M	FLOW DIA. D
265NTA-4	1/4	7/16-24	.95	.62	.137
265NTA-6	3/8	17/32-24	1.25	.79	.217
265NTA-8	1/2	11/16-20	1.45	.93	.338
265NTA-10	5/8	13/16-18	1.58	1.09	.398

WARNING These products can expose you to chemicals including NICKEL or LEAD, which are known to the state of California to cause cancer, and LEAD which is known to cause birth defects or other reproductive harm. For more information go to www.P65Warnings.ca.gov.

Male Elbow VS269NTA

REF. SAE 100202 BA

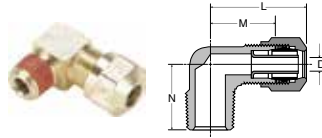

PART NO.	TUBE SIZE	PIPE THREAD	STRAIGHT THREAD	L	M	N	FLOW DIA. D
VS269NTA-3-2*	3/16	1/8	5/16-24	.90	.60	.67	.087
VS269NTA-3-4*	3/16	1/4	5/16-24	.91	.62	.87	.087
VS269NTA-4-2	1/4	1/8	7/16-24	.95	.62	.66	.137
VS269NTA-4-4	1/4	1/4	7/16-24	1.00	.68	.87	.137
VS269NTA-4-6	1/4	3/8	7/16-24	1.16	.73	.86	.137
VS269NTA-6-2	3/8	1/8	17/32-24	1.19	.73	.75	.217
VS269NTA-6-4	3/8	1/4	17/32-24	1.25	.79	.92	.217
VS269NTA-6-6	3/8	3/8	17/32-24	1.30	.84	.91	.217
VS269NTA-6-8	3/8	1/2	17/32-24	1.40	.94	1.10	.217
VS269NTA-8-4	1/2	1/4	11/16-20	1.38	.86	.99	.338
VS269NTA-8-6	1/2	3/8	11/16-20	1.44	.92	.99	.338
VS269NTA-8-8	1/2	1/2	11/16-20	1.55	1.03	1.18	.338
VS269NTA-10-6	5/8	3/8	13/16-18	1.49	1.00	1.05	.398
VS269NTA-10-8	5/8	1/2	13/16-18	1.58	1.09	1.24	.398
VS269NTA-10-12	5/8	3/4	13/16-18	1.76	1.25	1.32	.400
VS269NTA-12-8	3/4	1/2	1-18	1.70	1.19	1.33	.523
VS269NTA-12-12	3/4	3/4	1-18	1.77	1.26	1.32	.523

*Meets D.O.T. FMVSS 571.106 specification. No applicable SAE specification for this tube size.

Female Elbow 270NTA

REF. SAE 100203 BA

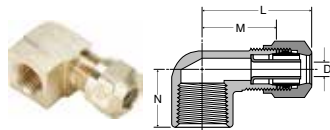

PART NO.	TUBE SIZE	PIPE THREAD	STRAIGHT THREAD	L	M	N	FLOW DIA. D
270NTA-3-2*	3/16	1/8	5/16-24	.96	.67	.52	.087
270NTA-4-2	1/4	1/8	7/16-24	1.02	.69	.52	.137
270NTA-4-4	1/4	1/4	7/16-24	1.11	.78	.71	.137
270NTA-6-2	3/8	1/8	17/32-24	1.29	.83	.59	.217
270NTA-6-4	3/8	1/4	17/32-24	1.35	.89	.77	.217
270NTA-6-6	3/8	3/8	17/32-24	1.39	.93	.77	.217
270NTA-8-6	1/2	3/8	11/16-20	1.55	1.03	.82	.338
270NTA-8-8	1/2	1/2	11/16-20	1.65	1.13	1.01	.338
270NTA-10-8	5/8	1/2	13/16-18	1.70	1.19	1.07	.398

*Meets D.O.T. FMVSS 571.106 specification. No applicable SAE specification for this tube size.

Male Run Tee VS271NTA

REF. SAE 100424 BA

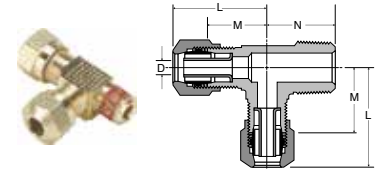

PART NO.	TUBE SIZE	PIPE THREAD	STRAIGHT THREAD	L	M	N	FLOW DIA. D
VS271NTA-4-2	1/4	1/8	7/16-24	.95	.62	.66	.137
VS271NTA-4-4	1/4	1/4	7/16-24	1.00	.68	.87	.137
VS271NTA-6-4	3/8	1/4	17/32-24	1.25	.79	.92	.217
VS271NTA-6-6	3/8	3/8	17/32-24	1.30	.84	.91	.217
VS271NTA-8-6	1/2	3/8	11/16-20	1.45	.93	.99	.338
VS271NTA-8-8	1/2	1/2	11/16-20	1.55	1.03	1.18	.338
VS271NTA-10-8	5/8	1/2	13/16-18	1.60	1.09	1.24	.398

Male Branch Tee VS272NTA

REF. SAE 100425 BA

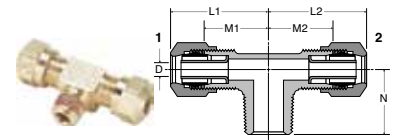

PART NO.	TB 1	TB 2	PIPE THD	STGHT THD	L1	L2	M1	M2	N	FLOW DIA. D
VS272NTA-3-2*	3/16	3/16	1/8	7/16-24	.90	.90	.61	.61	.66	.087
VS272NTA-4-2	1/4	1/4	1/8	7/16-24	.95	.95	.62	.62	.66	.137
VS272NTA-4-4	1/4	1/4	1/4	7/16-24	1.00	1.00	.68	.68	.87	.137
VS272NTA-6-2	3/8	3/8	1/8	17/32-24	1.18	1.18	.72	.72	.75	.217
VS272NTA-6-4	3/8	3/8	1/4	17/32-24	1.25	1.25	.91	.91	.92	.217
VS272NTA-6-4-4	3/8	1/4	1/4	7/16-24	.99	1.25	.67	.79	.91	.137
				17/32-24						
VS272NTA-6-6	3/8	3/8	3/8	17/32-24	1.30	1.30	.84	.84	.91	.217
VS272NTA-8-4	1/2	1/2	1/4	11/16-20	1.41	1.41	.89	.89	.99	.338
VS272NTA-8-6	1/2	1/2	3/8	11/16-20	1.45	1.45	.93	.93	.99	.338
VS272NTA-8-8	1/2	1/2	1/2	11/16-20	1.55	1.55	1.03	1.03	1.18	.338
VS272NTA-10-8	5/8	5/8	1/2	13/16-18	1.60	1.60	1.09	1.09	1.24	.398

*Meets D.O.T. FMVSS 571.106 specification. No applicable SAE specification for this tube size.

45° Elbow VS279NTA

REF. SAE 100302 BA

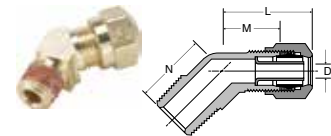

PART NO.	TUBE SIZE	PIPE THREAD	STRAIGHT THREAD	L	M	N	FLOW DIA. D
VS279NTA-4-2	1/4	1/8	7/16-24	.81	.49	.63	.137
VS279NTA-4-4	1/4	1/4	7/16-24	.93	.60	.85	.137
VS279NTA-6-2	3/8	1/8	17/32-24	1.17	.71	.68	.217
VS279NTA-6-4	3/8	1/4	17/32-24	1.17	.71	.85	.217
VS279NTA-6-6	3/8	3/8	17/32-24	1.21	.75	.94	.217
VS279NTA-6-8	3/8	1/2	17/32-24	1.24	.78	1.16	.217
VS279NTA-8-4	1/2	1/4	11/16-20	1.36	.84	.94	.338
VS279NTA-8-6	1/2	3/8	11/16-20	1.36	.84	.94	.338
VS279NTA-8-8	1/2	1/2	11/16-20	1.39	.87	1.16	.338
VS279NTA-10-6	5/8	3/8	13/16-18	1.43	.94	.98	.398
VS279NTA-10-8	5/8	1/2	13/16-18	1.42	.93	1.16	.398
VS279NTA-12-8	3/4	1/2	1-18	1.61	1.10	1.18	.523

WARNING These products can expose you to chemicals including NICKEL or LEAD, which are known to the state of California to cause cancer, and LEAD which is known to cause birth defects or other reproductive harm. For more information go to www.P65Warnings.ca.gov.

Transmission Fittings



Parker's Transmission Fittings utilizes a specially designed slotted sleeve to help eliminate notch stress related to over-torque. Ideal for pressure protected pneumatic transmission applications. Electroless nickel plated bodies can be used with bio-diesel.

Product Features:

- Brass Body
- D.O.T. Approved with Staked in Tube Support
- 3/16" & 5/32" Tube sizes
- Slotted Sleeve
- Nickel Plated Versions Available for Bio-diesel

Markets:

- Heavy Duty Truck

Applications:

- Air Shift Transmissions
- Seat Controls
- Dash Controls

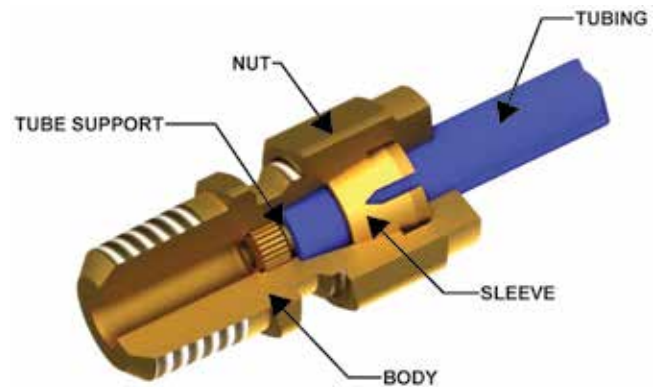

Specifications:

Pressure Range Up to 150 PSI (10.3 bar)

Temperature Range -40° to +200° F (-40° to +93.3° C)

Compatible Tubing:

- SAE J844 Type A & B nylon tubing

Assembly Instructions

1. Cut tubing squarely and remove burrs
2. Insert tubing into fitting until bottomed
3. Tighten nut 1 1/2 turns from finger tight



WARNING These products can expose you to chemicals including LEAD which is known to the state of California to cause cancer and birth defects or other reproductive harm. For more information go to www.P65Warnings.ca.gov.



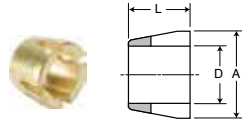

Sleeve 60TF

PART NO.	TUBE SIZE	A	D	L
60TF-2	1/8	.235	.130	0.17
60TF-5/32	5/32	.251	.165	0.18

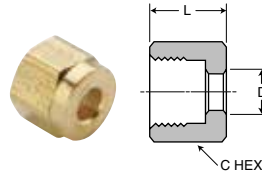

Nut 61TF

PART NO.	TUBE SIZE	D	L	STRT THD	C HEX
61TF-2	1/8	.133	.32	5/16-24	3/8
61TF-5/32	5/32	.163	.32	5/16-24	3/8

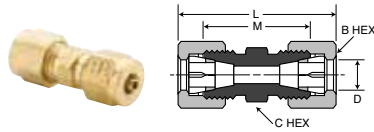

Union 62TF

PART NO.	TUBE SIZE	D	L	STRT THD	M	C HEX	B HEX
62TF-2	1/8	.109	1.04	5/16-24	.68	5/16	3/8
62TF-5/32	5/32	.068	1.04	5/16-24	.68	5/16	3/8

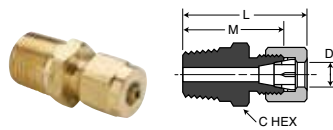

Male Connector 68TF

PART NO.	TUBE SIZE	PIPE THREAD	D	L	STRT THD	M	C HEX
68TF-2-1	1/8	1/16	.109	.96	5/16-24	.78	11/32
68TF-2-2	1/8	1/8	.109	.96	5/16-24	.78	7/16
68TF-5/32-1	5/32	1/16	.068	.84	5/16-24	.66	11/32
68TF-5/32-2	5/32	1/8	.068	.96	5/16-24	.78	7/16

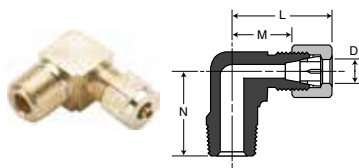

Male Elbow 269TF

PART NO.	TUBE SIZE	PIPE THREAD	D	L	STRT THD	M	N
269TF-2-2	1/8	1/8	.109	.79	5/16-24	.61	.66
269TF-5/32-2	5/32	1/8	.068	.79	5/16-24	.61	.66

WARNING These products can expose you to chemicals including LEAD which is known to the state of California to cause cancer and birth defects or other reproductive harm. For more information go to www.P65Warnings.ca.gov.





Air Brake – AB Fittings

Parker’s Air Brake - AB Fittings are economical compression style fittings for copper air brake lines. AB fittings meet the functional requirements of SAE and the performance requirements of D.O.T.

Product Features:

- Brass Body
- Meets D.O.T. FMVSS571.106 Performance
- Meets functional Requirements SAE J246
- Reusable
- Pre-applied Thread Sealant

Markets:

- Heavy Duty Truck
- Trailer
- Mobile

Applications:

- Copper Air Brake Lines
- Coolant Lines
- Fuel Lines

Specifications:

Pressure Range Up to 400 PSI (27.5 bar)

Temperature Range -65° to +250° F (-53.8° to +121.1° C)

Compatible Tubing:

- Copper Air Brake Tubing

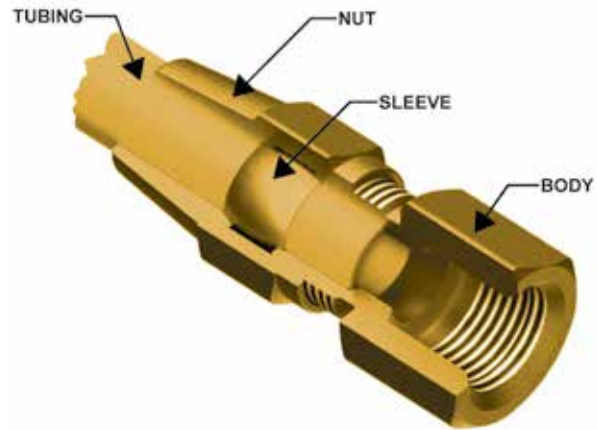

Assembly Instructions

1. Cut tubing squarely and remove burrs
2. Slide nut and sleeve onto tubing.
3. Insert tubing into fitting until bottomed on seat. The nut should be screwed down finger tight, then wrench tightened as indicated in the chart



TUBE SIZE	TURNS REQUIRED TO SEAL FROM HAND-TIGHT
1/4, 3/8, 1/2	2
5/8, 3/4	3

WARNING These products can expose you to chemicals including LEAD which is known to the state of California to cause cancer and birth defects or other reproductive harm. For more information go to www.P65Warnings.ca.gov.

Sleeve 60AB

REF. SAE 120115

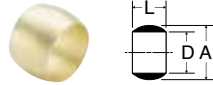

PART NO.	TUBE SIZE	A	D	L
60AB-4	1/4	.322	.255	.250
60AB-6	3/8	.461	.382	.310
60AB-8	1/2	.594	.507	.380
60AB-10	5/8	.734	.632	.440
60AB-12	3/4	.874	.758	.500

Nut 61AB

REF. SAE 120111

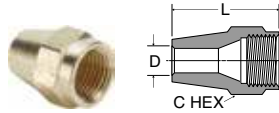

PART NO.	TUBE SIZE	STRAIGHT THREAD	C HEX	D	L
61AB-4	1/4	7/16-24	9/16	.256	.75
61AB-6	3/8	17/32-24	5/8	.384	1.13
61AB-8	1/2	11/16-20	13/16	.509	1.25
61AB-10	5/8	13/16-18	15/16	.634	1.38
61AB-12	3/4	1-18	1-1/8	.760	1.56

Union 62AB

REF. SAE 120101 BA

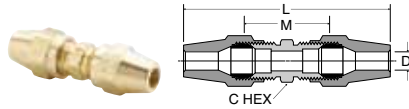

PART NO.	TUBE SIZE	STRAIGHT THREAD	C HEX	L	M	FLOW DIA. D
62AB-4	1/4	7/16-24	7/16	1.98	.83	.189
62AB-6	3/8	17/32-24	9/16	2.87	1.08	.314
62AB-8	1/2	11/16-20	11/16	3.21	1.29	.405
62AB-10	5/8	13/16-18	13/16	3.59	1.41	.531
62AB-12	3/4	1-18	1	4.08	1.59	.656

Bulkhead Union 62ABH

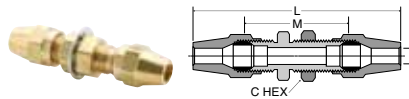

PART NO.	TUBE SIZE	STRAIGHT THREAD	C HEX	L	M	FLOW DIA. D	BULKHEAD HOLE DIA.
62ABH-4	1/4	7/16-24	9/16	2.53	1.38	.188	7/16
62ABH-6	3/8	17/32-24	3/4	3.41	1.62	.314	17/32
62ABH-8	1/2	11/16-20	1	3.80	1.88	.408	11/16

Female Connector 66AB

REF. SAE 120103 BA

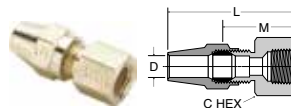

PART NO.	TUBE SIZE	PIPE THREAD	STRAIGHT THREAD	C HEX	L	M	FLOW DIA. D
66AB-4-2	1/4	1/8	7/16-24	9/16	1.42	.84	.188
66AB-4-4	1/4	1/4	7/16-24	11/16	1.65	1.07	.188
66AB-6-2	3/8	1/8	17/32-24	9/16	1.89	1.00	.314
66AB-6-4	3/8	1/4	17/32-24	11/16	2.07	1.18	.314
66AB-6-6	3/8	3/8	17/32-24	7/8	2.07	1.18	.314
66AB-8-6	1/2	3/8	11/16-20	7/8	2.23	1.27	.408
66AB-8-8	1/2	1/2	11/16-20	1-1/16	2.40	1.44	.408
66AB-10-6	5/8	3/8	13/16-18	7/8	2.40	1.31	.533
66AB-10-8	5/8	1/2	13/16-18	1-1/16	2.59	1.50	.533

Male Connector VS68AB

REF. SAE 120102 BA

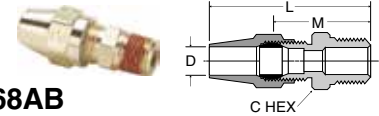

PART NO.	TUBE SIZE	PIPE THREAD	STRAIGHT THREAD	C HEX	L	M	FLOW DIA. D
VS68AB-4-2	1/4	1/8	7/16-24	7/16	1.47	.89	.189
VS68AB-4-4	1/4	1/4	7/16-24	9/16	1.68	1.10	.189
VS68AB-4-6	1/4	3/8	7/16-24	11/16	1.72	1.14	.189
VS68AB-6-2	3/8	1/8	17/32-24	9/16	1.92	1.03	.189
VS68AB-6-4	3/8	1/4	17/32-24	9/16	2.10	1.21	.314
VS68AB-6-6	3/8	3/8	17/32-24	11/16	2.13	1.24	.314
VS68AB-6-8	3/8	1/2	17/32-24	7/8	2.32	1.43	.314
VS68AB-8-4	1/2	1/4	11/16-20	11/16	2.29	1.33	.314
VS68AB-8-6	1/2	3/8	11/16-20	11/16	2.29	1.33	.408
VS68AB-8-8	1/2	1/2	11/16-20	7/8	2.48	1.52	.408
VS68AB-10-6	5/8	3/8	13/16-18	13/16	2.48	1.39	.408
VS68AB-10-8	5/8	1/2	13/16-18	7/8	2.67	1.58	.533
VS68AB-12-8	3/4	1/2	1-18	1	2.92	1.68	.533
VS68AB-12-12	3/4	3/4	1-18	1-1/8	2.95	1.71	.658

Union Tee 264AB

REF. SAE 120401 BA

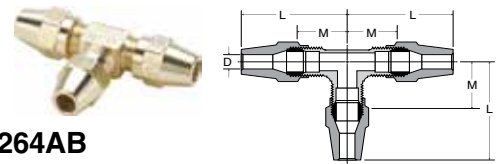

PART NO.	TUBE SIZE	STRAIGHT THREAD	L	M	FLOW DIA. D
264AB-4	1/4	7/16-24	1.20	.62	.189
264AB-6	3/8	17/32-24	1.67	.78	.314
264AB-8	1/2	11/16-20	1.89	.93	.408
264AB-10	5/8	13/16-18	2.18	1.09	.533

Union Elbow 265AB

REF. SAE 120201 BA

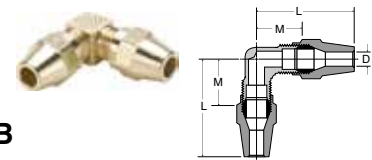

PART NO.	TUBE SIZE	STRAIGHT THREAD	L	M	FLOW DIA. D
265AB-4	1/4	7/16-24	1.20	.62	.189
265AB-6	3/8	17/32-24	1.68	.79	.314
265AB-8	1/2	11/16-20	1.89	.93	.408
265AB-10	5/8	13/16-18	2.18	1.09	.533

WARNING These products can expose you to chemicals including LEAD which is known to the state of California to cause cancer and birth defects or other reproductive harm. For more information go to www.P65Warnings.ca.gov.



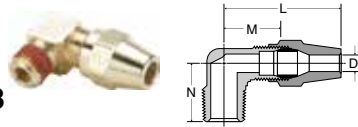

Male Elbow VS269AB

REF. SAE 120202 BA

PART NO.	TUBE SIZE	PIPE THREAD	STRAIGHT THREAD	L	M	N	FLOW DIA. D
VS269AB-4-2	1/4	1/8	7/16-24	1.20	.62	.66	.189
VS269AB-4-4	1/4	1/4	7/16-24	1.26	.68	.87	.189
VS269AB-4-6	1/4	3/8	7/16-24	1.31	.73	.86	.189
VS269AB-6-2	3/8	1/8	17/32-24	1.62	.73	.75	.189
VS269AB-6-4	3/8	1/4	17/32-24	1.68	.79	.92	.314
VS269AB-6-6	3/8	3/8	17/32-24	1.73	.84	.91	.314
VS269AB-6-8	3/8	1/2	17/32-24	1.83	.94	1.10	.314
VS269AB-8-4	1/2	1/4	11/16-20	1.82	.86	.99	.314
VS269AB-8-6	1/2	3/8	11/16-20	1.88	.93	.99	.408
VS269AB-8-8	1/2	1/2	11/16-20	1.99	1.03	1.18	.408
VS269AB-10-6	5/8	3/8	13/16-18	2.09	1.00	1.05	.408
VS269AB-10-8	5/8	1/2	13/16-18	2.18	1.09	1.24	.533
VS269AB-12-8	3/4	1/2	1-18	2.33	1.19	1.32	.533
VS269AB-12-12	3/4	3/4	1-18	2.50	1.26	1.32	.533

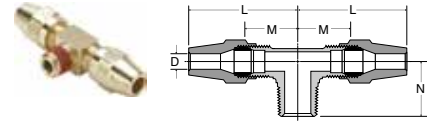

Male Branch Tee VS272AB

REF. SAE 120425 BA

PART NO.	TUBE SIZE	PIPE THREAD	STRAIGHT THREAD	L	M	N	FLOW DIA. D
VS272AB-4-2	1/4	1/8	7/16-24	1.20	.62	.66	.189
VS272AB-4-4	1/4	1/4	7/16-24	1.26	.68	.87	.189
VS272AB-6-2	3/8	1/8	17/32-24	1.61	.72	.75	.189
VS272AB-6-4	3/8	1/4	17/32-24	1.68	.79	.92	.314
VS272AB-6-6	3/8	3/8	17/32-24	1.73	.84	.91	.314
VS272AB-8-6	1/2	3/8	11/16-20	1.89	.93	.99	.408
VS272AB-8-8	1/2	1/2	11/16-20	1.99	1.03	1.18	.408
VS272AB-10-8	5/8	1/2	13/16-18	2.18	1.09	1.24	.533

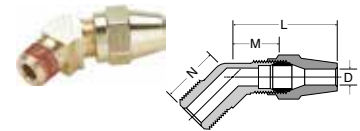

45° Elbow VS279AB

REF. SAE 120302 BA

PART NO.	TUBE SIZE	PIPE THREAD	STRAIGHT THREAD	L	M	N	FLOW DIA. D
VS279AB-4-2	1/4	1/8	7/16-24	1.07	.49	.63	.189
VS279AB-4-4	1/4	1/4	7/16-24	1.18	.60	.85	.189
VS279AB-6-2	3/8	1/8	17/32-24	1.60	.71	.68	.189
VS279AB-6-4	3/8	1/4	17/32-24	1.64	.71	.85	.314
VS279AB-6-6	3/8	3/8	17/32-24	1.64	.75	.94	.314
VS279AB-6-8	3/8	1/2	17/32-24	1.67	.78	1.16	.314
VS279AB-8-6	1/2	3/8	11/16-20	1.80	.84	.94	.408
VS279AB-8-8	1/2	1/2	11/16-20	1.83	.87	1.16	.408
VS279AB-10-6	5/8	3/8	13/16-18	2.03	.94	.98	.408
VS279AB-10-8	5/8	1/2	13/16-18	2.13	1.05	1.16	.533
VS279AB-12-8	3/4	1/2	1-18	2.34	1.10	1.18	.533

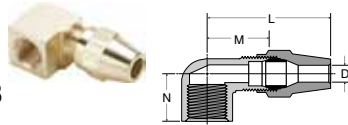

Female Elbow 270AB

REF. SAE 120203 BA

PART NO.	TUBE SIZE	PIPE THREAD	STRAIGHT THREAD	L	M	N	FLOW DIA. D
270AB-4-2	1/4	1/8	7/16-24	1.27	.69	.52	.189
270AB-4-4	1/4	1/4	7/16-24	1.36	.78	.71	.189
270AB-6-2	3/8	1/8	17/32-24	1.72	.83	.59	.314
270AB-6-4	3/8	1/4	17/32-24	1.78	.89	.77	.314
270AB-6-6	3/8	3/8	17/32-24	1.82	.93	.77	.314
270AB-8-6	1/2	3/8	11/16-20	1.99	1.03	.82	.408
270AB-8-8	1/2	1/2	11/16-20	2.09	1.13	1.01	.408
270AB-10-8	5/8	1/2	13/16-18	2.28	1.19	1.07	.533

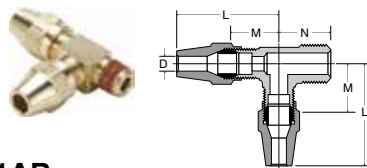

Male Run Tee VS271AB

REF. SAE 120424 BA

PART NO.	TUBE SIZE	PIPE THREAD	STRAIGHT THREAD	L	M	N	FLOW DIA. D
VS271AB-4-2	1/4	1/8	7/16-24	1.20	.62	.66	.189
VS271AB-4-4	1/4	1/4	7/16-24	1.26	.68	.87	.189
VS271AB-6-4	3/8	1/4	17/32-24	1.68	.79	.92	.314
VS271AB-6-6	3/8	3/8	17/32-24	1.73	.84	.91	.314
VS271AB-8-6	1/2	3/8	11/16-20	1.89	.93	.99	.408
VS271AB-8-8	1/2	1/2	11/16-20	1.99	1.03	1.18	.408
VS271AB-10-8	5/8	1/2	13/16-18	2.18	1.09	1.24	.533

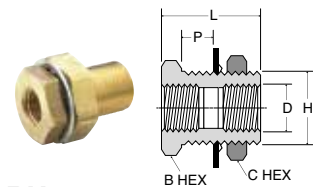

Anchor Coupling 207ACBH

PART NO.	FEMALE PIPE THREAD	STRAIGHT THREAD	MAX. BKHD P	B HEX	C HEX	L	BKHD HOLE DIA. H	FLOW DIA. D
207ACBH-2	1/8	5/8-18	.89	7/8	15/16	1.50	5/8	.339
207ACBHS-2	1/8	5/8-18	.35	7/8	15/16	.96	5/8	.339
207ACBH-4	1/4	3/4-16	.81	1	1-1/8	1.50	3/4	.441
207ACBHS-4	1/4	3/4-16	.26	1	1	.94	3/4	.441
207ACBH-6	3/8	1-14	.62	1-1/8	1-1/4	1.31	1	.571
207ACBH-8	1/2	1-1/8-14	.75	1-1/4	1-3/8	1.50	1-1/8	.703
207ACBH-12	3/4	1-5/16-12	.65	1-1/2	1-1/2	1.50	1-5/16	.906
207ACBH-16*	1	1-5/8-14	1.00	2	2	1.68	1-5/8	1.140

*Lock Washer not Available

WARNING These products can expose you to chemicals including LEAD which is known to the state of California to cause cancer and birth defects or other reproductive harm. For more information go to www.P65Warnings.ca.gov.

Air Brake Hose Ends Fittings



Parker's Air Brake Hose Fittings are field attachable fittings for use with Parker 271 air brake hose. Easy to assemble and disassemble, these fittings meet D.O.T. requirements when used with SAE J1402 air brake hose.

Product Features:

- Brass Body
- Meets D.O.T. FMVSS571.106 when used with SAE J1402 air brake hose

Markets:

- Heavy Duty Truck
- Trailer

Applications:

- Air Lines Frame to Axle

Specifications:

Pressure Range Up to 400 PSI (27.5 bar)

Temperature Range -65° to +250° F (-53.8° to +121.1° C)

Compatible Tubing:

- Parker 271 air brake hose
- SAE J1402 air brake hose

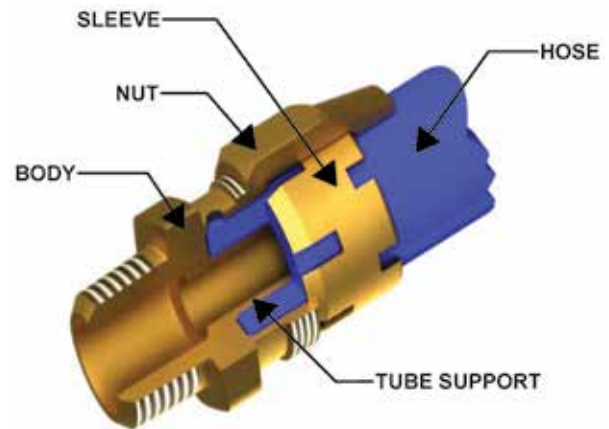

Assembly Instructions

1. Slide nut onto hose
2. Slide sleeve onto hose with tapered edge toward fitting body
3. Bottom hose into fitting
4. Tighten nut until it contacts body hex



Note: When reassembling fitting, body and nut should be inspected. Only reuse if parts are in proper condition. Sleeves should never be Reused.

WARNING These products can expose you to chemicals including NICKEL or LEAD, which are known to the state of California to cause cancer, and LEAD which is known to cause birth defects or other reproductive harm. For more information go to www.P65Warnings.ca.gov.



Spring 56RBSG

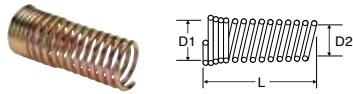

PART NO.	HOSE SIZE	L	D1	D2
56RBSG-6	3/8	2.75	.84	.78
56RBSG-8	1/2	3.00	1.03	.91

Air Brake Hose Nut & Attached Spring 67RBSG

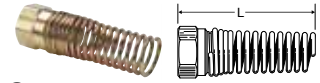

PART NO.	L
67RBSG-6	3.50
67RBSG-8	3.75

Sleeve 60RB

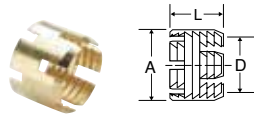

PART NO.	HOSE SIZE	L	A	D
60RB-6	3/8	.69	.90	.78
60RB-8	1/2	.69	1.03	.92

Male Connector 68RB

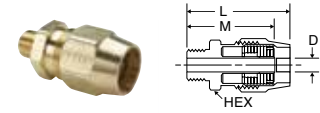

PART NO.	HOSE SIZE	STRAIGHT THREAD	PIPE THREAD	HEX	L	M	D
68RB-6-4	3/8	31/32-20	1/4	31/32	2.24	1.91	.281
68RB-6-6	3/8	31/32-20	3/8	31/32	2.24	1.91	.281
68RB-6-8	3/8	31/32-20	1/2	31/32	2.38	2.06	.281
68RB-8-6	1/2	1-3/32-20	3/8	1-1/8	2.24	1.91	.390
68RB-8-8	1/2	1-3/32-20	1/2	1-1/8	2.29	2.07	.390

Nut 61RB

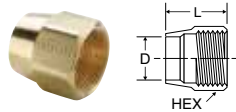

PART NO.	HOSE SIZE	STRAIGHT THREAD	HEX	L	D
61RB-6	3/8	31/32-20	1-1/16	1.12	.80
61RB-8	1/2	1-3/32-20	1-1/4	1.12	.93

Male Connector Body Only 68RB

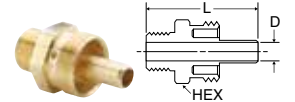

PART NO.	HOSE SIZE	STRAIGHT THREAD	PIPE THREAD	HEX	L	D
68RB-6-4B	3/8	31/32-20	1/4	31/32	1.91	.281
68RB-6-6B	3/8	31/32-20	3/8	31/32	1.91	.281
68RB-6-8B	3/8	31/32-20	1/2	31/32	2.06	.281
68RB-8-6B	1/2	1-3/32-20	3/8	1-1/8	1.91	.390
68RB-8-8B	1/2	1-3/32-20	1/2	1-1/8	2.07	.390

Spring Guard Nut 61RBSG

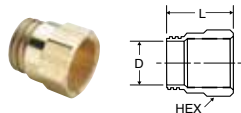

PART NO.	HOSE SIZE	STRAIGHT THREAD	HEX	L	D
61RBSG-6	3/8	31/32-20	1-1/16	1.22	.80
61RBSG-8	1/2	1-3/32-20	1-1/4	1.19	.92

Male Connector with Spring Guard 68RBSG

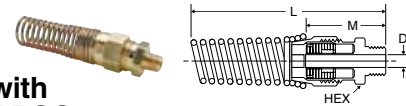

PART NO.	HOSE SIZE	PIPE THREAD	HEX	L	M	D
68RBSG-6-4	3/8	1/4	31/32	4.8	1.91	.281
68RBSG-6-6	3/8	3/8	31/32	4.8	1.91	.281
68RBSG-6-8	3/8	1/2	31/32	4.9	2.06	.281
68RBSG-8-6	1/2	3/8	1-1/8	5.0	1.91	.390
68RBSG-8-8	1/2	1/2	1-1/8	5.2	2.07	.390

Union 62RB

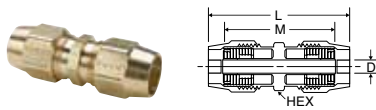

PART NO.	HOSE SIZE	STRAIGHT THREAD	HEX	L	M	D
62RB-6	3/8	31/32-20	31/32	2.98	2.56	.281
62RB-8	1/2	1-3/32-20	1-1/8	2.99	2.55	.390

Female Swivel Connector 66RBSV

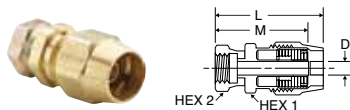

PART NO.	HOSE SIZE	STRAIGHT THREAD	HEX1	HEX2	L	M	D
66RBSV-6-3/4	3/8	3/4-20	31/32	7/8	2.30	2.09	.281
66RBSV-8-7/8	1/2	7/8-20	1-1/8	1"	2.36	2.14	.390

Adapter 76RB

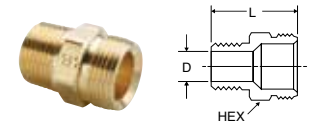

PART NO.	PIPE THREAD	STRAIGHT THREAD	HEX	L	D
76RB-3/4-4	1/4	3/4-20	3/4	1.06	.310
76RB-3/4-6	3/8	3/4-20	3/4	1.12	.422
76RB-7/8-6	3/8	7/8-20	7/8	1.25	.440
76RB-7/8-8	1/2	7/8-20	7/8	1.47	.500

WARNING These products can expose you to chemicals including NICKEL or LEAD, which are known to the state of California to cause cancer, and LEAD which is known to cause birth defects or other reproductive harm. For more information go to www.P65Warnings.ca.gov.



Vibra-Lok Fittings



Parker's Vibra-Lok Fittings provide a positive reliable seal under vibration conditions, mechanical shock or tube movement. The sleeve cushions the tubing, permitting the tubing to flex back and forth in the fitting. The seal design compensates for tube misalignment and tube surface defects.

Product Features:

- Brass Body
- Sleeves in Buna N and Fluorocarbon
- NPTF and SAE J1926 Straight Threads are Standard
- Excellent Vibration Resistance

Markets:

- Heavy Duty Truck
- Trailer
- Mobile

Applications:

- Oil, Fuel and Coolant Lines on engines

Specifications:

Pressure Range Dependent on condition and tube size, refer to pressure chart

-15° to +450° F (-26.1° to +232.2° C)
with Fluorocarbon Sleeve

Temperature Range

-30° to +275° F (-34.4° to +135° C)
with Buna N Sleeve

Compatible Tubing:

- Copper
- Aluminum
- Steel (Bundy)
- Stainless Steel
- Glass

Pressure Chart

CONDITION	TUBE O.D.	TUBE NOT BELLED	TUBE BELLED OR FLARED
STATIC PRESSURE	3/16"	500	1000
	1/4"	500	1000
	5/16"	450	900
	3/8"	350	700
	1/2"	200	500
	5/8"		400
MINOR SURGES AND/OR VIBRATIONS	3/16"	400	800
	1/4"	400	800
	5/16"	325	700
	3/8"	225	500
	1/2"	150	375
	5/8"		300
SEVERE VIBRATIONS OR SHOCK	3/16"	300	600
	1/4"	300	600
	5/16"	225	500
	3/8"	175	400
	1/2"	100	250
	5/8"		100

In high pressure applications and sizes larger than 1/2" O.D., the tube end should be belled or flared.

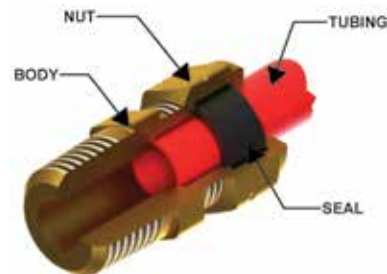

WARNING These products can expose you to chemicals including CARBON BLACK, or LEAD, which are known to the state of California to cause cancer, and LEAD which is known to cause birth defects or other reproductive harm. For more information go to www.P65Warnings.ca.gov.



Assembly Instructions

1. Cut the tubing squarely removing burrs
2. Slip nut and sleeve over tube
3. Bottom tubing into fitting and tighten nut until stop is reached. The elastic sleeve ordinarily will extrude slightly around the tube at the end of the nut. This extrusion further aids in isolating the tube from the nut.



For Higher Pressure applications

4. Consult pressure chart to determine if tubing should be belled
5. Slip nut and sleeve over tube. The sleeve should be positioned near end of tubing just behind the surface to be belled
6. Bell tubing with standard 45° flaring tool or 90° punch. The size of bell should be approximately that shown.



Recommended Size of Bell

TUBE O.D.	BELL DIA. C
1/8	.190-.160
3/16	.255-.225
1/4	.318-.288
5/16	.381-.351
3/8	.444-.414
1/2	.569-.539
5/8	.694-.664
3/4	.819-.789
7/8	.944-.914

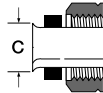

Tube Length Calculator

This table shows distance tube extends beyond face of Vibra-Lok fitting body on installation with bell on tubing and without bell on tubing.

O.D. OF TUBE	A WITH BELL	B WITHOUT BELL
1/8	3/16	3/16
3/16	3/16	7/32
1/4	3/16	1/4
5/16	3/16	1/4
3/8	3/16	1/4
1/2	3/16	11/32
5/8	3/16	TUBING SHOULD BE BELLED
3/4	3/16	
7/8	1/4	

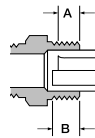

Sleeve 60VL



PART NO.	TUBE SIZE	A	D	L
60VL-2	1/8	.306	.100	.20
60VL-3	3/16	.359	.156	.20
60VL-4	1/4	.422	.219	.21
60VL-5	5/16	.484	.281	.24
60VL-6	3/8	.547	.344	.25
60VL-8	1/2	.688	.469	.36
60VL-10	5/8	.875	.594	.48
60VL-12	3/4	1.000	.720	.59

Sleeve (Fluorocarbon) 60VLV

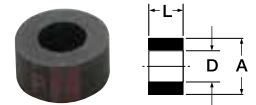

PART NO.	TUBE SIZE	A	D	L
60VLV-3	3/16	.359	.156	.20
60VLV-4	1/4	.422	.219	.21
60VLV-5	5/16	.484	.281	.24
60VLV-6	3/8	.547	.344	.25
60VLV-8	1/2	.688	.469	.36
60VLV-10	5/8	.875	.594	.48
60VLV-12	3/4	1.000	.720	.59

Nut 61VL

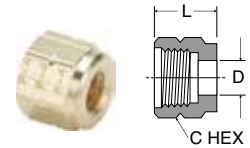

PART NO.	TUBE SIZE	STRAIGHT THREAD	C HEX	D	L
61VL-2	1/8	3/8-24	7/16	.156	.44
61VL-3	3/16	7/16-24	1/2	.218	.47
61VL-4	1/4	1/2-24	9/16	.281	.50
61VL-5	5/16	9/16-24	5/8	.344	.53
61VL-6	3/8	5/8-24	3/4	.406	.53
61VL-8	1/2	13/16-18	15/16	.531	.67
61VL-10	5/8	1-18	1-1/8	.656	.88
61VL-12	3/4	1-1/8-18	1-1/4	.781	.98

Union 62VL

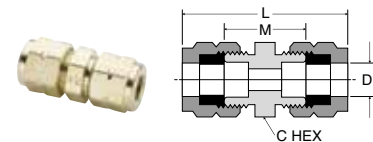

PART NO.	TUBE SIZE	C HEX	L	M	FLOW DIA. D
62VL-4	1/4	9/16	1.39	.77	.188
62VL-5	5/16	5/8	1.49	.81	.250
62VL-6	3/8	11/16	1.49	.80	.312
62VL-8	1/2	7/8	1.90	.94	.437

WARNING These products can expose you to chemicals including CARBON BLACK, or LEAD, which are known to the state of California to cause cancer, and LEAD which is known to cause birth defects or other reproductive harm. For more information go to www.P65Warnings.ca.gov.



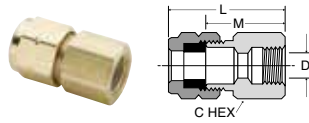

Female Connector 66VL

PART NO.	TUBE SIZE	PIPE THREAD	C HEX	L	M	FLOW DIA. D
66VL-4-2	1/4	1/8	9/16	1.09	.78	.188
66VL-5-4	5/16	1/4	11/16	1.32	.97	.250

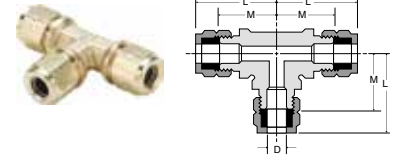

Union Tee 164VL

PART NO.	TUBE SIZE	BODY HEX	L	M	FLOW DIA. D
164VL-3	3/16	3/8	.98	.69	.160
164VL-4	1/4	1/2	1.06	.75	.190
164VL-5	5/16	15/32	1.22	.88	.250
164VL-8	1/2	13/16	1.64	1.16	.406

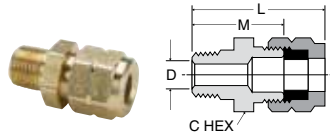

Male Connector 68VL

PART NO.	TUBE SIZE	PIPE THREAD	C HEX	L	M	FLOW DIA. D
68VL-2-2	1/8	1/8	7/16	1.12	.81	.093
68VL-3-2	3/16	1/8	1/2	1.10	.81	.125
68VL-4-2	1/4	1/8	9/16	1.15	.84	.188
68VL-4-4	1/4	1/4	9/16	1.34	1.03	.188
68VL-5-4	5/16	1/4	5/8	1.41	1.06	.250
68VL-6-2	3/8	1/8	11/16	1.22	.87	.235
68VL-6-4	3/8	1/4	11/16	1.41	1.06	.312
68VL-6-6	3/8	3/8	11/16	1.41	1.06	.312
68VL-8-6	1/2	3/8	7/8	1.64	1.16	.406
68VL-8-8	1/2	1/2	7/8	1.64	1.35	.406
68VL-10-8	5/8	1/2	1-1/16	2.10	1.44	.560
68VL-12-8	3/4	1/2	1-3/16	2.26	1.50	.530
68VL-12-12	3/4	3/4	1-3/16	2.26	1.50	.688

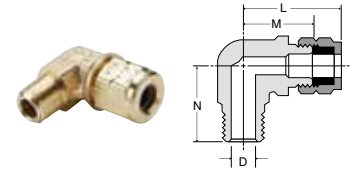

Male Elbow 169VL

PART NO.	TUBE SIZE	PIPE THREAD	L	M	N	FLOW DIA. D
169VL-3-2	3/16	1/8	.98	.69	.75	.156
169VL-4-2	1/4	1/8	1.00	.69	.78	.188
169VL-4-4	1/4	1/4	1.16	.84	1.00	.188
169VL-5-4	5/16	1/4	1.16	.81	1.00	.252
169VL-6-2	3/8	1/8	1.19	.84	.91	.235
169VL-6-4	3/8	1/4	1.19	.84	1.06	.312
169VL-6-6	3/8	3/8	1.29	.94	1.13	.312
169VL-8-6	1/2	3/8	1.48	1.00	1.06	.406
169VL-8-8	1/2	1/2	1.54	1.06	1.44	.406
169VL-10-8	5/8	1/2	1.92	1.28	1.47	.565

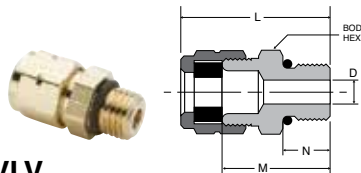

Male Connector 685VLV

PART NO.	TUBE SIZE	STRAIGHT THREAD	BODY HEX	L	M	N	D
685VLV-4-4	1/4	7/16-20	9/16	1.14	.83	.36	.18
685VLV-5-4	5/16	7/16-20	5/8	1.18	.83	.36	.18
685VLV-6-4	3/8	7/16-20	11/16	1.18	.83	.36	.18
685VLV-6-6	3/8	9/16-18	11/16	1.25	.90	.39	.30
685VLV-8-8	1/2	3/4-16	7/8	1.52	1.04	.44	.39
685VLV-10-10	5/8	7/8-14	1 1/16	1.84	1.20	.50	.50
685VLV-12-12	3/4	1 1/16-12	1 1/4	2.10	1.34	.59	.62

Note: Fluorocarbon seal & o-ring standard

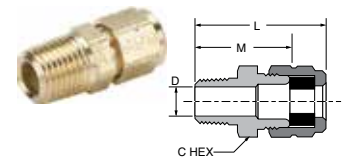

Straight Through Tank Fitting 682VL

PART NO.	TUBE SIZE	PIPE THREAD	C HEX	L	M	FLOW DIA. D
682VL-4-2	1/4	1/8	9/16	1.15	.84	.265
682VL-4-4	1/4	1/4	9/16	1.34	1.03	.265
682VL-5-4	5/16	1/4	5/8	1.41	1.06	.328
682VL-6-6	3/8	3/8	11/16	1.41	1.06	.406

WARNING These products can expose you to chemicals including CARBON BLACK, or LEAD, which are known to the state of California to cause cancer, and LEAD which is known to cause birth defects or other reproductive harm. For more information go to www.P65Warnings.ca.gov.

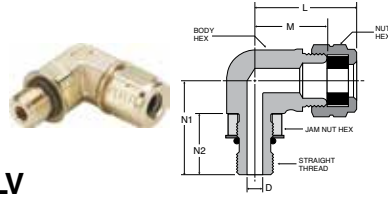

Male Elbow 1695VLV

PART NO.	TUBE SIZE	STRAIGHT THREAD	NUT HEX	BODY HEX	JAM NUT HEX	L	M	N1	N2	D
1695VLV-4-4	1/4	7/16-20	9/16	9/16	9/16	1.15	.84	1.07	.71	.18
1695VLV-5-4	5/16	7/16-20	5/8	9/16	9/16	1.16	.81	1.07	.71	.18
1695VLV-6-4	3/8	7/16-20	3/4	5/8	9/16	1.19	.84	1.10	.71	.18
1695VLV-6-6	3/8	9/16-18	3/4	5/8	11/16	1.29	.94	1.17	.78	.30
1695VLV-8-8	1/2	3/4-16	15/16	3/4	7/8	1.54	1.06	1.44	.89	.39
1695VLV-10-10	5/8	7/8-14	1 1/8	1.00	1.00	1.92	1.28	1.68	1.03	.50
1695VLV-12-12	3/4	1 1/16-12	1 1/4	1.00	1 1/4	2.04	1.28	1.82	1.17	.62

Note: Fluorocarbon seal & o-ring standard

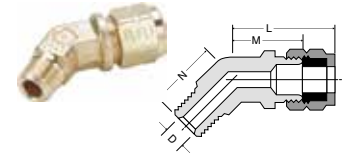

45° Elbow 179VL

PART NO.	TUBE SIZE	PIPE THREAD	L	M	N	FLOW DIA. D
179VL-4-2	1/4	1/8	1.06	.75	.69	.188
179VL-6-4	3/8	1/4	1.07	.72	.84	.315

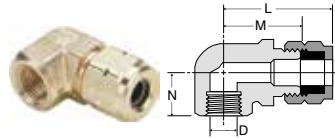

Female Elbow 170VL

PART NO.	TUBE SIZE	PIPE THREAD	L	M	N	FLOW DIA. D
170VL-4-2	1/4	1/8	.96	.65	.50	.188
170VL-5-4	5/16	1/4	1.16	.81	.70	.250

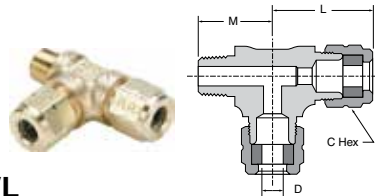

Male Run Tee 171VL

PART NO.	TUBE SIZE	PIPE THREAD	C HEX	L	M	FLOW DIA. D
171VL-4-2	1/4	1/8	9/16	1.03	.76	.188
171VL-4-4	1/4	1/4	9/16	1.12	1.03	.188

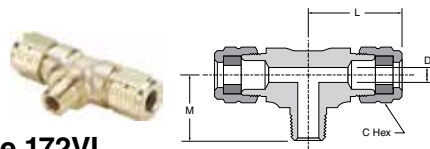

Male Branch Tee 172VL

PART NO.	TUBE SIZE	PIPE THREAD	C HEX	L	M	FLOW DIA. D
172VL-4-2	1/4	1/8	9/16	1.06	.75	.188

WARNING These products can expose you to chemicals including CARBON BLACK, or LEAD, which are known to the state of California to cause cancer, and LEAD which is known to cause birth defects or other reproductive harm. For more information go to www.P65Warnings.ca.gov.

Truck Valves & Lanyard Valve



Parker's Truck Valves have metal-to-metal seats with fine thread screwdown. Parker's Lanyard Valves' compact design is ideally suited for releasing condensate from air tanks.

Product Features:

Truck Valves

- Brass Body and Stem
- Flare, Hose, Tube and Pipe Connections
- Round and Pin Handles

Lanyard Valve

- Low Temperature Seal
- All Brass Body
- Manual Release

Markets:

- Heavy Duty Truck
- Trailer
- Mobile

Applications:

- Water
- Oil
- Coolant lines

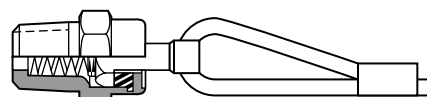

Truck Valve Specifications:

Pressure Range Up to 150 PSI (10.3 bar)

Temperature Range -30° to +250° F (-34.4° to +121.1° C)

Lanyard Valve Specifications:

Pressure Range Up to 150 PSI (10.3 bar)

Temperature Range -40° to +200° F (-40° to +93.3° C)

Lanyard Valve Operating Instructions

A pulling action exerted on the cable cocks the stem, allowing condensate to pass through the valve. Releasing the cable resets the stem which returns the valve to its closed position.

WARNING These products can expose you to chemicals including LEAD which is known to the state of California to cause cancer and birth defects or other reproductive harm. For more information go to www.P65Warnings.ca.gov.



Truck Valve V404P

Hose to Male Pipe

Temperature Range: -30° to +250° F (-34.4° to +121.1° C)

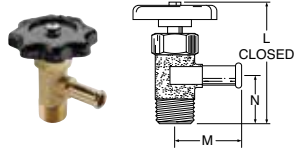

PART NO.	HOSE I.D.	PIPE THREAD	FLOW	L	M	N
V404P-6-6	3/8	3/8	.281	2.35	1.36	.94
V404P-10-6	5/8	3/8	.406	2.75	1.31	1.10

Truck Valve V404PH

Hose to Male Pipe with Pin Handle

Temperature Range: -30° to +250° F (-34.4° to +121.1° C)

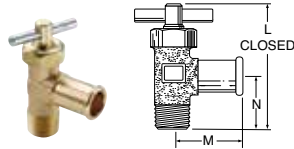

PART NO.	HOSE I.D.	PIPE THREAD	FLOW	L	M	N
V404PH-10-6	5/8	3/8	.406	2.47	1.31	1.10

Truck Valve SV404P

Hose to Male Pipe

Temperature Range: -30° to +250° F (-34.4° to +121.1° C)

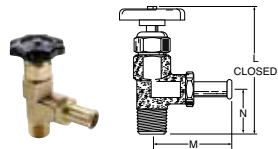

PART NO.	HOSE I.D.	PIPE THREAD	FLOW	L	M	N
SV404P-10-8	5/8	1/2	.468	3.71	2.31	1.34
SV404P-12-6	3/4	3/8	.438	3.73	2.31	1.34
SV404P-12-8	3/4	1/2	.562	3.73	2.31	1.34

Truck Valve V405P

Female Pipe to Male Pipe

Temperature Range: -30° to +250° F (-34.4° to +121.1° C)

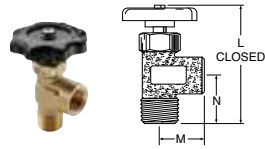

PART NO.	FEMALE PIPE THREAD	MALE PIPE THREAD	FLOW	L	M	N
V405P-6-6	3/8	3/8	.406	2.72	.91	1.19
V405P-6-8	3/8	1/2	.406	2.95	.91	1.31
V405P-8-8	1/2	1/2	.562	3.15	1.17	1.34

Truck Valve V408NTA

Tube to Male Pipe

Temperature Range: -30° to +250° F (-34.4° to +121.1° C)

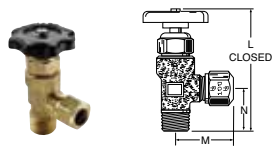

PART NO.	TUBE SIZE	PIPE THREAD	FLOW	L	M	N
V408NTA-8-8	1/2	1/2	.328	3.28	1.15	1.19

Truck Valve V409F

Flare to Male Pipe

Temperature Range: -30° to +250° F (-34.4° to +121.1° C)

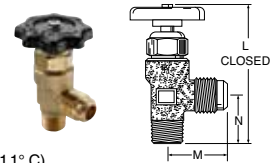

PART NO.	TUBE SIZE	PIPE THREAD	FLOW	L	M	N
V409F-8-6	1/2	3/8	.406	3.07	1.31	1.00
V409F-8-8	1/2	1/2	.406	3.28	1.31	1.19
V409F-10-8	5/8	1/2	.500	3.47	1.50	1.25
V409F-12-8	3/4	1/2	.562	3.70	2.31	1.34

Truck Valve V410NTA

Tube to Male Pipe

Temperature Range: -30° to +250° F (-34.4° to +121.1° C)

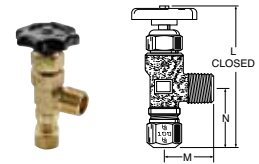

F PART NO.	TUBE SIZE	PIPE THREAD	FLOW	L	M	N
V410NTA-8-8	1/2	1/2	.328	3.58	1.38	1.31

Truck Valve V412F

Tube to Male Pipe

Temperature Range: -30° to +250° F (-34.4° to +121.1° C)

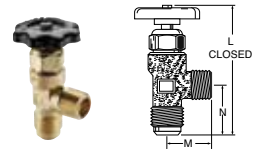

PART NO.	TUBE SIZE	PIPE THREAD	FLOW	L	M	N
V412F-10-8	5/8	1/2	.500	3.60	1.38	1.31

LV91HF-4-SUB

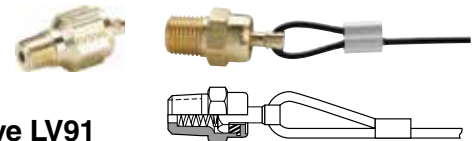

Lanyard Valve LV91

Temperature Range: -40° to +200° F (-40° to +93.3° C)

PART NO.	PIPE THREAD	CABLE LENGTH INCHES
LV91-4-036	1/4	36
LV91-4-048	1/4	48
LV91-4-060	1/4	60
LV91HF-4-SUB	1/4	--

WARNING These products can expose you to chemicals including LEAD which is known to the state of California to cause cancer and birth defects or other reproductive harm. For more information go to www.P65Warnings.ca.gov.



Industrial Compression Style Fittings

Compression Fittings

Compress-Align® Fittings





















































Brass Metric Compression

Poly-Tite Fittings

Hi-Duty Flareless
Tube Fittings























Tube to Male NPTF	68C Male Connector	169C-269C Male Elbow	171C Male Run Tee	172C Male Branch Tee	176C Adaptor	179C 45° Male Elbow	
							
	p. G9	p. G10	p. G11	p. G11	p. G11	p. G11	
	682C Tank Fitting	68CA Male Connector	169CA-269CA Male Elbow	171CA Male Run Tee	172CA Male Branch Tee	176CA Adaptor	179CA 45° Male Elbow
							
	p. G11	p. G14	p. G15	p. G15	p. G15	p. G16	p. G16
	682CA Tank Fitting	68P Male Connector	169P-269P Male Elbow	169LP Long Elbow	169PS Male Elbow Swivel	171P Male Run Tee	172P Male Branch Tee
							
p. G16	p. G30	p. G32	p. G32	p. G32	p. G33	p. G33	
NV311P Needle Valve	NV312P Needle Valve	68HD Male Connector	169HD Male Elbow	171HD Male Run Tee	172HD Male Branch Tee	179HD 45° Male Elbow	
							
p. G33	p. G33	p. G36	p. G36	p. G36	p. G36	p. G36	
Tube to Female NPT	66C Female Connector	170C-270C Female Elbow	177C Female Branch Tee	66CA Female Connector	170CA-270CA Female Elbow	177CA Female Branch Tee	
							
	p. G9	p. G11	p. G11	p. G14	p. G15	p. G16	
	66P Female Connector	170P Female Elbow	177P Female Branch Tee	66HD Female Connector	170HD Female Elbow	177HD Female Branch Tee	Tube to Tube
							
	p. G29	p. G33	p. G33	p. G35	p. G36	p. G37	
	62C Union	164C-264C Union Tee	165C-265C Union Elbow	62CA Union	62PCA Union	164CA-264CA Union Tee	
							
p. G8	p. G10	p. G10	p. G13	p. G13	p. G14	p. G14	
62P Union	62PCA Union	97P Tube Reducer	164P Union Tee	62HD Union	164HD Union Tee	165HD Union Elbow	
							
p. G28	p. G29	p. G30	p. G32	p. G35	p. G35	p. G35	

WARNING These products can expose you to chemicals including NICKEL or LEAD, which are known to the state of California to cause cancer, and LEAD which is known to cause birth defects or other reproductive harm. For more information go to www.P65Warnings.ca.gov.

Bulkhead Union	62CBH Bulkhead Union	62CABH Bulkhead Union	62PCABH Bulkhead Union	62PBH Bulkhead Union	62PCABH Bulkhead Union	62PTBH Bulkhead Union
	 p. G9	 p. G13	 p. G13	 p. G29	 p. G29	 p. G29
62HDBH Bulkhead Union	Couplers	391P Coupler Body	391PSS Coupler Body	392P Bulkhead Body	392PSS Bulkhead Body	393P Through Insert
 p. G35		 p. G30	 p. G30	 p. G30	 p. G30	 p. G30
393PSS Through Insert	393PD Shutoff Insert	393PDSS Shutoff Insert	394P Single Shutoff	394PSS Single Shutoff	394PD Double Shutoff	394PDSS Double Shutoff
 p. G30	 p. G31	 p. G31	 p. G31	 p. G31	 p. G31	 p. G31
398P Single Shutoff	398PSS Single Shutoff	398PD Double Shutoff	398PDSS Double Shutoff	Auxiliary Component	60C Sleeve	60PT Plastic Sleeve
 p. G31	 p. G31	 p. G32	 p. G32		 p. G8	 p. G8
61C Nut	61CL Long Nut	63PT Tube Support	639C Seal Plug	59CA Plug	61CA Nut/Sleeve	639CA Seal Plug
 p. G8	 p. G8	 p. G9,G13	 p. G11	 p. G13	 p. G13	 p. G16
56PSG Spring guard	59P Plug	60P Plastic Sleeve	60PB Brass Sleeve	61P Nut/Plastic Sleeve	61PB Nut/Brass Sleeve	61PN Nut Only
 p. G28	 p. G28	 p. G28	 p. G28	 p. G28	 p. G28	 p. G28
61PSGN Spring Guard Nut	61HD Nut	59HD Plug	0124 Metric Sleeve	0124 40 Metric Steel Sleeve	0111 Metric Sleeve	0110 Metric Nut
 p. G28	 p. G35	 p. G37	 p. G25	 p. G25	 p. G25	 p. G25
0110 40 Metric Nut	0110 60 Metric Nut	0110 70 Metric Nut Sleeve	0127 Metric Tube Support	0125 Metric End Plug	0220 Metric Male Plug	
 p. G25	 p. G25	 p. G26	 p. G26	 p. G26	 p. G26	

WARNING These products can expose you to chemicals including NICKEL or LEAD, which are known to the state of California to cause cancer, and LEAD which is known to cause birth defects or other reproductive harm. For more information go to www.P65Warnings.ca.gov.

Metric Tube to NPT	0105 Male Connector  p. G18	0109 Male Elbow  p. G21			
	0105 Male Connector  p. G18	0109 Male Elbow  p. G20	0108 Male Branch Tee  p. G21	0103 Male Run Tee  p. G22	Male BSPP to Female BSPP  p. G26
Metric Tube to BSPT	0101 Male Elbow  p. G19	0199 Male Elbow  p. G21	Metric Tube to Metric Straight Thread	0101 Male Connector  p. G18	
Metric Tube to BSPP	0106 Union  p. G23	0102 Union Elbow  p. G24	0104 Union Tee  p. G24	0142 Union Y  p. G25	0107 Union Cross  p. G25
Metric Tube to Metric Tube	0116 Bulkhead Union  p. G24	Metric Banjo	0118 Single Banjo  p. G22	0119 Double Banjo  p. G23	
Metric Bulkhead Union					

WARNING These products can expose you to chemicals including NICKEL or LEAD, which are known to the state of California to cause cancer, and LEAD which is known to cause birth defects or other reproductive harm. For more information go to www.P65Warnings.ca.gov.

Compression Fittings



Parker's Compression Fittings provide users with an economical choice with numerous connection options for a wide variety of tube materials without the need for flaring, soldering or other tube preparation necessary to assemble.

Product Features:

- Meets functional requirements of SAE J-512
- UL Listed for flammable liquid
- Brass or acetal sleeve available
- No tube preparation
- Forged and extruded shapes

Markets:

- Industrial
- Packaging
- Pneumatic
- Printing

Applications:

- Air lines
- Lubrication Lines
- Cooling lines
- Industry
- Machinery
- Compressors
- Fluid transfer

Compatible Tubing:

- Copper
- Aluminum
- Thermoplastic tubing

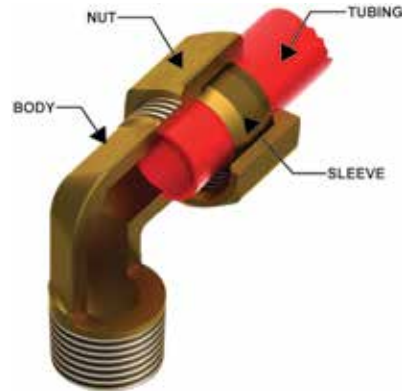

Specifications:

Temperature Range: -65° to +200° F (- 53.8° to +93.3° C)

Pressure Range:

TUBE SIZE	PSI	bar	TUBE SIZE	PSI	bar
1/8	400	27.5	1/2	200	13.7
3/16	400	27.5	5/8	150	10.3
1/4	300	20.6	3/4	100	6.8
5/16	300	20.6	7/8	75	5.1
3/8	200	13.7			

Assembly Instructions

1. Slide nut then sleeve onto tubing. The thread end of the nut must face out.
2. Insert tube and bottom on the fitting shoulder
3. Assemble nut to body and tighten "hand tight". Then wrench tighten the number of turns indicated in the table.



FITTING SIZE	TUBE SIZE	TURNS REQUIRED TO SEAL FROM HAND-TIGHT	
		60C WITH SOFT METAL TUBING	60PT WITH THERMOPLASTIC TUBING
2	1/8	1-1/4	—
3	3/16	1-1/4	—
4	1/4	1-1/4	2
5	5/16	1-1/4	2
6	3/8	2-1/4	2
8	1/2	2-1/4	2
10	5/8	2-1/4	2
12	3/4	2-1/4	2
14	7/8	2-1/4	—

WARNING These products can expose you to chemicals including LEAD which is known to the state of California to cause cancer and birth defects or other reproductive harm. For more information go to www.P65Warnings.ca.gov.

Sleeve 60C

REF. SAE 060115

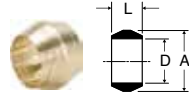

PART NO.	TUBE SIZE	A	D	L
60C-2	1/8	.187	.130	.19
60C-3	3/16	.266	.192	.22
60C-4	1/4	.344	.255	.25
60C-5	5/16	.406	.318	.25
60C-6	3/8	.469	.382	.25
60C-7	7/16	.531	.444	.31
60C-8	1/2	.594	.507	.38
60C-10	5/8	.719	.632	.38
60C-12	3/4	.875	.758	.44
60C-14	7/8	1.000	.883	.41

Long Nut 61CL

REF. SAE 060111

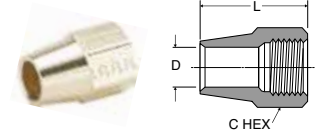

PART NO.	TUBE SIZE	STRAIGHT THREAD	C HEX	D	L
61CL-4	1/4	7/16-24	1/2	.255	.75
61CL-5	5/16	1/2-24	9/16	.318	.84
61CL-6	3/8	9/16-24	5/8	.382	.97
61CL-8	1/2	11/16-20	13/16	.507	1.06
61CL-10	5/8	13/16-18	15/16	.632	1.19
61CL-12	3/4	1-18	1-3/16	.758	1.38

Acetal Sleeve 60PT

PART NO.	PLASTIC TUBE WALL	TUBE WALL	A	D	L
60PT-4	1/4	.040	.375	.254	.19
60PT-5	5/16	.062	.438	.317	.19
60PT-6	3/8	.062	.500	.379	.19
60PT-8	1/2	.062	.631	.507	.25
60PT-10	5/8	.062	.747	.632	.22

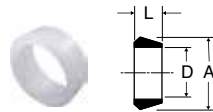

Union 62C

REF. SAE 060101 BA

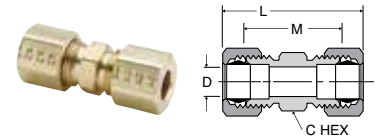

PART NO.	TUBE SIZE	STRAIGHT THREAD	C HEX	L	M	FLOW DIA. D
62C-2	1/8	5/16-24	5/16	1.05	.64	.094
62C-3	3/16	3/8-24	3/8	1.21	.72	.125
62C-4	1/4	7/16-24	7/16	1.33	.79	.188
62C-5	5/16	1/2-24	1/2	1.39	.85	.250
62C-6	3/8	9/16-24	9/16	1.52	.97	.312
62C-7	7/16	5/8-24	5/8	1.70	1.02	.312
62C-8	1/2	11/16-20	11/16	1.90	1.08	.406
62C-10	5/8	13/16-18	13/16	2.06	1.23	.500
62C-12	3/4	1-18	1	2.37	1.41	.562
62C-14	7/8	1-1/8-18	1-1/8	2.07	1.19	.766

Nut 61C

REF. SAE 060110

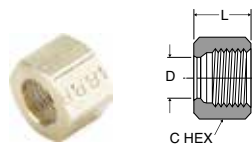

PART NO.	TUBE SIZE	STRAIGHT THREAD	C HEX	D	L
61C-2	1/8	5/16-24	3/8	.130	.38
61C-3	3/16	3/8-24	7/16	.192	.41
61C-4	1/4	7/16-24	1/2	.255	.44
61C-5	5/16	1/2-24	9/16	.318	.44
61C-6	3/8	9/16-24	5/8	.382	.47
61C-7	7/16	5/8-24	11/16	.444	.50
61C-8	1/2	11/16-20	13/16	.507	.62
61C-10	5/8	13/16-18	15/16	.632	.62
61C-12	3/4	1-18	1-3/16	.758	.69
61C-14	7/8	1-1/8-18	1-1/4	.890	.62

Union Reducers 62C

REF. SAE 060101 BA

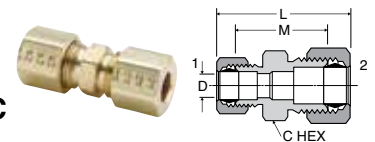

PART NO.	1 TUBE SIZE	2 TUBE SIZE	1 STRAIGHT THREAD	2 STRAIGHT THREAD	C HEX	L	M	FLOW DIA. D
62C-4-3	3/16	1/4	3/8-24	7/16-24	7/16	1.29	.78	.125
62C-6-4	1/4	3/8	7/16-24	9/16-24	9/16	1.46	.91	.188
62C-8-6	3/8	1/2	9/16-24	11/16-20	11/16	1.71	1.03	.312
62C-10-6	3/8	5/8	9/16-24	13/16-18	13/16	1.82	1.13	.312

WARNING These products can expose you to chemicals including LEAD which is known to the state of California to cause cancer and birth defects or other reproductive harm. For more information go to www.P65Warnings.ca.gov.

Bulkhead Union 62CBH

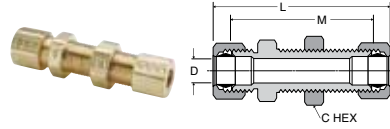

PART NO.	TUBE SIZE	STRAIGHT THREAD	C HEX	L	M	BULKHEAD HOLE DIA.	FLOW DIA. D
62CBH-4	1/4	7/16-24	9/16	2.29	1.75	7/16	.188
62CBH-6	3/8	9/16-24	11/16	2.42	1.88	9/16	.312

Male Connector 68C

REF. SAE 060102 BA

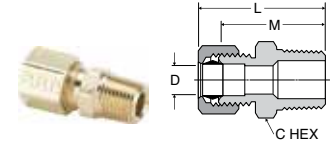

PART NO.	TUBE SIZE	PIPE THREAD	STRAIGHT THREAD	C HEX	L	M	FLOW DIA. D
68C-2-1	1/8	1/16	5/16-24	3/8	.99	.78	.095
68C-2-2	1/8	1/8	5/16-24	7/16	.97	.77	.094
68C-3-1	3/16	1/16	3/8-24	3/8	1.08	.84	.125
68C-3-2	3/16	1/8	3/8-24	7/16	1.08	.84	.125
68C-3-4	3/16	1/4	3/8-24	9/16	1.27	1.03	.125
68C-4-2	1/4	1/8	7/16-24	7/16	1.10	.86	.188
68C-4-4	1/4	1/4	7/16-24	9/16	1.30	1.06	.188
68C-4-6	1/4	3/8	7/16-24	11/16	1.27	1.03	.188
68C-4-8	1/4	1/2	7/16-24	7/8	1.55	1.31	.188
68C-5-2	5/16	1/8	1/2-24	1/2	1.15	.89	.234
68C-5-4	5/16	1/4	1/2-24	9/16	1.33	1.07	.250
68C-6-2	3/8	1/8	9/16-24	9/16	1.25	.97	.250
68C-6-4	3/8	1/4	9/16-24	9/16	1.42	1.14	.312
68C-6-6	3/8	3/8	9/16-24	11/16	1.44	1.16	.312
68C-6-8	3/8	1/2	9/16-24	7/8	1.53	1.25	.312
68C-7-4	7/16	1/4	5/8-24	5/8	1.50	1.17	.312
68C-8-4	1/2	1/4	11/16-20	11/16	1.60	1.20	.312
68C-8-6	1/2	3/8	11/16-20	11/16	1.60	1.20	.406
68C-8-8	1/2	1/2	11/16-20	7/8	1.71	1.31	.406
68C-10-6	5/8	3/8	13/16-18	13/16	1.73	1.31	.406
68C-10-8	5/8	1/2	13/16-18	7/8	1.90	1.48	.500
68C-10-12	5/8	3/4	13/16-18	1-1/16	1.98	1.56	.500
68C-12-8	3/4	1/2	1-18	1	2.05	1.60	.562
68C-12-12	3/4	3/4	1-18	1-1/16	2.08	1.63	.656
68C-14-12	7/8	3/4	1-1/8-18	1-1/8	1.76	1.41	.750

Brass Insert 63PT

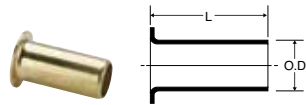

PART NO.	TUBE O.D.	TUBE WALL	L	O.D.
63PT-2-16	1/8	.016	.46	.080
63PT-2-23	1/8	.023	.45	.073
63PT-3-25	3/16	.025	.45	.135
63PT-3-40	3/16	.040	.52	.095
63PT-4-40	1/4	.040	.50	.163
63PT-4-62	1/4	.062	.33	.110
63PT-5-40	5/16	.040	.50	.232
63PT-5-62	5/16	.062	.53	.187
63PT-6-62	3/8	.062	.56	.250
63PT-8-62	1/2	.062	.72	.370
63PT-10-62	5/8	.062	.72	.483

Female Connector 66C

REF. SAE 060103 BA

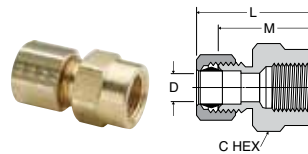

PART NO.	TUBE SIZE	PIPE THREAD	STRAIGHT THREAD	C HEX	L	M	FLOW DIA. D
66C-2-2	1/8	1/8	5/16-24	9/16	.95	.75	.094
66C-3-2	3/16	1/8	3/8-24	9/16	1.02	.78	.125
66C-3-4	3/16	1/4	3/8-24	11/16	1.20	.96	.125
66C-4-2	1/4	1/8	7/16-24	9/16	1.02	.78	.188
66C-4-4	1/4	1/4	7/16-24	11/16	1.24	1.00	.188
66C-5-2	5/16	1/8	1/2-24	9/16	1.07	.81	.250
66C-5-4	5/16	1/4	1/2-24	11/16	1.29	1.03	.250
66C-6-2	3/8	1/8	9/16-24	9/16	1.06	.78	.312
66C-6-4	3/8	1/4	9/16-24	11/16	1.34	1.06	.312
66C-6-6	3/8	3/8	9/16-24	13/16	1.34	1.06	.312
66C-6-8	3/8	1/2	9/16-24	1	1.54	1.27	.312
66C-7-6	7/16	3/8	5/8-24	13/16	1.43	1.09	.312
66C-8-4	1/2	1/4	11/16-20	11/16	1.49	1.09	.406
66C-8-6	1/2	3/8	11/16-20	13/16	1.52	1.12	.406
66C-8-8	1/2	1/2	11/16-20	1	1.71	1.31	.406
66C-10-8	5/8	1/2	13/16-18	1	1.80	1.38	.500

WARNING These products can expose you to chemicals including LEAD which is known to the state of California to cause cancer and birth defects or other reproductive harm. For more information go to www.P65Warnings.ca.gov.

Union Tee 164C-264C

REF. SAE 060401 BA

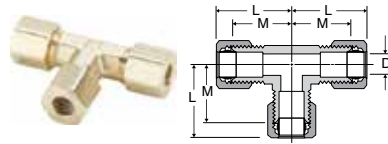

PART NO.	TUBE SIZE	STRAIGHT THREAD	L	M	FLOW DIA. D
164C-2	1/8	5/16-24	.82	.61	.094
264C-3	3/16	3/8-24	.84	.60	.125
164C-4	1/4	7/16-24	.86	.63	.188
264C-4	1/4	7/16-24	.84	.60	.188
164C-5	5/16	1/2-24	.98	.71	.250
164C-6	3/8	9/16-24	1.03	.74	.312
164C-8	1/2	11/16-20	1.34	.93	.406
164C-10	5/8	13/16-18	1.54	1.08	.500
164C-12	3/4	1.00-18	1.65	1.17	.563

Union Tee 164C-264C Combination Sizes

REF. SAE 060401 BA

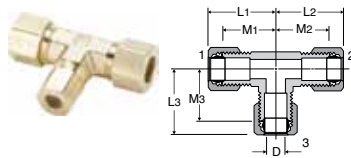

PART NO.	1 TUBE SIZE	2 TUBE SIZE	3 TUBE SIZE	L1	L2	L3	M1	M2	M3	FLOW DIA. D
164C-6-4-4	3/8	1/4	1/4	1.03	.96	.96	.75	.72	.72	.188
164C-6-6-4	3/8	3/8	1/4	1.03	.96	.96	.75	.75	.72	.188
164C-8-8-6	1/2	1/2	3/8	1.34	1.16	1.16	.94	.94	.88	.312

Union Elbow 165C-265C

REF. SAE 060201 BA

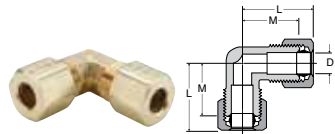

PART NO.	TUBE SIZE	STRAIGHT THREAD	L	M	FLOW DIA. D
165C-2	1/8	5/16-24	.82	.61	.094
165C-3	3/16	3/8-24	.87	.61	.125
165C-4	1/4	7/16-24	.88	.61	.188
265C-4	1/4	7/16-24	.84	.60	.188
165C-5	5/16	1/2-24	.95	.71	.250
165C-6	3/8	9/16-24	1.03	.74	.312
165C-7	7/16	5/8-24	1.16	.82	.312
165C-8	1/2	11/16-20	1.34	.93	.406
165C-10	5/8	13/16-18	1.48	1.05	.500
165C-12	3/4	1-18	1.65	1.17	.563

Male Elbow 169C-269C

REF. SAE 060202 BA

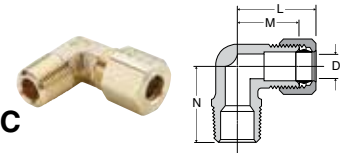

PART NO.	TUBE SIZE	PIPE THREAD	STRAIGHT THREAD	L	M	N	FLOW DIA. D
169C-2-1	1/8	1/16	5/16-24	.81	.60	.67	.095
269C-2-2	1/8	1/8	5/16-24	.80	.60	.67	.094
169C-3-1	3/16	1/16	3/8-24	.85	.61	.67	.126
169C-3-2	3/16	1/8	3/8-24	.84	.61	.69	.125
269C-3-2	3/16	1/8	3/8-24	.84	.60	.67	.125
169C-3-4	3/16	1/4	3/8-24	.86	.64	.93	.125
169C-4-2	1/4	1/8	7/16-24	.86	.61	.74	.188
269C-4-2	1/4	1/8	7/16-24	.84	.60	.73	.188
169C-4-4	1/4	1/4	7/16-24	.86	.62	.94	.188
269C-4-4	1/4	1/4	7/16-24	.84	.60	.79	.188
169C-4-6	1/4	3/8	7/16-24	.93	.68	1.00	.188
169C-5-2*	5/16	1/8	1/2-24	.88	.61	.74	.234
269C-5-2*	5/16	1/8	1/2-24	.86	.60	.73	.250
169C-5-4	5/16	1/4	1/2-24	.95	.71	.93	.250
269C-5-4	5/16	1/4	1/2-24	.93	.67	.82	.250
169C-5-6	5/16	3/8	1/2-24	1.01	.75	1.00	.250
169C-6-2*	3/8	1/8	9/16-24	1.03	.74	.74	.234
269C-6-2*	3/8	1/8	9/16-24	.97	.69	.75	.220
169C-6-4	3/8	1/4	9/16-24	1.03	.74	.93	.312
269C-6-4	3/8	1/4	9/16-24	1.01	.73	.92	.312
169C-6-6	3/8	3/8	9/16-24	1.03	.75	1.00	.312
269C-6-6	3/8	3/8	9/16-24	1.12	.84	.97	.312
169C-6-8	3/8	1/2	9/16-24	1.22	.94	1.27	.312
269C-7-6	7/16	3/8	5/8-24	1.16	.82	.98	.312
169C-8-4*	1/2	1/4	11/16-20	1.34	.94	1.00	.312
169C-8-6	1/2	3/8	11/16-20	1.34	.93	1.11	.406
169C-8-8	1/2	1/2	11/16-20	1.48	1.00	1.37	.406
169C-10-8	5/8	1/2	13/16-18	1.48	1.06	1.31	.500
169C-12-8	3/4	1/2	1-18	1.64	1.18	1.49	.562
169C-12-12	3/4	3/4	1-18	1.70	1.27	1.58	.562

* For these parts the pipe thread through hole is smaller than the through hole on the flare end.

WARNING These products can expose you to chemicals including LEAD which is known to the state of California to cause cancer and birth defects or other reproductive harm. For more information go to www.P65Warnings.ca.gov.

Female Elbow 170C-270C

REF. SAE 060203 BA

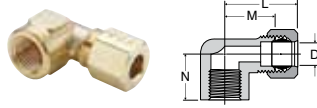

PART NO.	TUBE SIZE	PIPE THREAD	STRAIGHT THREAD	L	M	N	FLOW DIA. D
170C-2-2	1/8	1/8	5/16-24	.89	.69	.56	.094
170C-3-2	3/16	1/8	3/8-24	.98	.69	.56	.125
170C-4-2	1/4	1/8	7/16-24	.93	.69	.56	.188
270C-4-2	1/4	1/8	7/16-24	.91	.67	.54	.188
170C-4-4	1/4	1/4	7/16-24	1.02	.78	.67	.188
170C-6-4	3/8	1/4	9/16-24	1.06	.79	.73	.312
170C-6-6	3/8	3/8	9/16-24	1.22	.89	.69	.312
170C-7-4	7/16	1/4	5/8-24	1.27	.93	.73	.312
170C-8-6	1/2	3/8	11/16-20	1.34	1.00	.69	.406
170C-8-8	1/2	1/2	11/16-20	1.56	1.15	.97	.408
170C-12-12	3/4	3/4	1-18	2.06	1.58	1.58	.563

Adapter Tee 176C

PART NO.	TUBE SIZE	PIPE THREAD	STRAIGHT THREAD	L	M	N	N1	FLOW DIA. D
176C-4-2	1/4	1/8	7/16-24	.93	.69	.75	.66	.188

Female Branch Tee 177C

PART NO.	TUBE SIZE	PIPE THREAD	STRAIGHT THREAD	L	M	N	FLOW DIA. D
177C-4-2	1/4	1/8	7/16-24	.86	.63	.53	.188

45° Elbow 179C

Compression to male pipe

PART NO.	TUBE SIZE	PIPE THREAD	STRAIGHT THREAD	L	M	N	FLOW DIA. D
179C-4-2	1/4	1/8	7/16-24	.90	.66	.56	.188
179C-4-4	1/4	1/4	7/16-24	.80	.56	.84	.188
179C-6-2	3/8	1/8	9/16-24	.90	.63	.65	.234
179C-6-4	3/8	1/4	9/16-24	.90	.63	.84	.312
179C-6-6	3/8	3/8	9/16-24	.97	.75	.95	.312
179C-8-6	1/2	3/8	11/16-20	1.15	.81	.95	.406

Male Run Tee 171C

REF. SAE 060424 BA

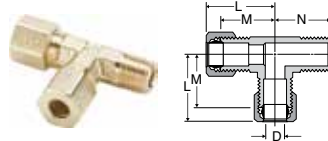

PART NO.	TUBE SIZE	PIPE THREAD	STRAIGHT THREAD	L	M	N	FLOW DIA. D
171C-2-2	1/8	1/8	5/16-24	.82	.61	.67	.094
171C-3-2	3/16	1/8	3/8-24	.86	.61	.67	.125
171C-4-2	1/4	1/8	7/16-24	.90	.64	.75	.188
171C-4-4	1/4	1/4	7/16-24	.93	.69	.92	.188
171C-6-4	3/8	1/4	9/16-24	1.09	.81	1.03	.312

Seal Plug 639C

PART NO.	TUBE SIZE	STRAIGHT THREAD	C HEX	L	M
639C-4	1/4	7/16-24	7/16	.74	.50

Male Branch Tee 172C

REF. SAE 060425 BA

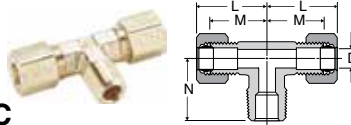

PART NO.	TUBE SIZE	PIPE THREAD	STRAIGHT THREAD	L	M	N	FLOW DIA. D
172C-2-2	1/8	1/8	5/16-24	.82	.61	.67	.094
172C-3-2	3/16	1/8	3/8-24	.86	.61	.67	.125
172C-4-2	1/4	1/8	7/16-24	.86	.61	.74	.188
172C-4-4	1/4	1/4	7/16-24	.93	.69	.92	.188
172C-6-2	3/8	1/8	9/16-24	1.03	.75	.75	.234
172C-6-4	3/8	1/4	9/16-24	1.09	.77	.92	.312
172C-6-6	3/8	3/8	9/16-24	1.09	.81	1.00	.312
172C-8-6	1/2	3/8	11/16-20	1.34	.93	1.10	.406

Straight Through Tank Fitting 682C

PART NO.	TUBE SIZE	PIPE THREAD	STRAIGHT THREAD	C HEX	L	M	FLOW DIA. D
682C-3-2	3/16	1/8	3/8-24	7/16	1.06	.84	.195
682C-6-6	3/8	3/8	9/16-24	11/16	1.44	1.16	.387
682C-8-8	1/2	1/2	11/16-20	7/8	1.90	1.31	.516

WARNING These products can expose you to chemicals including LEAD which is known to the state of California to cause cancer and birth defects or other reproductive harm. For more information go to www.P65Warnings.ca.gov.



Compress-Align® Fittings

Parker's Compress-Align Fittings are pre-assembled with a captive sleeve, always oriented for a faster installation. The design of the captive sleeve aligns to seal even out-of-round tubing.

Product Features:

- Self-aligning captive sleeve
- 2-piece fitting – Less inventory
- Visible inspection before and after installation
- 1/8" – 1" Sizes
- No flaring, soldering or other tube preparation
- Forged and extruded shapes

Markets:

- Industrial
- Packaging
- Pneumatic
- Printing
- Chemical

Applications:

- Air lines
- Lubrication Lines
- Cooling lines
- Industry
- Machinery
- Chemical Dispensing
- Compressors
- Fluid transfer

Compatible Tubing:

- Copper, Aluminum
- Thermoplastic tubing
- TFE, FEA, PFA

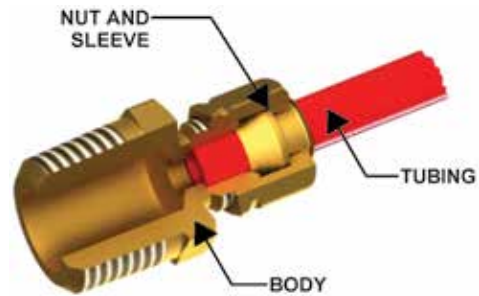

Assembly Instructions

With nut finger tight on fitting body, insert tubing until it bottoms in the Fitting. Complete the seal with one wrench turn for all sizes.



Specifications:

Temperature Range: -65° to +200° F (-53.8° to +93.3° C)

Pressure Range:

TUBE SIZE	PSI	bar	TUBE SIZE	PSI	bar
1/8	2800	193.0	1/2	750	51.7
3/16	1900	131.0	5/8	650	44.8
1/4	1400	96.5	3/4	550	37.9
5/16	1200	82.7	7/8	450	31.0
3/8	1000	68.9	1	350	24.1

WARNING These products can expose you to chemicals including LEAD which is known to the state of California to cause cancer and birth defects or other reproductive harm. For more information go to www.P65Warnings.ca.gov.



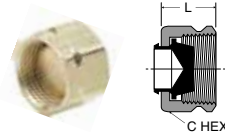

Plug 59CA

PART NO.	TUBE SIZE	STRAIGHT THREAD	C HEX	L
59CA-4	1/4	7/16-24	1/2	.40
59CA-6	3/8	9/16-24	5/8	.45
59CA-8	1/2	11/16-20	13/16	.50

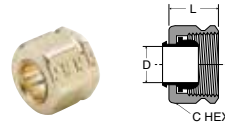

Nut and Sleeve Assembly 61CA

PART NO.	TUBE SIZE	STRAIGHT THREAD	C HEX	D	L
61CA-2	1/8	5/16-24	3/8	.130	.36
61CA-3	3/16	3/8-24	7/16	.194	.38
61CA-4	1/4	7/16-24	1/2	.255	.40
61CA-5	5/16	1/2-24	9/16	.318	.45
61CA-6	3/8	9/16-24	5/8	.382	.45
61CA-8	1/2	11/16-20	13/16	.507	.50
61CA-10	5/8	13/16-18	15/16	.632	.53
61CA-12	3/4	1-18	1-3/16	.760	.56
61CA-14	7/8	1-1/8-18	1-3/8	.885	.68
61CA-16	1	1-1/4-18	1-1/2	1.012	.63

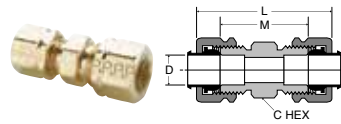

Union 62CA

PART NO.	SIZE	STRAIGHT THREAD	C HEX	L	M	FLOW DIA. D
62CA-2	1/8	5/16-24	5/16	1.12	.64	.094
62CA-3	3/16	3/8-24	3/8	1.19	.72	.125
62CA-4	1/4	7/16-24	7/16	1.26	.79	.188
62CA-5	5/16	1/2-24	1/2	1.32	.85	.250
62CA-6	3/8	9/16-24	9/16	1.42	.97	.312
62CA-8	1/2	11/16-20	11/16	1.53	1.08	.406
62CA-10	5/8	13/16-18	13/16	1.71	1.23	.500
62CA-12	3/4	1-18	1	2.20	1.41	.562
62CA-14	7/8	1-1/8-18	1-1/8	2.08	1.19	.766

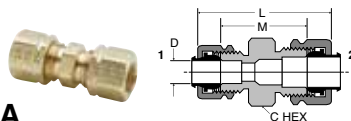

Union Reducers 62CA

PART NO.	1 TUBE SIZE	2 TUBE SIZE	1 STRAIGHT THREAD	2 STRAIGHT THREAD	C HEX	L	M	FLOW DIA. D
62CA-4-3	3/16	1/4	3/8-24	7/16-24	7/16	1.25	.78	.125
62CA-6-4	1/4	3/8	7/16-24	9/16-24	9/16	1.37	.91	.188
62CA-8-6	3/8	1/2	9/16-24	11/16-20	11/16	1.48	1.03	.312
62CA-10-6	3/8	5/8	9/16-24	13/16-18	13/16	1.59	1.13	.312

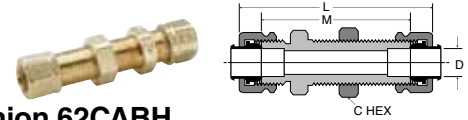

Bulkhead Union 62CABH

PART NO.	TUBE SIZE	STRAIGHT THREAD	C HEX	L	M	BULKHEAD HOLE DIA.	FLOW DIA. D
62CABH-4	1/4	7/16-24	9/16	2.22	1.75	7/16	.188
62CABH-6	3/8	9/16-24	11/16	2.32	1.88	9/16	.312

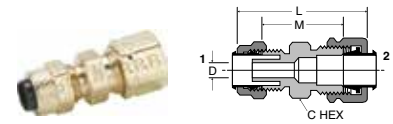

Union 62PCA

(Poly-Tite to Compress-Align)

PART NO.	TUBE SIZE	1 STRAIGHT THREAD	2 STRAIGHT THREAD	C HEX	L	M	FLOW DIA. D
62PCA-4	1/4	3/8-24	7/16-24	7/16	1.24	.89	.125
62PCA-5	5/16	7/16-24	1/2-24	1/2	1.26	.92	.144
62PCA-6	3/8	1/2-24	9/16-24	9/16	1.32	.98	.204

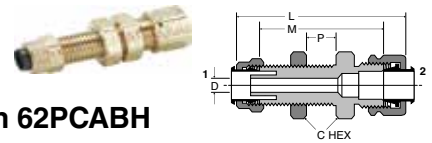

Bulkhead Union 62PCABH

(Poly-Tite to Compress-Align)

PART NO.	TUBE SIZE	1 STR THD	2 STR THD	C HEX	P MAX	L	M	FLOW BKHD DIA.	FLOW DIA. D
62PCABH-4	1/4	3/8-24	7/16-24	9/16	.38	1.80	1.45	3/8	.125
62PCABH-6	3/8	1/2-24	9/16-24	11/16	.47	1.98	1.64	1/2	.204



Brass Insert 63PT

PART NO.	TUBE SIZE	TUBE WALL	L	O.D.
63PT-2-16	1/8	.016	.46	.080
63PT-2-23	1/8	.023	.45	.073
63PT-3-25	3/16	.025	.45	.135
63PT-3-40	3/16	.040	.52	.095
63PT-4-40	1/4	.040	.50	.163
63PT-4-62	1/4	.062	.33	.110
63PT-5-40	5/16	.040	.50	.232
63PT-5-62	5/16	.062	.53	.187
63PT-8-62	3/8	.062	.56	.250
63PT-8-62	1/2	.062	.72	.370
63PT-10-62	5/8	.062	.72	.483

WARNING These products can expose you to chemicals including LEAD which is known to the state of California to cause cancer and birth defects or other reproductive harm. For more information go to www.P65Warnings.ca.gov.

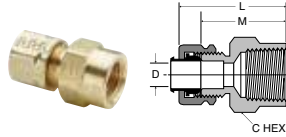

Female Connector 66CA

PART NO.	TUBE SIZE	PIPE THREAD	STRAIGHT THREAD	C HEX	L	M	FLOW DIA. D
66CA-2-2	1/8	1/8	5/16-24	9/16	.99	.75	.094
66CA-3-2	3/16	1/8	3/8-24	9/16	1.01	.78	.125
66CA-3-4	3/16	1/4	3/8-24	11/16	1.19	.96	.125
66CA-4-2	1/4	1/8	7/16-24	9/16	1.02	.78	.188
66CA-4-4	1/4	1/4	7/16-24	11/16	1.24	1.00	.188
66CA-5-2	5/16	1/8	1/2-24	9/16	1.05	.81	.250
66CA-5-4	5/16	1/4	1/2-24	11/16	1.27	1.03	.250
66CA-6-2	3/8	1/8	9/16-24	9/16	1.00	.78	.312
66CA-6-4	3/8	1/4	9/16-24	11/16	1.28	1.06	.312
66CA-6-6	3/8	3/8	9/16-24	13/16	1.29	1.06	.312
66CA-6-8	3/8	1/2	9/16-24	1	1.49	1.27	.312
66CA-8-4	1/2	1/4	11/16-20	11/16	1.32	1.09	.406
66CA-8-6	1/2	3/8	11/16-20	13/16	1.35	1.12	.406
66CA-8-8	1/2	1/2	11/16-20	1	1.54	1.31	.406
66CA-10-8	5/8	1/2	13/16-18	1	1.62	1.38	.500

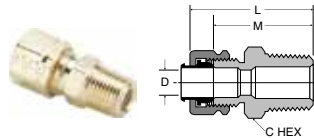

Male Connector 68CA

PART NO.	TUBE SIZE	PIPE THREAD	STRAIGHT THREAD	C HEX	L	M	FLOW DIA. D
68CA-2-1	1/8	1/16	5/16-24	3/8	1.02	.78	.095
68CA-2-2	1/8	1/8	5/16-24	7/16	1.01	.77	.094
68CA-3-1	3/16	1/16	3/8-24	3/8	1.07	.84	.125
68CA-3-2	3/16	1/8	3/8-24	7/16	1.07	.84	.125
68CA-3-4	3/16	1/4	3/8-24	9/16	1.26	1.03	.125
68CA-4-2	1/4	1/8	7/16-24	7/16	1.10	.86	.188
68CA-4-4	1/4	1/4	7/16-24	9/16	1.31	1.06	.188
68CA-4-6	1/4	3/8	7/16-24	11/16	1.28	1.03	.188
68CA-4-8	1/4	1/2	7/16-24	7/8	1.56	1.31	.188
68CA-5-2	5/16	1/8	1/2-24	1/2	1.13	.89	.234
68CA-5-4	5/16	1/4	1/2-24	9/16	1.35	1.07	.250
68CA-6-2	3/8	1/8	9/16-24	9/16	1.19	.97	.250
68CA-6-4	3/8	1/4	9/16-24	9/16	1.36	1.14	.312
68CA-6-6	3/8	3/8	9/16-24	11/16	1.43	1.16	.312
68CA-6-8	3/8	1/2	9/16-24	7/8	1.52	1.25	.312
68CA-8-4	1/2	1/4	11/16-20	11/16	1.45	1.22	.312
68CA-8-6	1/2	3/8	11/16-20	11/16	1.43	1.20	.406
68CA-8-8	1/2	1/2	11/16-20	7/8	1.54	1.31	.406
68CA-10-6	5/8	3/8	13/16-18	13/16	1.55	1.31	.406
68CA-10-8	5/8	1/2	13/16-18	7/8	1.72	1.48	.500
68CA-10-12	5/8	3/4	13/16-18	1-1/16	1.80	1.56	.500
68CA-12-8	3/4	1/2	1-18	1	1.99	1.60	.562
68CA-12-12	3/4	3/4	1-18	1-1/16	2.02	1.63	.656
68CA-14-12	7/8	3/4	1-1/8-18	1-1/8	1.85	1.41	.750
68CA-16-12	1	3/4	1-1/4-18	1-1/4	1.83	1.39	.750
68CA-16-16	1	1	1-1/4-18	1-3/8	2.02	1.58	.875

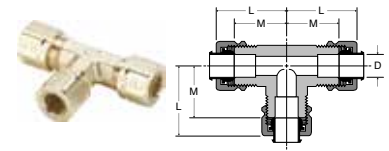

Union Tee 164CA-264CA

PART NO.	TUBE SIZE	STRAIGHT THREAD	L	M	FLOW DIA. D
164CA-2	1/8	5/16-24	.84	.61	.093
264CA-3	3/16	3/8-24	.83	.60	.125
164CA-4	1/4	7/16-24	.84	.63	.188
264CA-4	1/4	7/16-24	.84	.60	.188
164CA-5	5/16	1/2-24	.95	.71	.250
164CA-6	3/8	9/16-24	.96	.74	.312
164CA-8	1/2	11/16-20	1.15	.93	.406
164CA-10	5/8	13/16-18	1.32	1.08	.500
164CA-12	3/4	1.00-18	1.56	1.17	.562

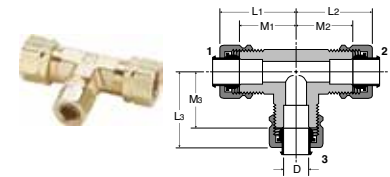

Union Tee 164CA combination sizes

PART NO.	1 TUBE SIZE	2 TUBE SIZE	3 TUBE SIZE	L1	L2	L3	M1	M2	M3	FLOW DIA. D
164CA-6-4-4	3/8	1/4	1/4	.97	.96	.96	.75	.72	.72	.188
164CA-6-6-4	3/8	3/8	1/4	.97	.97	.96	.75	.75	.72	.188
164CA-8-8-6	1/2	1/2	3/8	1.17	1.17	1.10	.94	.94	.88	.312

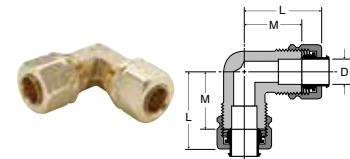

Union Elbow 165CA-265CA

PART NO.	TUBE SIZE	STRAIGHT THREAD	L	M	FLOW DIA. D
165CA-2	1/8	5/16-24	.84	.61	.094
165CA-3	3/16	3/8-24	.84	.61	.125
165CA-4	1/4	7/16-24	.84	.61	.188
265CA-4	1/4	7/16-24	.84	.60	.188
165CA-5	5/16	1/2-24	.94	.71	.250
165CA-6	3/8	9/16-24	.96	.74	.312
165CA-8	1/2	11/16-20	1.15	.93	.406
165CA-10	5/8	13/16-18	1.29	1.05	.500
165CA-12	3/4	1-18	1.56	1.17	.562
165CA-16	1	1-1/4-18	1.63	1.19	.877

WARNING These products can expose you to chemicals including LEAD which is known to the state of California to cause cancer and birth defects or other reproductive harm. For more information go to www.P65Warnings.ca.gov.

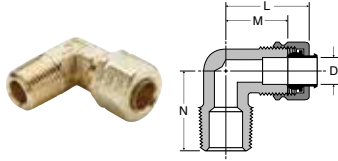

Male Elbow 169CA-269CA

PART NO.	TUBE SIZE	PIPE THREAD	STRAIGHT THREAD	L	M	N	FLOW DIA. D
169CA-2-1	1/8	1/16	5/16-24	.84	.60	.67	.095
269CA-2-2	1/8	1/8	5/16-24	.84	.60	.67	.094
169CA-3-1	3/16	1/16	3/8-24	.84	.61	.67	.126
169CA-3-2	3/16	1/8	3/8-24	.84	.61	.69	.125
269CA-3-2	3/16	1/8	3/8-24	.83	.60	.67	.125
169CA-3-4	3/16	1/4	3/8-24	.87	.64	.93	.125
169CA-4-2	1/4	1/8	7/16-24	.84	.61	.74	.188
269CA-4-2	1/4	1/8	7/16-24	.84	.60	.73	.188
169CA-4-4	1/4	1/4	7/16-24	.86	.62	.94	.188
269CA-4-4	1/4	1/4	7/16-24	.84	.60	.79	.188
169CA-4-6	1/4	3/8	7/16-24	.92	.68	1.00	.188
169CA-5-2 *	5/16	1/8	1/2-24	.84	.61	.74	.234
269CA-5-2 *	5/16	1/8	1/2-24	.84	.60	.73	.250
169CA-5-4	5/16	1/4	1/2-24	.94	.71	.93	.250
269CA-5-4	5/16	1/4	1/2-24	.91	.67	.82	.250
169CA-5-6	5/16	3/8	1/2-24	.99	.75	1.00	.250
169CA-6-2 *	3/8	1/8	9/16-24	.96	.74	.74	.234
269CA-6-2 *	3/8	1/8	9/16-24	.96	.69	.75	.220
169CA-6-4	3/8	1/4	9/16-24	.96	.74	.93	.312
269CA-6-4	3/8	1/4	9/16-24	.95	.73	.92	.312
169CA-6-6	3/8	3/8	9/16-24	.97	.75	1.00	.312
269CA-6-6	3/8	3/8	9/16-24	1.06	.84	.97	.312
169CA-6-8	3/8	1/2	9/16-24	1.16	.94	1.27	.312
169CA-8-4 *	1/2	1/4	11/16-20	1.17	.94	1.00	.312
169CA-8-6	1/2	3/8	11/16-20	1.15	.93	1.11	.406
169CA-8-8	1/2	1/2	11/16-20	1.23	1.00	1.37	.406
169CA-10-6 *	5/8	3/8	13/16-18	1.30	1.06	1.15	.406
169CA-10-8	5/8	1/2	13/16-18	1.30	1.06	1.31	.500
169CA-12-8	3/4	1/2	1-18	1.57	1.18	1.49	.562
169CA-12-12	3/4	3/4	1-18	1.66	1.27	1.58	.562
169CA-16-12 *	1	3/4	1-1/4-18	1.63	1.19	1.60	.875

* For these parts the pipe thread through hole is smaller than the through hole on the tube end.

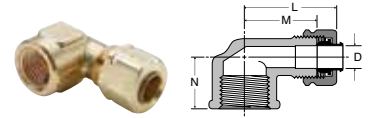

Female Elbow 170CA-270CA

PART NO.	TUBE SIZE	PIPE THREAD	STRAIGHT THREAD	L	M	N	FLOW DIA. D
170CA-2-2	1/8	1/8	5/16-24	.93	.69	.56	.094
170CA-3-2	3/16	1/8	3/8-24	.98	.69	.56	.125
170CA-4-2	1/4	1/8	7/16-24	.98	.69	.56	.188
270CA-4-2	1/4	1/8	7/16-24	.91	.67	.54	.188
170CA-4-4	1/4	1/4	7/16-24	1.02	.78	.67	.188
170CA-6-4	3/8	1/4	9/16-24	1.09	.79	.73	.312
170CA-6-6	3/8	3/8	9/16-24	1.16	.89	.69	.312
170CA-8-6	1/2	3/8	11/16-20	1.23	1.00	.69	.406
170CA-8-8	1/2	1/2	11/16-20	1.38	1.15	.97	.408
170CA-12-12	3/4	3/4	1-18	1.97	1.58	1.58	.563

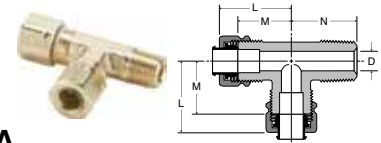

Male Run Tee 171CA

PART NO.	TUBE SIZE	PIPE THREAD	STRAIGHT THREAD	L	M	N	FLOW DIA. D
171CA-2-2	1/8	1/8	5/16-24	.84	.61	.67	.094
171CA-3-2	3/16	1/8	3/8-24	.83	.61	.67	.125
171CA-4-2	1/4	1/8	7/16-24	.88	.64	.75	.188
171CA-4-4	1/4	1/4	7/16-24	.93	.69	.92	.188
171CA-6-4	3/8	1/4	9/16-24	1.03	.81	1.03	.312

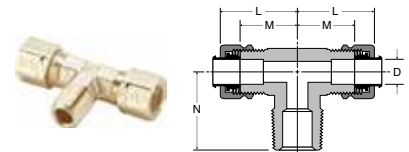

Male Branch Tee 172CA

PART NO.	TUBE SIZE	PIPE THREAD	STRAIGHT THREAD	L	M	N	FLOW DIA. D
172CA-2-2	1/8	1/8	5/16-24	.84	.61	.67	.093
172CA-3-2	3/16	1/8	3/8-24	.83	.61	.67	.125
172CA-4-2	1/4	1/8	7/16-24	.84	.61	.74	.188
172CA-4-4	1/4	1/4	7/16-24	.93	.69	.92	.188
172CA-6-2	3/8	1/8	9/16-24	.97	.75	.75	.234
172CA-6-4	3/8	1/4	9/16-24	.99	.77	.92	.312
172CA-6-6	3/8	3/8	9/16-24	1.07	.81	1.00	.312
172CA-8-6	1/2	3/8	11/16-20	1.15	.93	1.10	.406
172CA-12-12	3/4	3/4	1-18	1.67	1.27	1.50	.562

WARNING These products can expose you to chemicals including LEAD which is known to the state of California to cause cancer and birth defects or other reproductive harm. For more information go to www.P65Warnings.ca.gov.

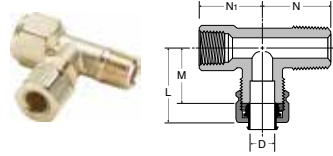

Adapter Tee 176CA

PART NO.	TUBE SIZE	PIPE THREAD	STRAIGHT THREAD	L	M	N	N1	FLOW DIA. D
176CA-4-2	1/4	1/8	7/16-24	.92	.69	.75	.66	.188

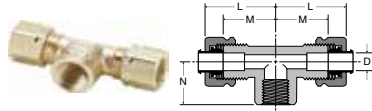

Female Branch Tee 177CA

PART NO.	TUBE SIZE	PIPE THREAD	STRAIGHT THREAD	L	M	N	FLOW DIA. D
177CA-4-2	1/4	1/8	7/16-24	.86	.63	.53	.188

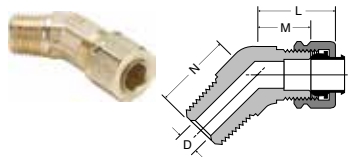

45° Elbow 179CA

PART NO.	TUBE SIZE	PIPE THREAD	STRAIGHT THREAD	L	M	N	FLOW DIA. D
179CA-4-2	1/4	1/8	7/16-24	.89	.66	.56	.188
179CA-4-4	1/4	1/4	7/16-24	.80	.56	.84	.188
179CA-6-2	3/8	1/8	9/16-24	.85	.63	.65	.234
179CA-6-4	3/8	1/4	9/16-24	.85	.63	.84	.312
179CA-6-6	3/8	3/8	9/16-24	.97	.75	.95	.312
179CA-8-6	1/2	3/8	11/16-20	1.03	.81	.95	.406

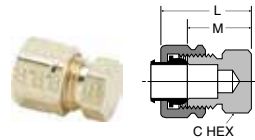

Seal Plug 639CA

PART NO.	TUBE SIZE	STRAIGHT THREAD	C HEX	L	M
639CA-4	1/4	7/16-24	7/16	.74	.50

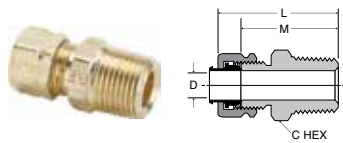

Straight Through Tank Fitting 682CA

PART NO.	TUBE SIZE	PIPE THREAD	STRAIGHT THREAD	C HEX	L	M	FLOW DIA. D
682CA-3-2	3/16	1/8	3/8-24	7/16	1.07	.84	.194

WARNING These products can expose you to chemicals including LEAD which is known to the state of California to cause cancer and birth defects or other reproductive harm. For more information go to www.P65Warnings.ca.gov.

Brass Metric Compression



Parker's Metric Compression Fittings provide users with an economical choice with numerous connection options for a wide variety of tube materials without the need for flaring, soldering or other tube preparation necessary to assemble.

Product Features:

- 4mm – 28mm tube sizes
- NPT, BSPT, BSPP, Metric Threads
- NBR seal
- Silicone free

Markets:

- Factory/Process Automation
- Automotive Process
- Packaging
- Pneumatic
- Printing

Applications:

- Air lines
- Lubrication Lines
- Cooling lines
- Water
- Machinery
- Compressors
- Fluid transfer

Compatible Tubing:

- Copper
- Aluminum
- Thermoplastic tubing

Specifications:

Temperature Range: -40° to +250° F (-40° to +121.1° C)

Pressure Range:

TUBE SIZE MM	PSI	bar	TUBE SIZE MM	PSI	bar
4	3335	229.9	14	652	44.9
6	2175	149.9	16	580	39.9
8	1450	99.9	18	536	36.9
10	1087	74.9	20	507	34.9
12	797	54.9	22	435	29.9

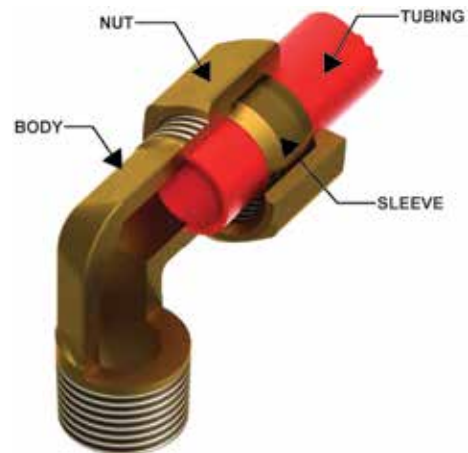

WARNING These products can expose you to chemicals including LEAD which is known to the state of California to cause cancer and birth defects or other reproductive harm. For more information go to www.P65Warnings.ca.gov.



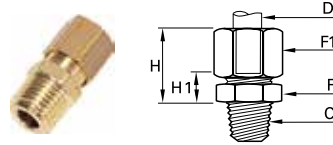

0105 Male Connector BSPT

PART NO.	OD	C	F	F1	H MAX	H1	KG
0105 04 10	4	R1/8	10	10	17	7	.012
0105 05 10	5	R1/8	11	12	17.5	7.5	.016
0105 05 13	5	R1/4	14	12	17.5	7.5	.022
0105 06 10	6	R1/8	11	13	18	7.5	.017
0105 06 13	6	R1/4	14	13	18	7.5	.024
0105 06 17	6	R3/8	17	13	18	8.5	.031
0105 08 10	8	R1/8	13	14	19.5	7	.020
0105 08 13	8	R1/4	14	14	19.5	7	.025
0105 08 17	8	R3/8	17	14	20.5	8	.032
0105 10 10	10	R1/8	17	19	24	9	.043
0105 10 13	10	R1/4	17	19	24	9	.047
0105 10 17	10	R3/8	17	19	24	9	.048
0105 10 21	10	R1/2	22	19	25	10	.067
0105 12 13	12	R1/4	19	22	24	9	.059
0105 12 17	12	R3/8	19	22	24	9	.060
0105 12 21	12	R1/2	22	22	25	10	.076
0105 14 13	14	R1/4	22	24	25	8	.068
0105 14 17	14	R3/8	22	24	25	8	.068
0105 14 21	14	R1/2	22	24	26	9	.080
0105 14 27	14	R3/4	27	24	27	10	.107
0105 15 17	15	R3/8	22	24	25	8	.065
0105 15 21	15	R1/2	22	24	26	9	.076
0105 16 13	16	R1/4	24	27	27	9.5	.092
0105 16 17	16	R3/8	24	27	27	9.5	.092
0105 16 21	16	R1/2	24	27	27	9.5	.099
0105 16 27	16	R3/4	27	27	28	10.5	.123
0105 18 21	18	R1/2	27	30	30	10.5	.127
0105 18 27	18	R3/4	27	30	30	10.5	.138
0105 20 21	20	R1/2	30	32	32	11	.148
0105 20 27	20	R3/4	30	32	32	11	.157
0105 22 21	22	R1/2	32	36	33	11	.187
0105 22 27	22	R3/4	32	36	33	11	.196
0105 22 34	22	R1	36	36	33	11	.227
0105 25 27	25	R3/4	36	41	36	11	.261
0105 25 34	25	R1	36	41	36	11	.278
0105 28 27	28	R3/4	41	42	36	11	.274
0105 28 34	28	R1	41	42	36	11	.283

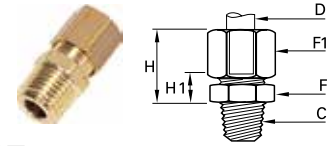

0105 Male Connector NPT

PART NO.	OD	C	F	F1	H MAX	H1	KG
0105 06 11	6	NPT1/8	11	13	18	7.5	.018
0105 06 14	6	NPT1/4	14	13	18	7.5	.027
0105 08 11	8	NPT1/8	13	14	21	7	.021
0105 08 14	8	NPT1/4	14	14	18.5	7	.026
0105 10 14	10	NPT1/4	17	19	24	9	.048
0105 10 18	10	NPT3/8	17	19	24	9	.048
0105 10 22	10	NPT1/2	22	19	25	10	.066

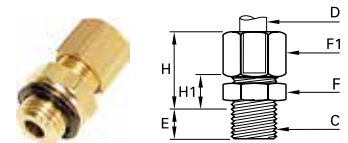

0101 Male Connector with Captive Sealing Washer Male BSPP

PART NO.	OD	C	E	F	F1	H MAX	H1	KG
0101 04 19	4	M5X0.8	5	10	10	16.5	8	.011
0101 04 10	4	G1/8	6.5	13	10	16.5	8	.016
0101 05 10	5	G1/8	6.5	13	12	17.5	8.5	.018
0101 06 10	6	G1/8	6.5	13	13	18	8.5	.020
0101 06 13	6	G1/4	8	17	13	18	9.5	.030
0101 08 10	8	G1/8	6.5	13	14	19	8.5	.021
0101 08 13	8	G1/4	8	17	14	19.5	9	.032
0101 08 17	8	G3/8	11	22	14	20	10.5	.044
0101 10 13	10	G1/4	8	17	19	24	11	.049
0101 10 17	10	G3/8	11	22	19	24	11.5	.061
0101 12 13	12	G1/4	8	19	22	24	11	.062
0101 12 17	12	G3/8	11	22	22	24	11.5	.069
0101 12 21	12	G1/2	12	27	22	24	12	.089
0101 14 17	14	G3/8	11	22	24	25	10.5	.074
0101 14 21	14	G1/2	12	27	24	25	11	.094
0101 15 17	15	G3/8	11	22	24	25	10.5	.071
0101 15 21	15	G1/2	12	27	24	25	11	.093
0101 16 17	16	G3/8	11	22	27	27	12	.092
0101 16 21	16	G1/2	12	27	27	27	12.5	.109
0101 18 21	18	G1/2	12	27	30	29.5	12.5	.128
0101 18 27	18	G3/4	13	32	30	29.5	13	.152
0101 20 27	20	G3/4	13	32	32	31	13	.164
0101 22 27	22	G3/4	13	32	36	32	13	.195
0101 22 34	22	G1	15	41	36	31	13.5	.259
0101 25 27	25	G3/4	13	36	41	35.5	13	.261
0101 25 34	25	G1	15	41	41	35.5	13	.169
0101 28 34	28	G1	15	41	42	35.5	13.5	.300

With pre-assembled captive polymer sealing washer

WARNING These products can expose you to chemicals including LEAD which is known to the state of California to cause cancer and birth defects or other reproductive harm. For more information go to www.P65Warnings.ca.gov.

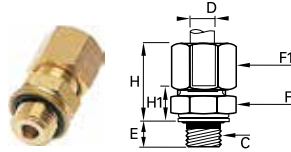

0101 Male Connector with Bi-Material Seal Male BSPP

PART NO.	OD	C	E	F	F1	H MAX	H1	KG
0101 04 10 39	4	G1/8	5.5	13	10	17.5	9	.016
0101 05 10 39	5	G1/8	5.5	13	12	18.5	9.5	.019
0101 06 10 39	6	G1/8	5.5	13	13	19	9.5	.020
0101 06 13 39	6	G1/4	7	17	13	19	10.5	.030
0101 08 10 39	8	G1/8	5.5	13	14	20	9.5	.022
0101 08 13 39	8	G1/4	7	17	14	20.5	10	.032
0101 08 17 39	8	G3/8	9.5	22	14	21.5	12	.045
0101 10 13 39	10	G1/4	7	17	19	25	12	.048
0101 10 17 39	10	G3/8	9.5	22	19	25.5	13	.062
0101 12 13 39	12	G1/4	7	19	22	25	12	.063
0101 12 17 39	12	G3/8	9.5	22	22	25	13	.071
0101 12 21 39	12	G1/2	10.5	27	22	25	13.5	.091
0101 14 17 39	14	G3/8	9.5	22	24	26.5	12	.075
0101 14 21 39	14	G1/2	10.5	27	24	26.5	12.5	.095
0101 15 17 39	15	G3/8	9.5	22	24	26.5	12	.073
0101 15 21 39	15	G1/2	10.5	27	24	26.5	12.5	.095
0101 16 17 39	16	G3/8	9.5	22	27	28.5	13.5	.092
0101 16 21 39	16	G1/2	10.5	27	27	28.5	14	.111
0101 18 21 39	18	G1/2	10.5	27	30	31	14	.129
0101 18 27 39	18	G3/4	11.5	32	30	31	14.5	.155
0101 20 27 39	20	G3/4	11.5	32	32	32.5	14.5	.164
0101 22 27 39	22	G3/4	11.5	32	36	32.5	14.5	.197
0101 22 34 39	22	G1	13	41	36	33	15.5	.259
0101 25 34 39	25	G1	13	41	41	37.5	15.5	.309
0101 28 34 39	28	G1	13	41	42	37.5	15.5	.301

Zinc plated steel with NBR seal

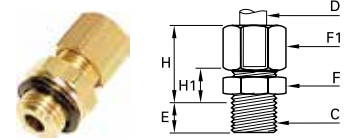

0101 Male Connector Metric Thread

PART NO.	OD	C	E	F	F1	H MAX	H1	KG
0101 04 55	4	M7X1	6.5	10	10	16.5	7.5	.012
0101 04 56	4	M8X1	6.5	11	10	16.5	7.5	.013
0101 05 56	5	M8X1	6.5	11	12	17.5	8	.016
0101 05 60	5	M10X1	6.5	14	12	17.5	8.5	.020
0101 06 60	6	M10X1	6.5	14	13	18	8.5	.021
0101 06 62	6	M10X1.5	6.5	14	13	18	8.5	.021
0101 08 65	8	M12X1	8	17	14	19.5	9	.029
0101 08 66	8	M12X1.25	8	17	14	19.5	9	.029
0101 08 68	8	M13X1.25	8	17	14	19.5	9	.030
0101 10 70	10	M14X1.25	8	17	19	24	11	.047
0101 10 71	10	M14X1.5	8	17	19	24	11	.047
0101 10 74	10	M16X1.25	9	19	19	24	11	.051
0101 10 75	10	M16X1.5	9	19	19	24	11	.051
0101 10 78	10	M18X1.5	9	22	19	24	11.5	.060
0101 12 74	12	M16X1.25	9	19	22	24	11	.061
0101 12 75	12	M16X1.5	9	19	22	24	11	.061
0101 12 78	12	M18X1.5	9	22	22	24	11.5	.070
0101 14 78	14	M18X1.5	9	22	24	25	10.5	.077
0101 14 80	14	M20X1.5	10	24	24	25	11	.084
0101 15 78	15	M18X1.5	9	22	24	25	10.5	.071
0101 16 80	16	M20X1.5	10	24	27	27	12.5	.102
0101 16 82	16	M22X1.5	10	27	27	27	12.5	.111
0101 18 82	18	M22X1.5	10	27	30	29.5	12.5	.129
0101 18 83	18	M24X1.5	11	30	30	29.5	13	.142

WARNING These products can expose you to chemicals including LEAD which is known to the state of California to cause cancer and birth defects or other reproductive harm. For more information go to www.P65Warnings.ca.gov.

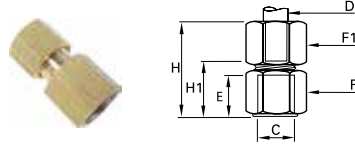

0114 Female Connector BSPP

PART NO.	OD	C	E	F	F1	H MAX	H1	KG
0114 04 10	4	G1/8	9.5	14	10	26	16.5	.020
0114 04 13	4	G1/4	13.5	17	10	30	20.5	.030
0114 05 10	5	G1/8	9.5	14	12	28	17	.023
0114 05 13	5	G1/4	13.5	17	12	31	21	.033
0114 06 10	6	G1/8	9.5	14	13	28	17	.025
0114 06 13	6	G1/4	13.5	17	13	32	21	.034
0114 06 17	6	G3/8	14	22	13	32	21.5	.051
0114 08 10	8	G1/8	9.5	14	14	29	16.5	.026
0114 08 13	8	G1/4	13.5	17	14	33	20.5	.036
0114 08 17	8	G3/8	14	22	14	34	21	.052
0114 10 13	10	G1/4	13.5	17	19	37	21.5	.052
0114 10 17	10	G3/8	14	22	19	37	22	.068
0114 10 21	10	G1/2	18.5	27	19	42	26.5	.099
0114 12 13	12	G1/4	13.5	19	22	36	20.5	.069
0114 12 17	12	G3/8	14	22	22	37	22	.078
0114 12 21	12	G1/2	18.5	27	22	42	26.5	.109
0114 14 13	14	G1/4	13.5	22	24	36	18.5	.085
0114 14 17	14	G3/8	14	22	24	38	21	.048
0114 14 21	14	G1/2	18.5	27	24	43	25.5	.113
0114 15 17	15	G3/8	14	22	24	38	21	.078
0114 15 21	15	G1/2	18.5	27	24	43	25.5	.109
0114 16 13	16	G1/4	13.5	24	27	36	18	.107
0114 16 17	16	G3/8	14	24	27	38	20.5	.106
0114 16 21	16	G1/2	18.5	27	27	44	26	.127
0114 18 17	18	G3/8	14	27	30	39	19.5	.140
0114 18 21	18	G1/2	18.5	27	30	45	26	.144
0114 18 27	18	G3/4	19.5	32	30	46	27	.165
0114 20 17	20	G3/8	14	30	32	38	18	.161
0114 20 21	20	G1/2	18.5	30	32	44.5	24	.173
0114 20 27	20	G3/4	19.5	32	32	47	26.5	.170
0114 22 27	22	G3/4	19.5	32	36	48	26.5	.204
0114 25 27	25	G3/4	19.5	36	41	50.5	26	.297

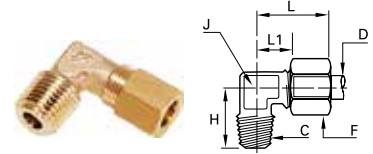

0109 Male Elbow BSPT

PART NO.	OD	C	F	H	J	L MAX	L1	KG
0109 04 10	4	R1/8	10	17	8	19	9.5	.016
0109 04 13	4	R1/4	10	20	10	19	11	.026
0109 05 10	5	R1/8	12	17.5	8	21	11	.019
0109 05 13	5	R1/4	12	21.5	10	22	12	.028
0109 06 10	6	R1/8	13	18	8	22	11	.021
0109 06 13	6	R1/4	13	21.5	10	22	12	.031
0109 08 10	8	R1/8	14	18.5	10	28	15	.028
0109 08 13	8	R1/4	14	22	10	28	15	.033
0109 08 17	8	R3/8	14	24	12	28	15	.044
0109 10 13	10	R1/4	19	25	12	30	14.5	.052
0109 10 17	10	R3/8	19	25.5	12	30	14.5	.060
0109 10 21	10	R1/2	19	32	19	36	21	.109
0109 12 13	12	R1/4	22	26	15	30	15	.074
0109 12 17	12	R3/8	22	27	15	30	15	.077
0109 12 21	12	R1/2	22	32	19	36	21	.116
0109 14 17	14	R3/8	24	30	19	35	18	.105
0109 14 21	14	R1/2	24	32	19	35	18	.112
0109 15 17	15	R3/8	24	30	19	35	18	.099
0109 15 21	15	R1/2	24	32	19	35	18	.106
0109 16 17	16	R3/8	27	30	19	39	21	.120
0109 16 21	16	R1/2	27	33.5	19	39	21	.130
0109 16 27	16	R3/4	27	36.5	23	41	23	.189
0109 18 21	18	R1/2	30	35.5	23	41	21.5	.182
0109 18 27	18	R3/4	30	36.5	23	41	21.5	.199
0109 20 21	20	R1/2	32	36.5	23	42	21.5	.181
0109 20 27	20	R3/4	32	38	23	42	21.5	.200
0109 22 27	22	R3/4	36	40	27	50	30	.288
0109 22 34	22	R1	36	44	27	50	30	.342
0109 25 27	25	R3/4	41	43	27	54	30	.325
0109 25 34	25	R1	41	44	27	54	30	.367
0109 28 27	28	R3/4	42	46	32	54	30	.402
0109 28 34	28	R1	42	48	32	54	30	.384

WARNING These products can expose you to chemicals including LEAD which is known to the state of California to cause cancer and birth defects or other reproductive harm. For more information go to www.P65Warnings.ca.gov.

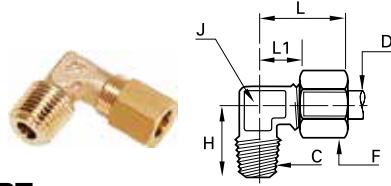

0109 Male Elbow NPT

PART NO.	OD	C	F	H	J	L MAX	L1	KG
0109 06 11	6	1/8	13	18	8	22	11	.021
0109 06 14	6	1/4	13	21.5	10	22	12	.030
0109 08 11	8	1/8	14	18.5	10	28	15	.028
0109 08 14	8	1/4	14	22	10	28	15	.033
0109 10 14	10	1/4	19	25	12	30	14.5	.053

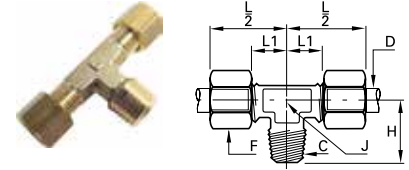

0108 Male Branch Tee Male BSPT

PART NO.	OD	C	F	H	J	L1	L2	KG
0108 04 10	4	R1/8	10	17	8	9.5	19	.025
0108 05 10	5	R1/8	12	17.5	8	11	21	.017
0108 06 10	6	R1/8	13	18	8	11	22	.032
0108 06 13	6	R1/4	13	21.5	10	16	27	.047
0108 08 10	8	R1/8	14	18.5	10	15	28	.045
0108 08 13	8	R1/4	14	22	10	15	28	.050
0108 08 17	8	R3/8	14	24	12	15	28	.061
0108 10 13	10	R1/4	19	25	12	14.5	30	.084
0108 10 17	10	R3/8	19	25.5	12	14.5	30	.090
0108 12 13	12	R1/4	22	26	15	15	30	.116
0108 12 17	12	R3/8	22	27	15	15	30	.117
0108 14 17	14	R3/8	24	30	19	18	35	.153
0108 14 21	14	R1/2	24	32	19	18	35	.168
0108 15 17	15	R3/8	24	30	19	18	35	.145
0108 15 21	15	R1/2	24	32	19	18	35	.155
0108 16 17	16	R3/8	27	30	19	21	39	.190
0108 16 21	16	R1/2	27	33.5	19	21	39	.203
0108 18 21	18	R1/2	30	35.5	23	21.5	41	.265
0108 18 27	18	R3/4	30	36.5	23	21.5	41	.292
0108 20 27	20	R3/4	32	38	23	21.5	42	.298
0108 22 27	22	R3/4	36	40	27	29	50	.435
0108 22 34	22	R1	36	44	27	29	50	.466

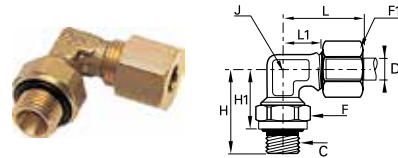

0199 Adjustable Male Elbow BSPP

PART NO.	OD	C	F	F1	H	H1	H1 MAX	J	L MAX	L1	KG
0199 04 10	4	G1/8	14	10	23	16	17	8	19	9.5	.023
0199 04 13	4	G1/4	19	10	30.5	22	23.5	10	19	11	.043
0199 06 10	6	G1/8	14	13	23	16	17	8	22	11	.027
0199 06 13	6	G1/4	19	13	30.5	22	23.5	10	22	12	.047
0199 08 10	8	G1/8	14	14	24	17	18	10	28	15	.033
0199 08 13	8	G1/4	19	14	30.5	22	23.5	10	28	15	.051
0199 08 17	8	G3/8	22	14	33.5	24	25.5	12	28	15	.065
0199 10 13	10	G1/4	19	19	31	22.5	24	12	30	14.5	.068
0199 10 17	10	G3/8	22	19	33.5	24	25.5	12	30	14.5	.079
0199 10 21	10	G1/2	27	19	40	29.5	31	19	37	22	.138
0199 14 17	14	G3/8	22	24	35.5	26	27.5	19	35	18	.119
0199 14 21	14	G1/2	27	24	40	29.5	31	19	35	18	.141
0199 18 21	18	G1/2	27	30	40	29	30.5	23	41	21.5	.187
0199 18 27	18	G3/4	32	30	43.5	32	33.5	23	41	21.5	.222
0199 22 27	22	G3/4	32	36	45.5	34	36	32	51	31	.382
0199 22 34	22	G1	41	36	54	40.5	43	32	51	31	.408
0199 28 34	28	G1	41	42	54	40.5	43	32	54	30	.420

The body will orientate for positioning purposes

WARNING These products can expose you to chemicals including LEAD which is known to the state of California to cause cancer and birth defects or other reproductive harm. For more information go to www.P65Warnings.ca.gov.

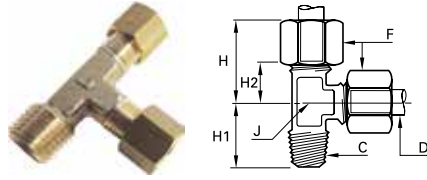

0103 Male Run Tee BSPT

PART NO.	OD	C	F	H MAX	H1	H2	J	KG
0103 04 10	4	R1/8	10	19	17	9.5	8	.025
0103 05 10	5	R1/8	12	21	17.5	11	8	.030
0103 06 10	6	R1/8	13	22	18	11	8	.033
0103 06 13	6	R1/4	13	27	21.5	16	10	.048
0103 08 10	8	R1/8	14	28	18.5	15	10	.045
0103 08 13	8	R1/4	14	28	22	15	10	.050
0103 08 17	8	R3/8	14	28	24	15	12	.061
0103 10 13	10	R1/4	19	30	25	14.5	12	.084
0103 12 13	12	R1/4	22	30	26	15	15	.114
0103 12 17	12	R3/8	22	30	27	15	15	.120
0103 14 17	14	R3/8	24	35	30	18	19	.161
0103 14 21	14	R1/2	24	35	32	18	19	.169
0103 15 17	15	R3/8	24	35	30	18	19	.148
0103 15 21	15	R1/2	24	35	32	18	19	.158
0103 16 17	16	R3/8	27	39	30	21	19	.192
0103 16 21	16	R1/2	27	39	33.5	21	19	.199
0103 18 21	18	R1/2	30	41	35.5	21.5	23	.269
0103 18 27	18	R3/4	30	41	36.5	21.5	23	.282
0103 20 27	20	R3/4	32	42	38	21.5	23	.298
0103 22 27	22	R3/4	36	50	40	29	27	.435
0108 22 34	22	R1	36	44	27	29	50	.466

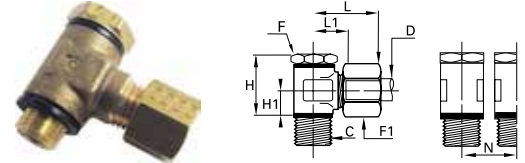

0118 Single Banjo with Captive Sealing Washer Male BSPP

PART NO.	OD	C	F	F1	H	H1	L1 MAX	L1	N	KG
0118 04 10	4	G1/8	14	10	24	9.5	24	14.5	17.5	.038
0118 05 10	5	G1/8	14	12	24	9.5	25	14.5	17.5	.041
0118 05 13	5	G1/4	17	12	25	10	26	16	21	.058
0118 06 10	6	G1/8	14	13	24	9.5	25	14.5	17.5	.041
0118 06 13	6	G1/4	17	13	25	10	26	16	21	.056
0118 08 10	8	G1/8	14	14	24	9.5	28	15.5	17.5	.054
0118 08 13	8	G1/4	17	14	25	10	28	15.5	21	.057
0118 08 17	8	G3/8	22	14	32	13	30	18	26.5	.111
0118 10 13	10	G1/4	17	19	31	13	34	19	23	.120
0118 10 17	10	G3/8	22	19	32	13	34	19	26.5	.129
0118 12 13	12	G1/4	17	22	34	14.5	34	19	23	.126
0118 12 17	12	G3/8	22	22	35	14.5	34	19	26.5	.133
0118 14 13	14	G1/4	17	24	37	16	37	20.5	28	.154
0118 14 17	14	G3/8	22	24	38	16	37	20.5	28	.195
0118 14 21	14	G1/2	27	24	40	16	38	20.5	32.5	.208
0118 15 17	15	G3/8	22	24	38	16	37	20.5	28	.190
0118 15 21	15	G1/2	27	24	40	16	38	20.5	32.5	.198
0118 16 21	16	G1/2	27	27	42	16	38	21	32.5	.221
0118 18 21	18	G1/2	27	30	46	19.5	43	24.5	36	.366
0118 20 27	20	G3/4	32	32	49	20	44	24.5	39	.403
0118 22 27	22	G3/4	32	36	53	22	45	24.5	39	.459

With pre-assembled captive polymer sealing washer

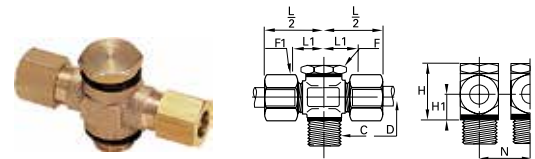

0119 Double Banjo with Captive Sealing Washer Male BSPP

PART NO.	OD	C	F	F1	H	H1	L1	L2	N	KG
0119 04 10	4	G1/8	14	10	24	9.5	14.5	24	17.5	.049
0119 06 10	6	G1/8	14	13	24	9.5	14.5	25	17.5	.056
0119 06 13	6	G1/4	17	13	25	10	16	26.5	21	.038
0119 08 10	8	G1/8	14	14	24	9.5	15.5	28	17.5	.069
0119 08 13	8	G1/4	17	14	25	10	15.5	28	21	.074
0119 08 17	8	G3/8	22	14	32	13	18	30.5	26.5	.140
0119 10 13	10	G1/4	17	19	31	13	19	34	23	.156
0119 10 17	10	G3/8	22	19	32	13	19	34	26.5	.165
0119 12 13	12	G1/4	17	22	34	14.5	19	34	23	.180
0119 12 17	12	G3/8	22	22	35	14.5	19	34	26.5	.182
0119 14 13	14	G1/4	17	24	37	16	20.5	37.5	28	.246
0119 14 17	14	G3/8	22	24	38	16	20.5	37.5	28	.247
0119 14 21	14	G1/2	27	24	40	16	20.5	38	32.5	.219

Zinc plated steel with NBR seal. Thread with pre-assembled polymer washer

WARNING These products can expose you to chemicals including LEAD which is known to the state of California to cause cancer and birth defects or other reproductive harm. For more information go to www.P65Warnings.ca.gov.

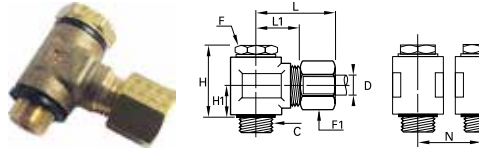

0118 Single Banjo with Bi-Material Seal Male BSPP

PART NO.	OD	C	F	F1	H	H1	L1 MAX	L1	N	KG
0118 04 10 39	4	G1/8	14	10	23	9.5	24	14.5	17.5	.038
0118 05 10 39	5	G1/8	14	12	23	9.5	25	14.5	17.5	.041
0118 05 13 39	5	G1/4	17	12	24	10	26	16	21	.064
0118 06 10 39	6	G1/8	14	13	23	9.5	25	14.5	17.5	.042
0118 06 13 39	6	G1/4	17	13	24	10	26	16	21	.057
0118 08 10 39	8	G1/8	14	14	23	9.5	28	15.5	17.5	.055
0118 08 13 39	8	G1/4	17	14	24	10	28	15.5	21	.058
0118 08 17 39	8	G3/8	22	14	31.5	13.5	30	18	26.5	.113
0118 10 13 39	10	G1/4	17	19	30	13	34	19	23	.118
0118 10 17 39	10	G3/8	22	19	31.5	13.5	34	19	26.5	.128
0118 12 13 39	12	G1/4	17	22	33	14.5	34	19	23	.128
0118 12 17 39	12	G3/8	22	22	34.5	15	34	19	26.5	.140
0118 14 13 39	14	G1/4	17	24	36	16	37	20.5	28	.189
0118 14 17 39	14	G3/8	22	24	37.5	16.5	37	20.5	28	.198
0118 14 21 39	14	G1/2	27	24	39	16.5	38	20.5	32.5	.205
0118 15 17 39	15	G3/8	22	24	37.5	16.5	37	20.5	28	.389
0118 15 21 39	15	G1/2	27	24	40	16.5	38	20.5	32.5	.202
0118 16 21 39	16	G1/2	27	27	40	16.5	38	21	32.5	.225
0118 18 21 39	18	G1/2	27	30	47	20	43	24.5	36	.369
0118 20 27 39	20	G3/4	32	32	50	20.5	44	24.5	39	.394
0118 22 27 39	22	G3/4	32	36	54	22.5	45	24.5	39	.462

Zinc plated steel with NBR seal

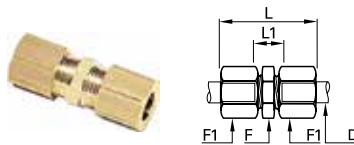

0106 Equal Tube-to-Tube Connector

PART NO.	OD	F	F1	L MAX	L1	KG
0106 04 00	4	10	10	28	10	.016
0106 05 00	5	11	12	31	11	.023
0106 06 00	6	11	13	32	11	.026
0106 08 00	8	13	14	36	10	.031
0106 10 00	10	17	19	42	13	.070
0106 12 00	12	19	22	42	13	.092
0106 14 00	14	22	24	45	11	.104
0106 15 00	15	22	24	45	11	.097
0106 16 00	16	24	27	48	13	.141
0106 18 00	18	27	30	53	14	.186
0106 20 00	20	30	32	56	14	.211
0106 22 00	22	32	36	60	14	.283
0106 25 00	25	36	41	64	14	.396
0106 28 00	28	41	42	64	14	.399

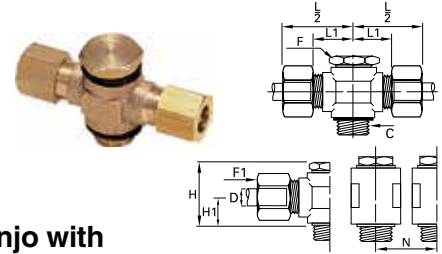

0119 Double Banjo with Bi-Material Seal Male BSPP

PART NO.	OD	C	F	F1	H	H1	L1	L2	N	KG
0119 04 10 39	4	G1/8	14	10	23	9.5	14.5	24	17.5	.050
0119 05 10 39	5	G1/8	14	12	23	9.5	14.5	25	17.5	.049
0119 05 13 39	5	G1/4	17	12	24	10	126	26	21	.072
0119 06 10 39	6	G1/8	14	13	23	9.5	14.5	25	17.5	.056
0119 06 13 39	6	G1/4	17	13	24	10	16	26	21	.071
0119 08 10 39	8	G1/8	14	14	23	9.5	15.5	28	17.5	.072
0119 08 13 39	8	G1/4	17	14	24	10	15.5	28	21	.080
0119 08 17 39	8	G3/8	22	14	31.5	13.5	18	30	26.5	.118
0119 10 13 39	10	G1/4	17	19	30	13	19	34	23	.156
0119 10 17 39	10	G3/8	22	19	31.5	13.5	19	34	26.5	.167
0119 12 13 39	12	G1/4	17	22	33	14.5	19	34	23	.180
0119 12 17 39	12	G3/8	22	22	34.5	15	19	34	26.5	.183
0119 14 13 39	14	G1/4	17	24	36	16	20.5	37	28	.248
0119 14 17 39	14	G3/8	22	24	37.5	16.5	20.5	37	28	.247
0119 14 21 39	14	G1/2	27	24	39	16.5	20.5	38	32.5	.262
0119 15 17 39	15	G3/8	22	24	37.5	16.5	20.5	37	28	.246
0119 15 21 39	15	G1/2	27	24	40	16.5	20.5	38	32.5	.251
0119 18 21 39	18	G1/2	27	30	47	20	24.5	43	36	.469
0119 20 27 39	20	G3/4	32	32	50	20.5	24.5	44	39	.638
0119 22 27 39	22	G3/4	32	36	54	22.5	24.5	45	39	.610

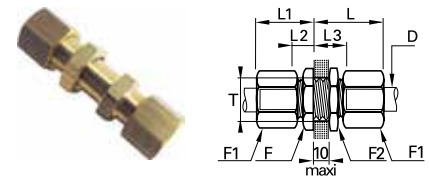

0116 Bulkhead Union

PART NO.	OD	F	F1	F2	L MAX	L1 MAX	L2	L3	OT MIN	KG
0116 04 00	4	10	10	13	27	17	7	17	8.3	.024
0116 05 00	5	13	12	14	28	18	7.5	17.5	10.3	.035
0116 06 00	6	13	13	14	28	19	7.5	17.5	10.3	.037
0116 08 00	8	14	14	17	29	20	7	17	12.3	.045
0116 10 00	10	19	19	22	33	25	9	19	16.5	.101
0116 12 00	12	22	22	22	33	25	9	19	18.5	.121
0116 14 00	14	24	24	24	35	25	8	18	20.5	.145
0116 15 00	15	24	24	24	35	25	8	18	20.5	.134
0116 16 00	16	27	27	27	36	28	9.5	19.5	22.5	.189
0116 18 00	18	27	30	30	40	30	10.5	20.5	24.5	.237
0116 20 00	20	32	30	32	41	31	11	21	27.5	.274
0116 22 00	22	36	36	36	42	32	11	21	30.5	.372
0116 25 00	25	36	41	38	46	36	11	21	33.5	.469

WARNING These products can expose you to chemicals including LEAD which is known to the state of California to cause cancer and birth defects or other reproductive harm. For more information go to www.P65Warnings.ca.gov.

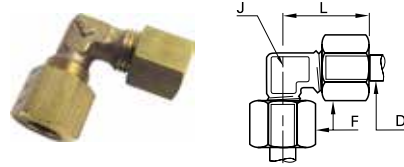

0102 Union Elbow

PART NO.	OD	F	J	L MAX	KG
0102 04 00	4	10	5	19	.016
0102 05 00	5	12	8	21	.024
0102 06 00	6	13	8	22	.027
0102 08 00	8	14	10	28	.038
0102 10 00	10	19	12	30	.073
0102 12 00	12	22	15	30	.098
0102 14 00	14	24	19	35	.133
0102 15 00	15	24	19	35	.122
0102 16 00	16	27	19	39	.164
0102 18 00	18	30	23	41	.231
0102 20 00	20	32	23	42	.233
0102 22 00	22	36	27	50	.371
0102 25 00	25	41	27	54	.446
0102 28 00	28	42	32	54.5	.478

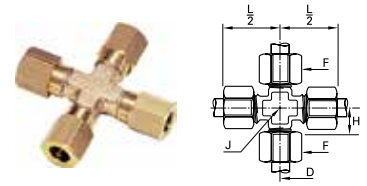

0107 Union Cross

PART NO.	OD	F	H	J	L2	KG
0107 04 00	4	10	9.5	8	19	.035
0107 05 00	5	12	11	8	21	.047
0107 06 00	6	13	11	8	22	.052
0107 08 00	8	14	15	11	28	.073
0107 10 00	10	19	14.5	14	30	.142
0107 12 00	12	22	15	15	35	.096
0107 14 00	14	24	18	20	35	.246
0107 15 00	15	24	18	20	35	.227
0107 16 00	16	27	21	20	39	.312
0107 18 00	18	30	21.5	25	41	.426
0107 20 00	20	32	21.5	25	42	.429
0107 22 00	22	36	29	27	50	.676
0107 25 00	25	41	29	27	50	.819

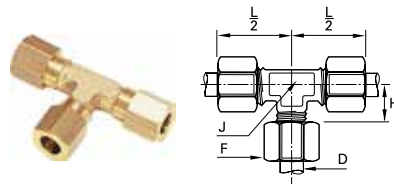

0104 Union Tee

PART NO.	OD	F	H	J	L 2	KG
0104 04 00	4	10	9.5	8	19	.028
0104 05 00	5	12	11	8	21	.036
0104 06 00	6	13	11	8	22	.040
0104 08 00	8	14	15	10	28	.055
0104 10 00	10	19	14.5	12	30	.105
0104 12 00	12	22	15	15	30	.142
0104 14 00	14	24	18	19	35	.190
0104 15 00	15	24	18	19	35	.175
0104 16 00	16	27	21	19	39	.239
0104 18 00	18	30	21.5	23	41	.330
0104 20 00	20	32	21.5	23	42	.330
0104 22 00	22	36	29	27	50	.518
0104 25 00	25	41	29	27	54	.630
0104 28 00	28	42	30	32	55	.660

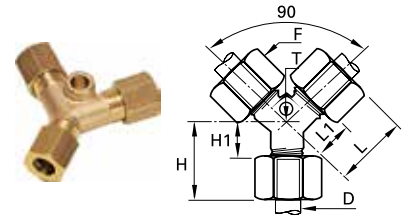

0142 Union Y with Mounting Boss

PART NO.	OD	F	H MAX	H1	L MAX	L1	ØT	KG
0142 04 00	4	10	16.5	7	26.5	17	4.2	.032
0142 06 00	6	13	19.5	8.5	28	17	4.2	.049
0142 08 00	8	14	21	8	30	17	6.2	.061
0142 10 00	10	19	24.5	9	37.5	22	6.2	.128
0142 12 00	12	22	26	11	38	23	6.2	.110
0142 14 00	14	24	28	11	41.5	24.5	6.2	.201
0142 15 00	15	24	28	11	41.5	24.5	6.2	.204
0142 16 00	16	27	30	12	43	25	6.2	.252
0142 18 00	18	30	31.5	12	50.5	31	10.2	.220
0142 25 00	25	41	39	14	59	34	10.2	.728

WARNING These products can expose you to chemicals including LEAD which is known to the state of California to cause cancer and birth defects or other reproductive harm. For more information go to www.P65Warnings.ca.gov.



0124 Suffix 40, 0111 Sleeves

OD MM	PART NO.	WT	PART NO.	WT	PART NO.	WT
4	0124 04 00	.001	0124 04 40	.001	0111 04 00	.001
5	0124 05 00	.001	0124 05 40	.001	0111 05 00	.001
6	0124 06 00	.001	0124 06 40	.001	0111 06 00	.001
8	0124 08 00	.002	0124 08 40	.002	0111 08 00	.002
10	0124 10 00	.003	0124 10 40	.003	0111 10 00	.002
12	0124 12 00	.004	0124 12 40	.004	0111 12 00	.003
14	0124 14 00	.004	0124 14 40	.005	0111 14 00	.003
15	0124 15 00	.004	0124 15 40	.005	0111 15 00	.003
16	0124 16 00	.006	0124 16 40	.006	0111 16 00	.004
18	0124 18 00	.007	0124 18 40	.008	-	-
20	0124 20 00	.009	0124 20 40	.008	-	-
22	0124 22 00	.012	0124 22 40	.010	-	-
25	0124 25 00	.017	0124 25 40	.015	-	-
28	0124 28 00	.017	-	-	-	-

Technical Specifications of Nuts

Tightening Torque

- Maximum kg = tightening torque for nut 0110 and sleeve 0124 on copper, brass or steel tube

OD MM	MAX KG. TORQUE
4	.7
5	.7
6	1.5
8	1.5
10	1.8
12	3
14	3.5
15	4
16	5
18	6
20	6
22	7
25	8
28	9

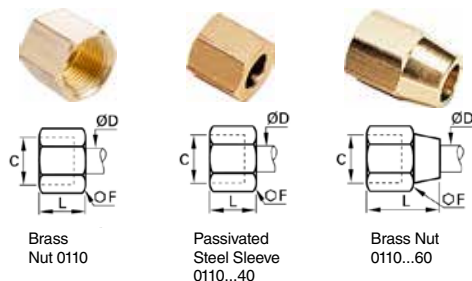

0110, 0110 Suffix 40, 0110 Suffix 60 Nuts

OD MM	C	PART NO.	WT	PART NO.	WT	PART NO.	WT
4	M8X1	0110 04 00	.005	0110 04 00 40	.004	0110 04 00 60	.006
5	M10X1	0110 05 00	.006	0110 05 00 40	.006	0110 05 00 60	.009
6	M10X1	0110 06 00	.008	0110 06 00 40	.008	0110 06 00 60	.011
8	M12X1	0110 08 00	.008	0110 08 00 40	.009	0110 08 00 60	.012
10	M16X1.5	0110 10 00	.019	0110 10 00 40	.019	0110 10 00 60	.027
12	M18X1.5	0110 12 00	.026	0110 12 00 40	.027	0110 12 00 60	.041
14	M20X1.5	0110 14 00	.029	-	-	-	-
15	M20X1.5	0110 15 00	.028	0110 15 00 40	.030	0110 15 00 60	.050
16	M22X1.5	0110 16 00	.043	0110 16 00 40	.043	0110 16 00 60	.072
18	M24X1.5	0110 18 00	.059	0110 18 00 40	.057	-	-
20	M27X1.5	0110 20 00	.057	-	-	-	-
22	M30X1.5	0110 22 00	.079	0110 22 00 40	.084	-	-
25	M33X1.5	0110 25 00	.121	-	-	-	-
28	M36X1.5	0110 28 00	.109	-	-	-	-

WARNING These products can expose you to chemicals including LEAD which is known to the state of California to cause cancer and birth defects or other reproductive harm. For more information go to www.P65Warnings.ca.gov.

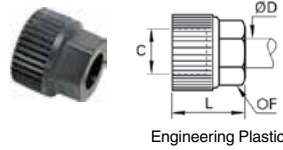

0110 Suffix 70 Nut Sleeve

ØD MM	C	PART NO.	F MM	L MM	WT
4	M8X1	0110 04 00 70	8	13	.001
6	M10X1	0110 06 00 70	11	15	.002
8	M12X1	0110 08 00 70	13	16	.002
10	M16X1.5	0110 10 00 70	17	19	.004
12	M18X1.5	0110 12 00 70	19	19	.005
14	M20X1.5	0110 14 00 70	22	20	.007
16	M22X1.5	0110 16 00 70	24	21	.009

Plastic nut-sleeve should not be used on metal tubes.

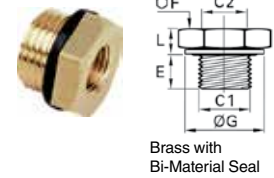

0168 Reducer Male To Female BSPP

C1 BSPP	C2 BSPP	PART NO.	E MM	F MM	G MM	L MM	WT
G 1/8	M5X.8	0168 10 19 39	8	14	14	4.5	.010
G 1/4	M5X.8	0168 13 19 39	8	17	17	5	.012
G 1/4	G 1/8	0168 13 10 39	8	17	17	5	.020
G 3/8	G 1/8	0168 17 10 39	10	19	22	5	.028
G 3/8	G 1/4	0168 17 13 39	10	19	22	5	.035
G 1/2	G 1/8	0168 21 10 39	12	24	26	7.5	.039
G 1/2	G 1/4	0168 21 13 39	12	24	26	7.5	.056
G 1/2	G 3/8	0168 21 17 39	12	24	26	7.5	.062
G 3/4	G 1/4	0168 27 13 39	12	32	32	9.5	.067
G 3/4	G 3/8	0168 27 17 39	12	32	32	9.5	.097
G 3/4	G 1/2	0168 27 21 39	12	32	32	9.5	.116

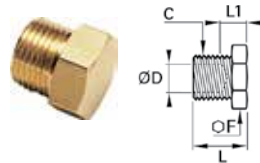

0125 End Plug Metric

ØD MM	C	PART NO.	F MM	L MM	L1 MM	WT
4	M8X1	0125 04 00	10	12	8	.006
6	M10X1	0125 06 00	11	13.5	9.5	.009
8	M12X1	0125 08 00	14	14	9	.012
10	M16X1.5	0125 10 00	17	18	11	.025
12	M18X1.5	0125 12 00	19	18	11	.031
14	M20X1.5	0125 14 00	22	19	11	.039

The plug enables unused tubes to be blanked off. The male thread on the plug has the same pitch as the female thread on the nut of a standard Legris fitting. Therefore, the plug screwed into the nut blanks off the tube.

To reopen the passage, simply unscrew the plug and fit the required connector. No further treatment of the tube is required.

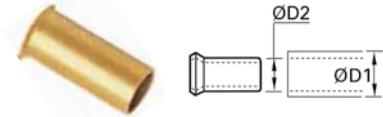

0127 Tube Support for Plastic Tube

ØD1 MM	ØD2 MM	PART NO.	WT
4	2	0127 04 00	.001
4	2.7	0127 04 27	.001
5	3	0127 05 03	.001
5	3.3	0127 05 00	.001
6	4	0127 06 00	.001
8	5.5	0127 08 55	.001
8	6	0127 08 00	.001
10	7	0127 10 07	.002
10	7.5	0127 10 75	.002
10	8	0127 10 00	.002
12	8	0127 12 08	.002
12	9	0127 12 09	.002
12	10	0127 12 00	.002
14	11	0127 14 11	.003
14	12	0127 14 00	.003
15	12	0127 15 12	.003
16	13	0127 16 13	.003
18	14	0127 18 14	.004
20	15	0127 20 15	.004
22	16	0127 22 16	.005
25	19	0127 25 19	.005

At high temperature and pressure or during oscillating movements, the use of tube supports prevents distortion of the tube and guarantees effective gripping and sealing.

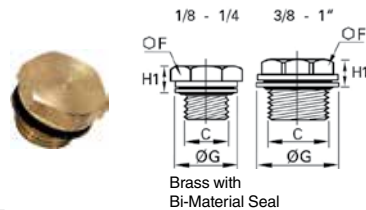

0220 Male Plug BSPP

C BSPP	PART NUMBER	F MM	G MM	H1 MM	WT
G 1/8	0220 10 00 39	14	14	6.5	.005
G 1/4	0220 13 00 39	17	17	6.5	.016
G 3/8	0220 17 00 39	17	22	8	.021
G 1/2	0220 21 00 39	22	26	9	.045
G 3/4	0220 27 00 39	22	32	10	.053
G 1	0220 34 00 39	27	39.5	10.5	.067

WARNING These products can expose you to chemicals including LEAD which is known to the state of California to cause cancer and birth defects or other reproductive harm. For more information go to www.P65Warnings.ca.gov.

Poly-Tite Fittings



Parker's Poly-Tite Fittings are compact, pre-assembled compression style fittings designed for fast assembly. An exclusive acetal copolymer sleeve has superior resilience to resist creeping and stress caused from compression.

Product Features:

- Self aligning captive sleeve
- Built-in tube support
- Knurled nuts for hand tightening
- Plastic and brass sleeves available
- Chrome plated and stainless steel side latch couplers available

Markets:

- Dental
- Packaging
- Machine Tools
- Car Wash
- Printing

Applications:

- Pneumatic Systems
- Water Lines
- Dental Equipment

Specifications:

Pressure Range Up to 150 PSI (10.3 bar)

Temperature Range 0° to +150° F (-17.7° to +65.5° C)

O-rings Buna N on chrome plated couplers
Fluorocarbon on Stainless
Steel couplers

Compatible Tubing:

- Polyethylene
- Nylon
- Polypropylene
- Vinyl

Assembly Instructions

Polyethylene, polypropylene and vinyl tubing:

1. Cut tubing squarely—maximum of 15° angle allowable.
2. Check that port or mating part is clean and free of debris.
3. Insert tube end until it bottoms in the Poly-Tite fitting and tighten knurl/hex nut finger-tight — plus one wrench turn.

Tube Support O.D.

TUBE SIZE INCHES	* D1 TUBE SUPPORT O.D.
1/4	.168
5/16	.185
3/8	.248
1/2	.373

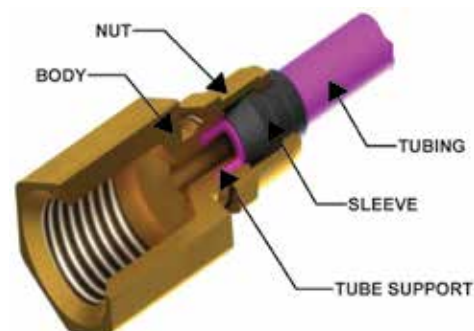
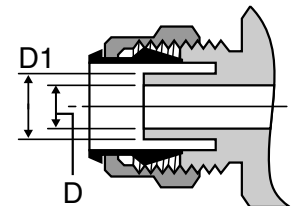

WARNING These products can expose you to chemicals including NICKEL or LEAD, which are known to the state of California to cause cancer, and LEAD which is known to cause birth defects or other reproductive harm. For more information go to www.P65Warnings.ca.gov.

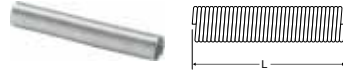

Spring Guard 56PSG

PART NO.	TUBE O. D.	L
56PSG-4	1/4	3.000
56PSG-5	5/16	3.000
56PSG-6	3/8	3.000



Plastic Cap 59P

PART NO.	TUBE SIZE	A	L
59P-4	1/4	.247	.50
59P-6	3/8	.372	.56
59P-8	1/2	.497	.63

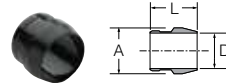

Acetal Plastic Sleeve 60P

PART NO.	TUBE SIZE	A	D	L
60P-4	1/4	.334	.261	.338
60P-5	5/16	.405	.321	.340
60P-6	3/8	.465	.381	.367
60P-8	1/2	.628	.514	.399

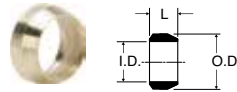

Sleeve 60PB

PART NO.	L	O. D.	I. D.
60PB-4	.187	.336	.255
60PB-5	.187	.400	.318
60PB-6	.218	.460	.382
60PB-8	.250	.620	.507

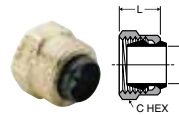

Nut and Plastic Sleeve Assembly 61P

PART NO.	TUBE SIZE	STRAIGHT THREAD	C HEX	D	L
61P-4	1/4	3/8-24	7/16	.261	.38
61P-5	5/16	7/16-24	1/2	.321	.34
61P-6	3/8	1/2-24	9/16	.380	.38
61P-8	1/2	11/16-20	3/4	.514	.44

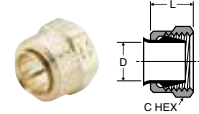

Nut and Brass Sleeve Assembly 61PB

PART NO.	TUBE SIZE	STRAIGHT THREAD	C HEX	D	L
61PB-4	1/4	3/8-24	7/16	.255	.38
61PB-5	5/16	7/16-24	1/2	.318	.34
61PB-6	3/8	1/2-24	9/16	.382	.38
61PB-8	1/2	11/16-20	3/4	.507	.44

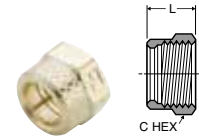

Nut 61PN

PART NO.	TUBE SIZE	STRAIGHT THREAD	C HEX	L
61PN-4	1/4	3/8-24	7/16	.38
61PN-5	5/16	7/16-24	1/2	.34
61PN-6	3/8	1/2-24	9/16	.38
61PN-8	1/2	11/16-20	3/4	.44



Nut only for use with Spring Guard 61PSGN

PART NO.	TUBE O. D.	L	C HEX
61PSGN-4	1/4	.625	.437
61PSGN-5	5/16	.625	.500
61PSGN-6	3/8	.656	.562

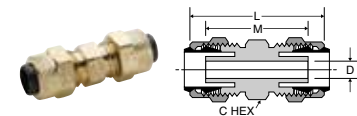

Union 62P

PART NO.	TUBE SIZE	STRAIGHT THREAD	C HEX	L	M	FLOW DIA. D
62P-4	1/4	3/8-24	3/8	1.17	.96	.125
62P-5	5/16	7/16-24	7/16	1.16	.96	.144
62P-6	3/8	1/2-24	1/2	1.23	.99	.204
62P-8	1/2	11/16-20	11/16	1.47	1.24	.323

WARNING These products can expose you to chemicals including NICKEL or LEAD, which are known to the state of California to cause cancer, and LEAD which is known to cause birth defects or other reproductive harm. For more information go to www.P65Warnings.ca.gov.



Union Reducer 62P

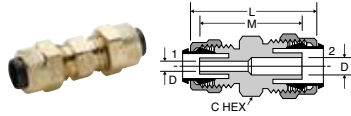

PART NO.	1 TUBE SIZE	2 TUBE SIZE	1 STRAIGHT THREAD	2 STRAIGHT THREAD	C HEX	L	M	FLOW DIA. D
62P-6-4	1/4	3/8	3/8-24	1/2-24	1/2	1.22	.99	.125

Bulkhead Union 62PTBH

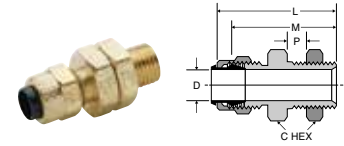

(Straight Through)

PART NO.	TUBE SIZE	STRAIGHT THREAD	C HEX	P MAX.	L	M	BULKHEAD HOLE DIA.	FLOW DIA. D
62PTBH-4	1/4	3/8-24	9/16	.31	1.19	.93	3/8	.260
62PTBH-5	5/16	7/16-24	5/8	.31	1.19	.93	7/16	.323
62PTBH-6	3/8	1/2-24	11/16	.34	1.26	.99	1/2	.387

Bulkhead Union 62PBH

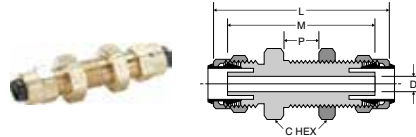

PART NO.	TUBE SIZE	STRAIGHT THREAD	C HEX	P MAX.	L	M	BULKHEAD HOLE DIA.	FLOW DIA. D
62PBH-4	1/4	3/8-24	9/16	.38	1.75	1.53	3/8	.125
62PBH-5	5/16	7/16-24	5/8	.38	1.71	1.52	7/16	.144
62PBH-6	3/8	1/2-24	11/16	.47	1.89	1.65	1/2	.204
62PBH-8	1/2	11/16-20	7/8	.63	2.28	2.05	11/16	.323

Female Connector 66P

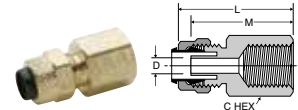

PART NO.	TUBE SIZE	PIPE THREAD	STRAIGHT THREAD	C HEX	L	M	FLOW DIA. D
66P-4-2	1/4	1/8	3/8-24	9/16	.97	.86	.125
66P-4-4	1/4	1/4	3/8-24	5/8	1.18	1.07	.125
66P-5-2	5/16	1/8	7/16-24	9/16	.97	.86	.144
66P-6-4	3/8	1/4	1/2-24	5/8	1.18	1.07	.204
66P-8-6	1/2	3/8	11/16-20	13/16	1.31	1.20	.323

Union 62PCA

(Tube to Compress-Align)

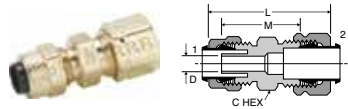

PART NO.	TUBE SIZE	1 STRAIGHT THREAD	2 STRAIGHT THREAD	C HEX	L	M	FLOW DIA. D
62PCA-4	1/4	3/8-24	7/16-24	7/16	1.25	.89	.125
62PCA-5	5/16	7/16-24	1/2-24	1/2	1.30	.92	.144
62PCA-6	3/8	1/2-24	9/16-24	9/16	1.37	.98	.204

Bulkhead Union 62PCABH

(Tube to Compress-Align)

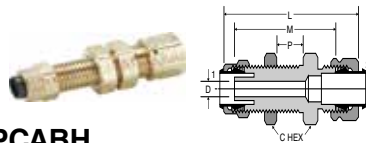

PART NO.	TUBE SIZE	1 STR THD	2 STR THD	C HEX	P MAX	L	M	BLKHD HOLE DIA.	FLOW DIA. D
62PCABH-4	1/4	3/8-24	7/16-24	9/16	.38	1.81	1.45	3/8	.125
62PCABH-6	3/8	1/2-24	9/16-24	11/16	.47	2.03	1.64	1/2	.204

WARNING These products can expose you to chemicals including NICKEL or LEAD, which are known to the state of California to cause cancer, and LEAD which is known to cause birth defects or other reproductive harm. For more information go to www.P65Warnings.ca.gov.



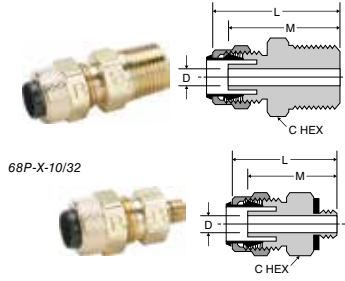

Male Connector 68P

PART NO.	TUBE SIZE	PIPE THREAD	STRAIGHT THREAD	C HEX	L	M	FLOW DIA. D
68P-4-1	1/4	1/16	3/8-24	3/8	1.06	.95	.125
68P-4-10X32	1/4	10-32	3/8-24	3/8	.86	.75	.094
68P-4-2	1/4	1/8	3/8-24	7/16	1.06	.95	.125
68P-4-4	1/4	1/4	3/8-24	9/16	1.25	1.14	.125
68P-4-6	1/4	3/8	3/8-24	11/16	1.28	1.17	.125
68P-5-2	5/16	1/8	7/16-24	7/16	1.05	.95	.144
68P-5-4	5/16	1/4	7/16-24	9/16	1.24	1.14	.144
68P-6-2	3/8	1/8	1/2-24	1/2	1.10	.98	.204
68P-6-4	3/8	1/4	1/2-24	9/16	1.29	1.17	.204
68P-6-6	3/8	3/8	1/2-24	11/16	1.29	1.17	.204
68P-8-4	1/2	1/4	11/16-20	11/16	1.46	1.29	.320
68P-8-6	1/2	3/8	11/16-20	11/16	1.37	1.29	.323

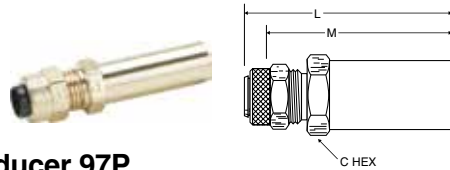

Tube End Reducer 97P

PART NO.	TUBE O. D.	L	M	C HEX
97P-4-6	3/8 X 1/4	1.718	1.625	.437
97P-6-8	1/2 X 3/8	1.875	1.781	.562

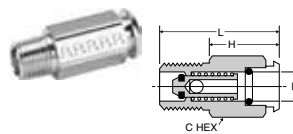

Pipe Coupler Body 391P

(Chrome Plated)

PART NO.	D-INSERT DIA.	PIPE THREAD	C HEX	H	L
391P-4-2	1/4	1/8	1/2	.91	1.29
391P-4-4	1/4	1/4	9/16	.73	1.29
391P-6-4	3/8	1/4	11/16	.85	1.41

Pipe Coupler Body 391PSS

(Stainless Steel)

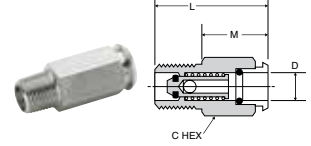

PART NO.	D INSERT DIA.	PIPE THREAD	L	C HEX	M
391PSS-4-2	1/4	1/8	1.271	.500	.900
391PSS-4-4	1/4	1/4	1.271	.562	.710
391PSS-6-4	3/8	1/4	1.40	.625	.840

Bulkhead Coupler Body 392P

(Chrome Plated)

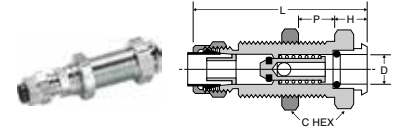

PART NO.	TUBE SIZE	D-INSERT DIA.	STRAIGHT THREAD	C HEX	P MAX.	H	L	BULKHEAD HOLE DIA.
392P-4-4	1/4	1/4	1/2-24	5/8	.84	.39	2.13	1/2
392P-6-6	3/8	3/8	11/16-24	13/16	.93	.37	2.01	11/16

Bulkhead Coupler Body 392PSS

(Stainless Steel)

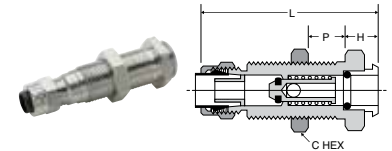

PART NO.	TUBE O. D.	BULKHEAD THREAD	L	C HEX	H	P MAX	BULKHEAD HOLE DIA.
392PSS-4-4	1/4	1/2-24	2.03	.625	.28	.84	1/2
392PSS-6-6	3/8	11/16-24	2.20	.812	.31	.93	11/16

Through Type Insert 393P

(Chrome Plated)

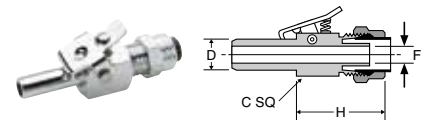

PART NO.	TUBE SIZE	D-INSERT DIA.	STRAIGHT THREAD	C SQUARE	H	FLOW DIA. F
393P-4-4	1/4	1/4	3/8-24	7/16	1.12	.125
393P-6-6	3/8	3/8	1/2-24	1/2	1.34	.203

Through Type Insert 393PSS

(Stainless Steel)

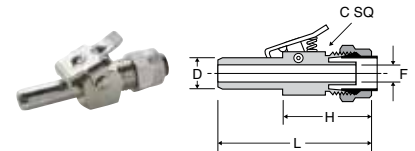

PART NO.	TUBE O. D.	D-INSERT DIA.	L	C SQUARE	H	FLOW DIA. F
393PSS-4-4	1/4	1/4	1.677	7/16	.99	.125
393PSS-6-6	3/8	3/8	2.030	1/2	1.27	.203

WARNING These products can expose you to chemicals including NICKEL or LEAD, which are known to the state of California to cause cancer, and LEAD which is known to cause birth defects or other reproductive harm. For more information go to www.P65Warnings.ca.gov.



Shutoff Type Insert 393PD

(Chrome Plated)

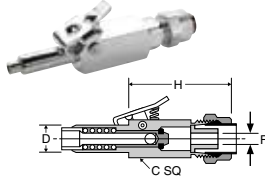

PART NO.	TUBE SIZE	D-INSERT DIA.	STRAIGHT THREAD	C SQUARE	H	FLOW DIA. F
393PD-4-4	1/4	1/4	3/8-24	7/16	1.61	.110
393PD-6-6	3/8	3/8	1/2-24	1/2	1.45	.187

Shut-Off Type Insert 393PDSS

(Stainless Steel)

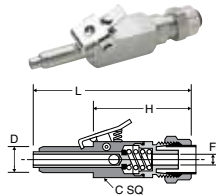

PART NO.	TUBE O.D.	D-INSERT DIA.	L	C SQUARE	H	FLOW DIA. F
393PDSS-4-4	1/4	1/4	2.46	.500	1.62	.116
393PDSS-6-6	3/8	3/8	2.60	.500	1.67	.157

Single End Shutoff Bulkhead Quick Coupler 394P

(Chrome Plated)

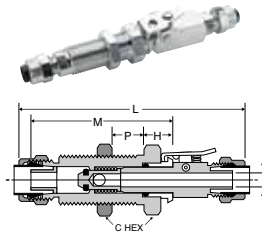

PART NO.	TUBE SIZE	STRAIGHT THREAD	C HEX	P MAX	H	L	M	BULKHEAD HOLE DIA.	FLOW DIA. F
394P-4-4	1/4	1/2-24	5/8	.84	.39	3.28	2.13	1/2	.125
394P-6-6	3/8	11/16-24	13/16	.93	.37	3.41	2.01	11/16	.203

Coupler Single End Shut-Off Bulkhead 394PSS

(Stainless Steel)

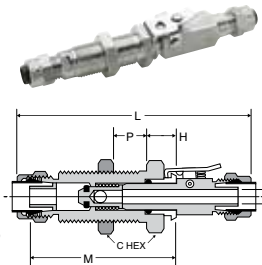

PART NO.	TUBE O.D.	BULKHEAD THREAD	L	M	C HEX	H	P MAX	FLOW DIA. F
394PSS-4-4	1/4	1/2-24	3.05	2.06	.625	.31	.84	.125
394PSS-6-6	3/8	11/16-24	3.50	2.23	.812	.34	.93	.203

Double End Shutoff Bulkhead Quick Coupler 394PD

(Chrome Plated)

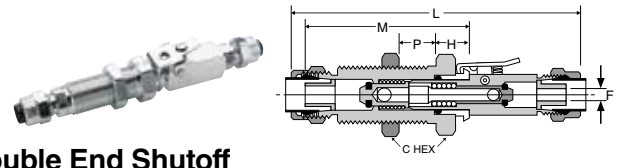

PART NO.	TUBE SIZE	STRAIGHT THREAD	C HEX	P MAX	H	L	M	BULKHEAD HOLE DIA.	FLOW DIA. F
394PD-4-4	1/4	1/2-24	5/8	.84	.39	3.77	2.13	1/2	.125
394PD-6-6	3/8	11/16-24	13/16	.93	.37	3.48	2.01	11/16	.204

Double End Shut-Off Bulkhead Quick Coupler 394PDSS

(Stainless Steel)

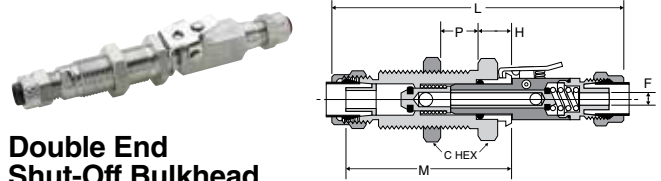

PART NO.	TUBE O.D.	BULKHEAD THREAD	L	M	C HEX	H	P MAX	FLOW DIA. F
394PDSS-4-4	1/4	1/2-24	3.69	2.67	.625	.32	.84	.125
394PDSS-6-6	3/8	11/16-24	3.91	2.24	.812	.34	.93	.203

Single End Shutoff Pipe Connector Quick Coupler 398P

(Chrome Plated)

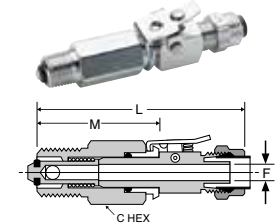

PART NO.	TUBE SIZE	PIPE THREAD	STRAIGHT THREAD	C HEX	L	M	FLOW DIA. F
398P-4-2	1/4	1/8	3/8-24	1/2	2.45	1.32	.125
398P-4-4	1/4	1/4	3/8-24	9/16	2.45	1.32	.125
398P-6-4	3/8	1/4	1/2-24	5/8	2.80	1.46	.203

Single End Shut-Off Connector Quick Coupler 398PSS

(Stainless Steel)

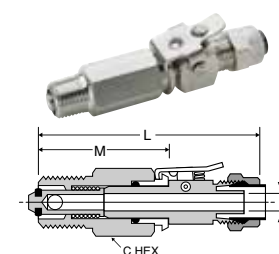

PART NO.	TUBE O.D.	PIPE THREAD	L	M	C HEX	FLOW DIA. F
398PSS-4-2	1/4	1/8	2.30	1.32	.500	.125
398PSS-4-4	1/4	1/4	2.30	1.32	.562	.125
398PSS-6-4	3/8	1/4	2.70	1.43	.625	.203

WARNING These products can expose you to chemicals including NICKEL or LEAD, which are known to the state of California to cause cancer, and LEAD which is known to cause birth defects or other reproductive harm. For more information go to www.P65Warnings.ca.gov.



Double End Shutoff Pipe Connector Quick Coupler 398PD

(Chrome Plated)

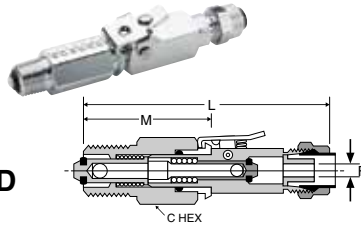

PART NO.	TUBE SIZE	PIPE THREAD	STRAIGHT THREAD	C HEX	L	M	FLOW DIA. F
398PD-4-2	1/4	1/8	3/8-24	1/2	2.93	1.31	.125
398PD-4-4	1/4	1/4	3/8-24	9/16	2.93	1.32	.125
398PD-6-4	3/8	1/4	1/2-24	5/8	2.88	1.43	.204

Double End Shut-Off Pipe Connector Quick Coupler 398PDSS

(Stainless Steel)

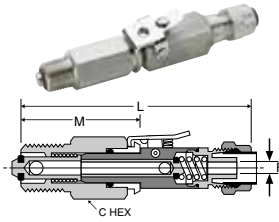

PART NO.	TUBE O. D.	PIPE THREAD	L	M	C HEX	FLOW DIA. D
398PDSS-4-2	1/4	1/8	2.93	1.31	.500	.125
398PDSS-4-4	1/4	1/4	2.93	1.31	.562	.125
398PDSS-6-4	3/8	1/4	3.10	1.43	.625	.125

Union Tee 164P

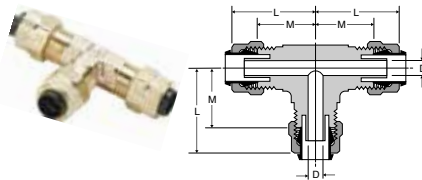

PART NO.	TUBE SIZE	STRAIGHT THREAD	L	M	FLOW DIA. D
164P-4	1/4	3/8-24	.84	.73	.125
164P-5	5/16	7/16-24	.83	.73	.144
164P-6	3/8	1/2-24	.98	.86	.203
164P-8	1/2	11/16-20	1.12	1.04	.323

Union Tee 164P combination size

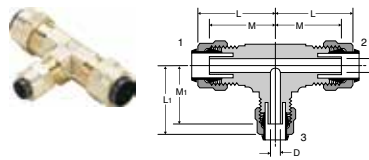

PART NO.	1 TUBE SIZE	2 TUBE SIZE	3 TUBE SIZE	L	L1	M	M1	FLOW DIA. D
164P-6-4	3/8	3/8	1/4	.98	.90	.86	.79	.125

Male Elbow 169P

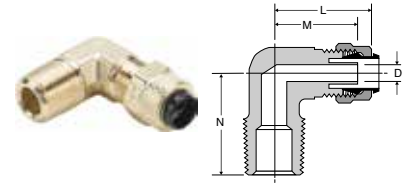

PART NO.	TUBE SIZE	PIPE THREAD	STRAIGHT THREAD	L	M	N	FLOW DIA. D
169P-4-1	1/4	1/16	3/8-24	.92	.58	.67	.130
169P-4-2	1/4	1/8	3/8-24	.84	.73	.75	.121
169P-4-4	1/4	1/4	3/8-24	.90	.79	.92	.125
169P-4-6	1/4	3/8	3/8-24	.93	.84	1.08	.125
169P-5-2	5/16	1/8	7/16-24	.87	.73	.68	.144
169P-6-2	3/8	1/8	1/2-24	.93	.81	.73	.203
169P-6-4	3/8	1/4	1/2-24	.98	.86	1.05	.203
169P-6-6	3/8	3/8	1/2-24	.98	.86	1.08	.203
169P-8-6	1/2	3/8	11/16-20	1.12	1.04	1.13	.323

Long Male Elbow 169LP

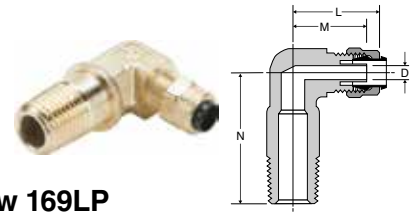

PART NO.	TUBE SIZE	PIPE THREAD	STRAIGHT THREAD	L	M	N	FLOW DIA. D
169LP-4-4	1/4	1/4	3/8-24	.90	.79	1.38	.125

Male Elbow Swivel 169PS

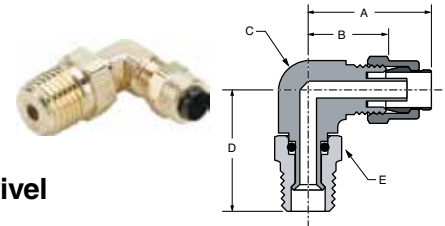

PART NO.	TUBE O. D.	PIPE THREAD	A	B	C HEX	D	E
169PS-4-2	1/4	1/8	.812	.594	.375	.862	.437
169PS-4-4	1/4	1/4	.906	.688	.562	1.218	.562
169PS-6-2	3/8	1/8	.875	.625	.437	.904	.437
169PS-6-4	3/8	1/4	.937	.685	.562	1.218	.562
169PS-6-6	3/8	3/8	.859	.602	.562	1.190	.687
169PS-8-6	1/2	3/8	1.031	.782	.500	1.218	.687

WARNING These products can expose you to chemicals including NICKEL or LEAD, which are known to the state of California to cause cancer, and LEAD which is known to cause birth defects or other reproductive harm. For more information go to www.P65Warnings.ca.gov.

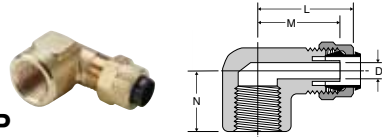

Female Elbow 170P

PART NO.	TUBE SIZE	PIPE THREAD	STRAIGHT THREAD	L	M	N	FLOW DIA.D
170P-4-2	1/4	1/8	3/8-24	.90	.79	.56	.125
170P-4-4	1/4	1/4	3/8-24	1.00	.89	.69	.125
170P-6-4	3/8	1/4	1/2-24	1.01	.89	.69	.204
170P-8-6	1/2	3/8	11/16-20	1.19	1.11	1.13	.323

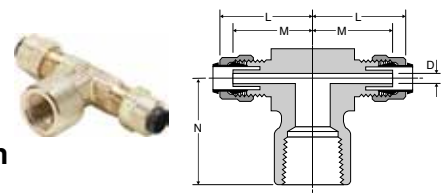

Female Branch Tee 177P

PART NO.	TUBE SIZE	PIPE THREAD	STRAIGHT THREAD	L	M	N	FLOW DIA.D
177P-4-2	1/4	1/8	3/8-24	.92	.81	.88	.125
177P-4-4	1/4	1/4	3/8-24	.92	.81	1.03	.125
177P-4-6	1/4	3/8	3/8-24	1.03	.92	1.13	.125

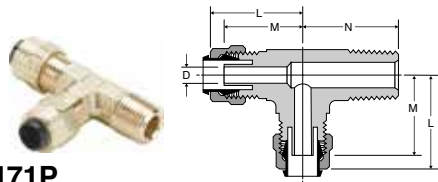

Male Run Tee 171P

PART NO.	TUBE SIZE	PIPE THREAD	STRAIGHT THREAD	L	M	N	FLOW DIA.D
171P-4-2	1/4	1/8	3/8-24	.84	.73	.72	.125
171P-4-4	1/4	1/4	3/8-24	.92	.81	.92	.125
171P-5-2	5/16	1/8	7/16-24	.83	.73	.72	.144
171P-6-4	3/8	1/4	1/2-24	.98	.86	1.03	.203
171P-8-6	1/2	3/8	11/16-20	1.12	1.04	1.13	.323

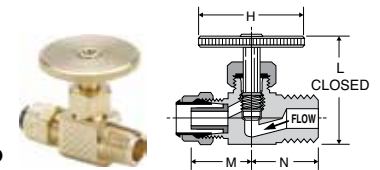

Needle Valve NV311P

PART NO.	TUBE SIZE	PIPE THREAD	H	L OPEN	L CLOSED	M	N
NV311P-4-2	1/4	1/8	1.06	1.36	1.16	.64	.63
NV311P-4-4	1/4	1/4	1.06	1.38	1.18	.64	.72
NV311P-6-4	3/8	1/4	1.06	1.38	1.18	.64	.72

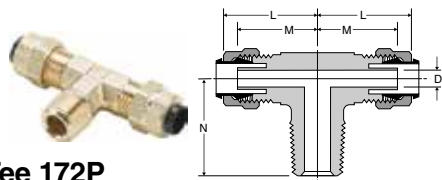

Male Branch Tee 172P

PART NO.	TUBE SIZE	PIPE THREAD	STRAIGHT THREAD	L	M	N	FLOW DIA.D
172P-4-2	1/4	1/8	3/8-24	.84	.73	.72	.125
172P-4-4	1/4	1/4	3/8-24	.92	.81	.92	.125
172P-5-2	5/16	1/8	7/16-24	.83	.73	.72	.144
172P-6-2	3/8	1/8	1/2-24	.88	.86	.74	.204
172P-6-4	3/8	1/4	1/2-24	.98	.86	1.03	.204
172P-8-6	1/2	3/8	11/16-20	1.12	1.04	1.13	.323

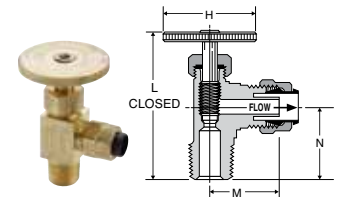

Angle Needle Valve NV312P

PART NO.	TUBE SIZE	PIPE THREAD	H	L OPEN	L CLOSED	M	N
NV312P-4-2	1/4	1/8	1.06	1.70	1.50	.63	.68
NV312P-4-4	1/4	1/4	1.06	2.07	1.82	.71	.86
NV312P-6-4	3/8	1/4	1.06	2.00	1.75	.74	.86

WARNING These products can expose you to chemicals including NICKEL or LEAD, which are known to the state of California to cause cancer, and LEAD which is known to cause birth defects or other reproductive harm. For more information go to www.P65Warnings.ca.gov.



Hi-Duty Flareless Tube Fittings

Parker's Hi-Duty Fittings are preassembled with the sleeve machined onto the nut. During assembly the sleeve breaks away from the nut and creates a seal on the tubing. Rated to a much higher pressure rating than compression fittings, Hi-Duty will work with seamless steel tubing as well as copper, brass and thermoplastic tubing.

Product Features:

- All brass construction
- Two piece fitting
- Higher pressure rating
- Easy assembly

Markets:

- Mobile
- Industrial
- Compressors
- Lubrication

Applications:

- Lubrication Lines
- Coolant Lines
- Oil Lines
- Engines

Compatible Tubing:

- Copper
- Brass
- Seamless Steel
- Thermoplastic Tubing

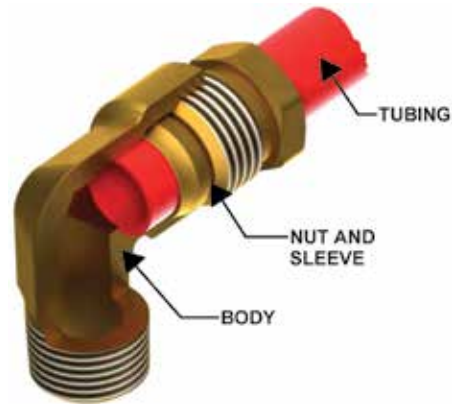

Specifications:

Temperature Range: -65° to +250° F (-53.8° to +121.1° C)

Pressure Range:

TUBE SIZE	PSI	bar	TUBE SIZE	PSI	bar
1/8	4300	296.4	3/8	1500	103.4
3/16	2850	196.5	1/2	1150	79.2
1/4	2100	144.7	5/8	1000	68.9
5/16	1800	124.1			

Assembly Instructions

1. Cut tube squarely and cleanly removing all burrs.
2. Grasp fitting. Do not remove nut.
3. Insert tube in fitting through nut until tube seats firmly against tube shoulder in body.
4. Grip tube firmly to prevent turning and tighten nut to finger-tight. Continue to tighten for one and three-quarter additional turns (one and one-half turns for 1/2" size fittings) for a positive, leak proof seal. During tightening a slight "give" will be felt. This "give" indicates the sleeve has been sheared from the nut. It is not necessary to tighten the nut all the way down.



WARNING These products can expose you to chemicals including LEAD which is known to the state of California to cause cancer and birth defects or other reproductive harm. For more information go to www.P65Warnings.ca.gov.



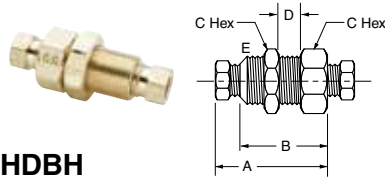

Bulkhead Union 62HDBH

PART NO.	TUBE SIZE	MIN. ORIFICE SIZE	A	B	C	D	E
62HDBH-2	1/8	.093	1.781	1.156	.562	.625	7/16-24
62HDBH-4	1/4	.187	1.968	1.156	.687	.625	9/16-24

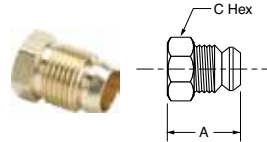

Nut/Sleeve 61HD

PART NO.	TUBE SIZE	PIPE THREAD	A	C
61HD-2	1/8	5/16-24	.656	.312
61HD-3	3/16	3/8-24	.687	.375
61HD-4	1/4	7/16-24	.734	.437
61HD-5	5/16	1/2-20	.765	.500
61HD-6	3/8	9/16-20	.843	.562
61HD-8	1/2	1 1/16-16	.921	.688
61HD-10	5/8	7/8-18	1.078	.875

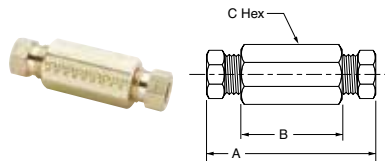

Union 62HD

PART NO.	TUBE SIZE	MIN. ORIFICE SIZE	A	B	C
62HD-2	1/8	.093	1.687	1.062	.375
62HD-3	3/16	.125	1.781	1.031	.437
62HD-4	1/4	.187	1.906	1.093	.562
62HD-6	3/8	.312	2.187	1.375	.625
62HD-8	1/2	.437	2.437	1.562	.812
62HD-10	5/8	.500	2.937	1.812	1.062

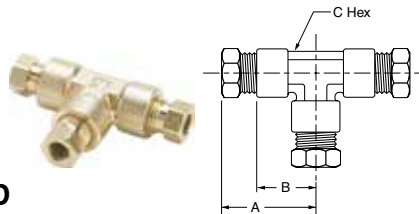

Union Tee 164HD

PART NO.	TUBE SIZE	MIN. ORIFICE SIZE	A	B	C HEX
164HD-4	1/4	.187	1.082	.687	.500
164HD-6	3/8	.312	1.357	.970	.562
164HD-8	1/2	.437	1.481	1.060	.750

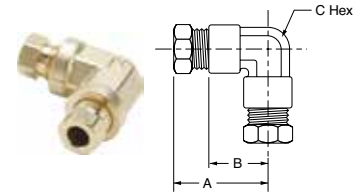

Union Elbow 165HD

PART NO.	TUBE SIZE	MIN. ORIFICE SIZE	A	B	C HEX
165HD-4	1/4	.187	1.084	.690	.552
165HD-6	3/8	.312	1.376	.970	.615
165HD-8	1/2	.437	1.546	1.060	.750

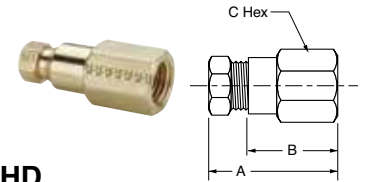

Female Connector 66HD

PART NO.	TUBE SIZE	PIPE THREAD	MIN. ORIFICE SIZE	A	B	C HEX
66HD-2-2	1/8	1/8	.093	1.312	1.000	.500
66HD-4-2	1/4	1/8	.187	1.406	1.000	.562
66HD-4-4	1/4	1/4	.187	1.593	1.187	.687
66HD-6-2	3/8	1/8	.312	1.531	1.125	.625
66HD-6-4	3/8	1/4	.312	1.718	1.312	.625
66HD-6-6	3/8	3/8	.312	1.750	1.343	.812

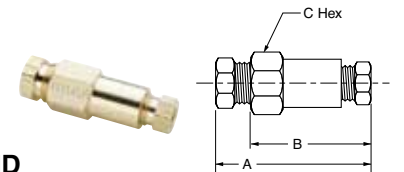

Reducing Union 62HD

PART NO.	TUBE SIZE	MIN. ORIFICE SIZE	A	B	C HEX
62HD-6-4	3/8 X 1/4	.187	2.000	1.187	.625
62HD-8-4	1/2 X 1/4	.187	2.125	1.281	.812
62HD-8-6	1/2 X 3/8	.312	2.656	1.406	.812

WARNING These products can expose you to chemicals including LEAD which is known to the state of California to cause cancer and birth defects or other reproductive harm. For more information go to www.P65Warnings.ca.gov.



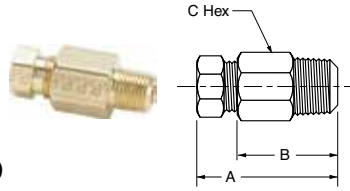

Male Connector 68HD

PART NO.	TUBE SIZE	PIPE THREAD	MIN. ORIFICE SIZE	A	B	C HEX
68HD-2-2	1/8	1/8	.093	1.062	.750	.437
68HD-3-2	3/16	1/8	.125	1.140	.765	.437
68HD-4-2	1/4	1/8	.187	1.343	.937	.562
68HD-4-4	1/4	1/4	.187	1.468	1.062	.562
68HD-4-6	1/4	3/8	.187	1.343	.937	.687
68HD-4-8	1/4	1/2	.187	1.531	1.125	.875
68HD-5-2	5/16	1/8	.218	1.406	1.000	.562
68HD-5-4	5/16	1/4	.218	1.500	1.093	.562
68HD-6-2	3/8	1/8	.218	1.531	1.125	.625
68HD-6-4	3/8	1/4	.312	1.656	1.250	.625
68HD-6-6	3/8	3/8	.312	1.531	1.125	.687
68HD-6-8	3/8	1/2	.312	1.531	1.125	.875
68HD-8-4	1/2	1/4	.312	1.813	1.375	.812
68HD-8-6	1/2	3/8	.406	1.750	1.312	.812
68HD-8-8	1/2	1/2	.437	1.812	1.375	.875
68HD-8-12	1/2	3/4	.437	1.625	1.187	1.062
68HD-10-6	5/8	3/8	.406	2.031	1.468	1.062
68HD-10-8	5/8	1/2	.500	2.156	1.593	1.062

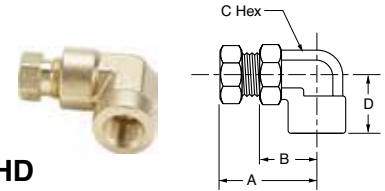

Female Elbow 170HD

PART NO.	TUBE SIZE	PIPE THREAD	MIN. ORIFICE SIZE	A	B	C HEX	D
170HD-2-2	1/8	1/8	.093	1.005	.690	.500	.750
170HD-4-2	1/4	1/8	.187	1.084	.687	.500	.750
170HD-4-4	1/4	1/4	.187	1.234	.843	.562	.875
170HD-6-2	3/8	1/8	.312	1.281	.875	.562	.937
170HD-6-4	3/8	1/4	.312	1.376	.970	.615	1.093
170HD-6-6	3/8	3/8	.312	1.526	1.120	.690	1.150
170HD-8-6	1/2	3/8	.437	1.481	1.062	.740	1.281

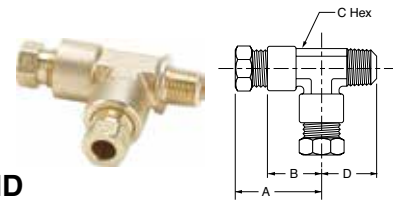

Male Run Tee 171HD

PART NO.	TUBE SIZE	PIPE THREAD	MIN. ORIFICE SIZE	A	B	C HEX	D
171HD-4-2	1/4	1/8	.187	1.144	.750	.500	.780
171HD-4-4	1/4	1/4	.187	1.207	.812	.500	.937
171HD-6-4	3/8	1/4	.312	1.376	.970	.562	1.000

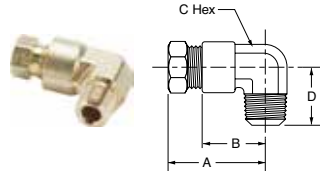

Male Elbow 169HD

PART NO.	TUBE SIZE	PIPE THREAD	MIN. ORIFICE SIZE	A	B	C HEX	D
169HD-2-2	1/8	1/8	.093	.975	.656	.438	.720
169HD-3-2	3/16	1/8	.125	1.056	.687	.437	.750
169HD-4-2	1/4	1/8	.187	1.084	.687	.500	.750
169HD-4-4	1/4	1/4	.187	1.144	.750	.500	.937
169HD-5-2	5/16	1/8	.218	1.144	.750	.562	.810
169HD-5-4	5/16	1/4	.250	1.206	.812	.562	1.000
169HD-6-2	3/8	1/8	.218	1.281	.875	.562	.875
169HD-6-4	3/8	1/4	.312	1.281	.875	.562	1.000
169HD-6-6	3/8	3/8	.312	1.376	.970	.615	1.031
169HD-6-8	3/8	1/2	.312	1.526	1.120	.687	1.310
169HD-8-4	1/2	1/4	.312	1.421	1.000	.678	1.062
169HD-8-6	1/2	3/8	.406	1.421	1.000	.678	1.062
169HD-8-8	1/2	1/2	.437	1.481	1.060	.740	1.420
169HD-10-6	5/8	3/8	.406	1.818	1.270	.875	1.340
169HD-10-8	5/8	1/2	.500	1.818	1.270	.875	1.480

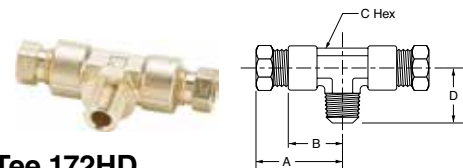

Male Branch Tee 172HD

PART NO.	TUBE SIZE	PIPE THREAD	MIN. ORIFICE SIZE	A	B	C HEX	D
172HD-4-2	1/4	1/8	.187	1.082	.687	.500	.780
172HD-4-4	1/4	1/4	.187	1.269	.875	.500	.937
172HD-6-6	3/8	3/8	.312	1.406	1.000	.562	1.125

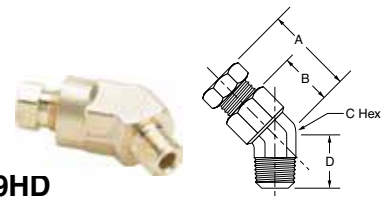

45° Male Elbow 179HD

PART NO.	TUBE SIZE	PIPE THREAD	MIN. ORIFICE SIZE	A	B	C HEX	D
179HD-4-2	1/4	1/8	.187	1.093	.687	.562	.750
179HD-6-4	3/8	1/4	.280	1.138	.710	.550	.850

WARNING These products can expose you to chemicals including LEAD which is known to the state of California to cause cancer and birth defects or other reproductive harm. For more information go to www.P65Warnings.ca.gov.

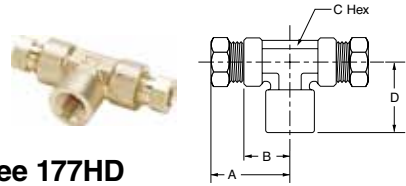

Female Branch Tee 177HD

PART NO.	TUBE SIZE	PIPE THREAD	MIN. ORIFICE SIZE	A	B	C HEX	D
177HD-4-2	1/4	1/8	.187	1.082	.687	.500	.750
177HD-4-4	1/4	1/4	.187	1.144	.750	.562	1.093
177HD-6-4	3/8	1/4	.312	1.376	.970	.562	1.093

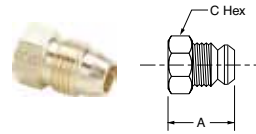

Plug 59HD

PART NO.	TUBE SIZE	A	C
59HD-4	1/4	.734	.437
59HD-6	3/8	.843	.625

WARNING These products can expose you to chemicals including LEAD which is known to the state of California to cause cancer and birth defects or other reproductive harm. For more information go to www.P65Warnings.ca.gov.



Industrial Flare Fittings

45° Flare Fittings

Inverted Flare Fittings























Access Valves





Flare to Male NPT	48F Male Connector  p. H9	145F Branch Tee  p. H10	149F-249F Male Elbow  p. H10	151F Run Tee  p. H11	159F-259F 45° Male Elbow  p. H11	256F Adapter Tee  p. H12	
	48IFHD Male Connector  p. H14	245IFHD Branch Tee  p. H15	249IFHD-249IF Male Elbow  p. H15	251IFHD Run Tee  p. H15	259IFHD 45° Male Elbow  p. H15	AVU1 Male Connector  p. H17	AVE1 Male Elbow  p. H17
AVT3 Run Tee  p. H17	AVC1 Cross  p. H17	Flare to Straight Thread	485F Male Connector  p. H9	1495F Male Elbow  p. H11	1595F 45° Male Elbow  p. H12	AVUIFI Male Connector  p. H17	
Flare to Metric Straight Thread			48F-X-MIX Male Connector  p. H9	149F-X-MIX Male Elbow  p. H11	159F-X-MIX 45° Male Elbow  p. H12	Flare to Solder	
		US5 Flare Adapter  p. H7	43F Connector  p. H8				
AVUSE Extended Copper Tube  p. H17	AVTS Solder Tee  p. H17	AVUS3 3 Way Solder  p. H18	AVUS Solder Connector  p. H18	Flare to Female NPT		46F Female Connector  p. H9	150F Female Elbow  p. H11
46IFHD Female Connector  p. H14	250IFHD Female Elbow  p. H15	252IFHD Branch Tee  p. H15	Flare to Flare			14FSV Swivel Nut Connector  p. H7	42F Union  p. H8
155F Union Elbow  p. H11	166FSV Swivel Elbow  p. H12	660FHD Union  p. H12			42IFHD Union  p. H14	244IFHD Union Tee  p. H14	255IFHD Branch Tee  p. H15
AVUR3 Female Connector  p. H17	AVUS4D Swivel Connector  p. H18	AVTS4 Run Tee  p. H18	AVTS6 Branch Tee  p. H18				

WARNING These products can expose you to chemicals including LEAD which is known to the state of California to cause cancer and birth defects or other reproductive harm. For more information go to www.P65Warnings.ca.gov.

Bulkhead Union	AVU2BH Bulkhead Union	AVUS3BH Bulkhead Union	Adapter	1F Refrigerant Drum	661FHD Reducer	664FHD Female Flare - Pipe
	 p. H17	 p. H17		 p. H7	 p. H12	 p. H12
88AC Refrigerant Adapter	880AC Refrigerant Adapter	881AC Refrigerant Adapter	Auxiliary Component	2GF Flare Gasket	3GF Seal Bonnet	14FL Long forged Nut
 p. H18	 p. H18	 p. H18		 p. H7	 p. H7	 p. H7
14FSX Short Forged Nut	41FL Long Nut	41FS Short Nut	639F Seal Plug	640F Cap Nut	411F Inverted Flare Nut	411FS Inverted Flare Nut Steel
 p. H7	 p. H8	 p. H8	 p. H12	 p. H12	 p. H14	 p. H14
411FF Inverted Flare Piloted Nut	640QSF Seal Cap	640QSFCR Seal Cap with Core Remover	CR Core Remover	VC Valve Core		
 p. H14	 p. H18	 p. H18	 p. H18	 p. H18		

WARNING These products can expose you to chemicals including LEAD which is known to the state of California to cause cancer and birth defects or other reproductive harm. For more information go to www.P65Warnings.ca.gov.

45° Flare Fittings



Parker's Flare Fittings is an economical choice for a metal-to-metal seal that resists mechanical pullout. Meets functional requirements of SAE J512 and SAE J513.

Product Features:

- All brass construction
- Resists vibration with use of long nut
- UL listing
- Functional requirements of SAE J512 and J513

Markets:

- Refrigeration
- Heavy Duty Truck
- Mobile
- Industrial
- Heating
- Air Conditioning

Specifications:

Temperature Range: -65° to +250° F (-53.8° to 121.1° C)

Pressure Range:

TUBE SIZE	PSI	bar	TUBE SIZE	PSI	bar
1/8	2800	193.0	3/8	1000	68.9
3/16	1900	131.0	1/2	750	51.7
1/4	1400	96.5	5/8	650	44.8
5/16	1200	82.7	3/4	550	37.9

Applications:

- Refrigerant Lines
- Propane
- Fuels
- Adapters
- Natural Gas

Compatible Tubing:

- Copper
- Brass
- Aluminum
- Welded Steel Hydraulic Tubing



Assembly Instructions

1. Cut tubing squarely and clean tube end thoroughly to remove burrs.
2. Place nut onto tube. Place threaded end of nut toward end of tube.
3. Flare tube end with flaring tool to provide 45° flare.
4. Clamp tube flare between nut and nose of fitting body by screwing nut on finger-tight. Tighten with a wrench an additional 1/4 to 1/2 turn past finger-tight for a metal-to-metal seal.



WARNING These products can expose you to chemicals including LEAD which is known to the state of California to cause cancer and birth defects or other reproductive harm. For more information go to www.P65Warnings.ca.gov.



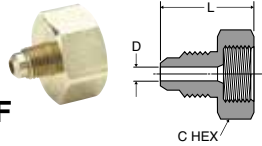

Refrigerant Drum Adapter 1F

Ref. SAE 010165

PART NO.	TUBE O.D.	PIPE THREAD	C HEX	L	FLOW DIA. D
1F-4-8	1/4	1/2	1-1/8	1.12	.189
1F-4-12*	1/4	3/4	1-1/4	1.12	.189
1F-6-12*	3/8	3/4	1-1/4	1.24	.282
1F-8-12*	1/2	3/4	1-1/4	1.37	.407

Gasket Furnished with each 1F adapter



Copper Flare Gasket 2GF

REF. SAE 010113

PART NO.	TUBE SIZE	A
2GF-3	3/16	.32
2GF-4	1/4	.36
2GF-5	5/16	.43
2GF-6	3/8	.56
2GF-8	1/2	.67
2GF-10	5/8	.78
2GF-12	3/4	.97



Seal Bonnet 3GF

REF. SAE 010114

PART NO.	TUBE SIZE	A
3GF-3	3/16	.32
3GF-4	1/4	.37
3GF-5	5/16	.43
3GF-6	3/8	.56
3GF-8	1/2	.67
3GF-10	5/8	.78
3GF-12	3/4	.97

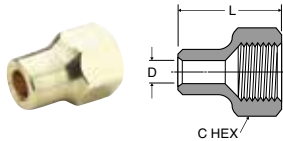

Long Forged Nut 14FL

REF. SAE 010167

PART NO.	TUBE SIZE	STRAIGHT THREAD	C HEX	D	L
14FL-4	1/4	7/16-20	5/8	.257	.94
14FL-6	3/8	5/8-18	13/16	.382	1.06
14FL-8	1/2	3/4-16	15/16	.507	1.19
14FL-10	5/8	7/8-14	1-1/16	.632	1.44

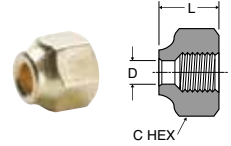

Short Forged Nut 14FSX

REF. SAE 010166

PART NO.	TUBE SIZE	STRAIGHT THREAD	C HEX	D	L
14FSX-4	1/4	7/16-20	5/8	.257	.63
14FSX-5	5/16	1/2-20	11/16	.320	.67
14FSX-6	3/8	5/8-18	13/16	.382	.74
14FSX-8	1/2	3/4-16	15/16	.507	.86
14FSX-10	5/8	7/8-14	1-1/16	.632	.97
14FSX-12	3/4	1-1/16-14	1-5/16	.757	1.17

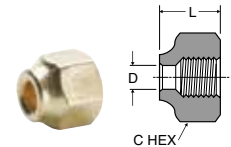

Short Forged Reducing Nuts 14FS

PART NO.	TUBE SIZE	STRAIGHT THREAD	C HEX	D	L
14FS-6-4	3/8 TO 1/4	5/8-18	13/16	.257	.74
14FS-8-6	1/2 TO 3/8	3/4-16	15/16	.382	.86
14FS-10-8	5/8 TO 1/2	7/8-14	1-1/16	.507	.99

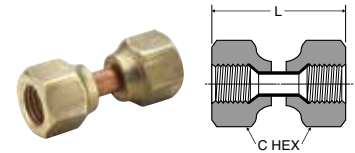

Swivel Nut Valve Connector 14FSV

REF. SAE 010108

PART NO.	TUBE SIZE	STRAIGHT THREAD	C HEX	L MIN.
14FSV-4	1/4	7/16-20	5/8	1.31
14FSV-6	3/8	5/8-18	13/16	1.50
14FSV-8	1/2	3/4-16	15/16	1.75
14FSV-10	5/8	7/8-14	1-1/16	2.00

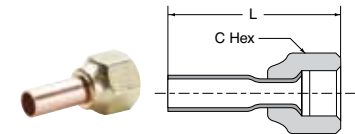

Flare Adapter US5

PART NO.	TUBE SIZE	STRAIGHT THREAD	C HEX	L
US5-4	1/4	7/16-20	5/8	1.50
US5-6	3/8	5/8-18	13/16	1.58
US5-8	1/2	3/4-16	15/16	1.80

WARNING These products can expose you to chemicals including LEAD which is known to the state of California to cause cancer and birth defects or other reproductive harm. For more information go to www.P65Warnings.ca.gov.



Long Nut 41FL

REF. SAE 010111

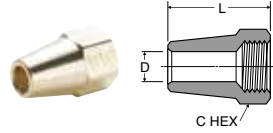

PART NO.	TUBE SIZE	STRAIGHT THREAD	C HEX	D	L
41FL-2	1/8	5/16-24	3/8	.133	.75
41FL-3	3/16	3/8-24	7/16	.195	.81
41FL-4	1/4	7/16-20	9/16	.257	.94
41FL-5	5/16	1/2-20	5/8	.320	1.12
41FL-6	3/8	5/8-18	3/4	.382	1.31
41FL-8	1/2	3/4-16	7/8	.507	1.62
41FL-10	5/8	7/8-14	1-1/16	.632	1.88
41FL-12	3/4	1-1/16-14	1-1/4	.757	2.19

Short Nut 41FS / Shorter Nut 41FX

REF. SAE 010110

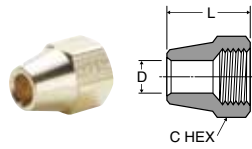

PART NO.	TUBE SIZE	STRAIGHT THREAD	C HEX	D	L
41FS-2	1/8	5/16-24	3/8	.132	.50
41FS-3	3/16	3/8-24	7/16	.195	.62
41FS-4	1/4	7/16-20	9/16	.257	.75
41FS-5	5/16	1/2-20	5/8	.320	.88
41FS-6	3/8	5/8-18	3/4	.382	1.00
41FX-6	3/8	5/8-18	3/4	.382	.91
41FS-8	1/2	3/4-16	7/8	.507	1.12
41FX-8	1/2	3/4-16	7/8	.507	1.00
41FS-10	5/8	7/8-14	1-1/16	.632	1.31
41FX-10	5/8	7/8-14	1-1/16	.632	1.06
41FX-12	3/4	1-1/16-14	1-1/4	.757	1.17
41FS-12	3/4	1-1/16-14	1-1/4	.757	1.50
41FS-14	7/8	1-1/4-12	1-1/2	.882	1.62

Union 42F

REF. SAE 010101 *THREAD PROTECTORS

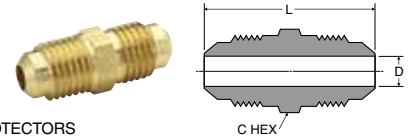

PART NO.	TUBE SIZE	STRAIGHT THREAD	C HEX	L	D
42F-2	1/8	5/16-24	5/16	.90	.079
42F-3	3/16	3/8-24	3/8	1.04	.125
42F-4	1/4	7/16-20	7/16	1.17	.189
42F-5	5/16	1/2-20	1/2	1.32	.220
42F-6	3/8	5/8-18	5/8	1.48	.282
42F-8	1/2	3/4-16	3/4	1.79	.407
42F-10	5/8	7/8-14	7/8	2.10	.501
42F-12*	3/4	1-1/16-14	1-1/16	2.42	.626
42F-14*	7/8	1-1/4-12	1-1/4	2.72	.751

Union Reducers 42F

REF. SAE 010101

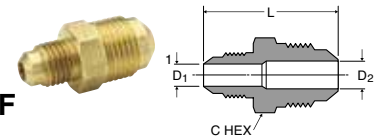

PART NO.	1 TUBE SIZE	2 TUBE SIZE	1 STRAIGHT THREAD	2 STRAIGHT THREAD	C HEX	L	FLOW DIA. D1	FLOW DIA. D2
42F-6-4	1/4	3/8	7/16-20	5/8-18	5/8	1.36	.189	.282
42F-6-5	5/16	3/8	1/2-20	5/8-18	5/8	1.42	.220	.282
42F-8-4	1/4	1/2	7/16-20	3/4-16	3/4	1.54	.189	.407
42F-8-6	3/8	1/2	5/8-18	3/4-16	3/4	1.67	.282	.407
42F-10-6	3/8	5/8	5/8-18	7/8-14	7/8	1.86	.282	.501
42F-10-8	1/2	5/8	3/4-16	7/8-14	7/8	1.98	.407	.501

Flare to Solder 43F

REF. SAE 010104

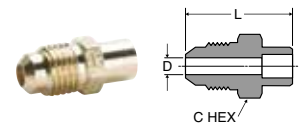

PART NO.	TUBE SIZE	SOLDER OD	STRAIGHT THREAD	C HEX	L	FLOW DIA. D
43F-4-4	1/4	1/4	7/16-20	7/16	.98	.189
43F-4-5	1/4	5/16	7/16-20	7/16	.98	.189
43F-4-6	1/4	3/8	7/16-20	1/2	.98	.189
43F-6-4	3/8	1/4	5/8-18	5/8	1.17	.189
43F-6-5	3/8	5/16	5/8-18	5/8	1.17	.252
43F-6-6	3/8	3/8	5/8-18	5/8	1.17	.282
43F-6-8	3/8	1/2	5/8-18	5/8	1.23	.282
43F-6-10	3/8	5/8	5/8-18	3/4	1.36	.282
43F-8-6	1/2	3/8	3/4-16	3/4	1.36	.314
43F-8-8	1/2	1/2	3/4-16	3/4	1.42	.407
43F-8-10	1/2	5/8	3/4-16	3/4	1.54	.407
43F-10-8	5/8	1/2	7/8-14	7/8	1.60	.440
43F-10-10	5/8	5/8	7/8-14	7/8	1.73	.501
43F-10-12*	5/8	3/4	7/8-14	7/8	1.86	.501
43F-12-12*	3/4	3/4	1-1/16-14	1-1/16	2.04	.626
43F-12-14*	3/4	7/8	1-1/16-14	1-1/16	2.17	.626

*Comes standard with thread protectors

WARNING These products can expose you to chemicals including LEAD which is known to the state of California to cause cancer and birth defects or other reproductive harm. For more information go to www.P65Warnings.ca.gov.

Female Connector 46F

REF. SAE 010103

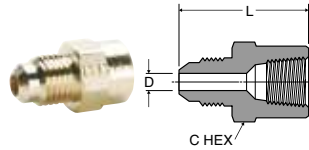

PART NO.	TUBE SIZE	PIPE THREAD	STRAIGHT THREAD	C HEX	L	FLOW DIA. D
46F-2-2	1/8	1/8	5/16-24	9/16	.91	.078
46F-3-2	3/16	1/8	3/8-24	9/16	.95	.125
46F-4-2	1/4	1/8	7/16-20	9/16	1.01	.189
46F-4-4	1/4	1/4	7/16-20	11/16	1.23	.189
46F-4-6	1/4	3/8	7/16-20	13/16	1.26	.189
46F-5-2	5/16	1/8	1/2-20	9/16	1.05	.220
46F-5-4	5/16	1/4	1/2-20	11/16	1.26	.220
46F-6-2	3/8	1/8	5/8-18	5/8	1.10	.282
46F-6-4	3/8	1/4	5/8-18	11/16	1.29	.282
46F-6-6	3/8	3/8	5/8-18	13/16	1.36	.282
46F-6-8	3/8	1/2	5/8-18	1	1.60	.282
46F-8-4	1/2	1/4	3/4-16	3/4	1.39	.407
46F-8-6	1/2	3/8	3/4-16	13/16	1.48	.407
46F-8-8	1/2	1/2	3/4-16	1	1.73	.407
46F-8-12*	1/2	3/4	3/4-16	1-1/4	1.79	.407
46F-10-6	5/8	3/8	7/8-14	7/8	1.57	.501
46F-10-8	5/8	1/2	7/8-14	1	1.80	.501
46F-10-12*	5/8	3/4	7/8-14	1-1/4	1.89	.501

Male Connector 48F

REF. SAE 010102

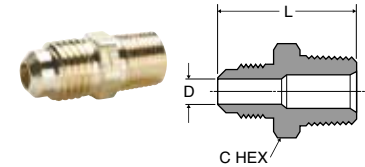

PART NO.	TUBE SIZE	PIPE THREAD	STRAIGHT THREAD	C HEX	L	FLOW DIA. D
48F-2-2	1/8	1/8	5/16-24	7/16	.91	.078
48F-3-2	3/16	1/8	3/8-24	7/16	.98	.125
48F-3-4	3/16	1/4	3/8-24	9/16	1.17	.125
48F-4-2	1/4	1/8	7/16-20	7/16	1.04	.189
48F-4-4	1/4	1/4	7/16-20	9/16	1.23	.189
48F-4-6	1/4	3/8	7/16-20	11/16	1.29	.189
48F-4-8	1/4	1/2	7/16-20	7/8	1.54	.189
48F-5-2	5/16	1/8	1/2-20	1/2	1.14	.220
48F-5-4	5/16	1/4	1/2-20	9/16	1.32	.220
48F-5-6	5/16	3/8	1/2-20	11/16	1.36	.220
48F-6-2	3/8	1/8	5/8-18	5/8	1.23	.220
48F-6-4	3/8	1/4	5/8-18	5/8	1.42	.282
48F-6-6	3/8	3/8	5/8-18	11/16	1.42	.282
48F-6-8	3/8	1/2	5/8-18	7/8	1.67	.282
48F-6-12*	3/8	3/4	5/8-18	1-1/16	1.79	.282
48F-8-4	1/2	1/4	3/4-16	3/4	1.60	.407
48F-8-6	1/2	3/8	3/4-16	3/4	1.60	.407
48F-8-8	1/2	1/2	3/4-16	7/8	1.79	.407
48F-8-12	1/2	3/4	3/4-16	1-1/16	1.92	.407
48F-10-4	5/8	1/4	7/8-14	7/8	1.79	.313
48F-10-6	5/8	3/8	7/8-14	7/8	1.79	.408
48F-10-8	5/8	1/2	7/8-14	7/8	1.98	.501
48F-10-12*	5/8	3/4	7/8-14	1-1/16	2.04	.501
48F-12-8*	3/4	1/2	1-1/16-14	1-1/16	2.17	.563
48F-12-12*	3/4	3/4	1-1/16-14	1-1/16	2.17	.626
48F-14-12*	7/8	3/4	1-1/4-12	1-1/4	2.35	.751

Flare to Metric Adaptor 48F-X-MIX

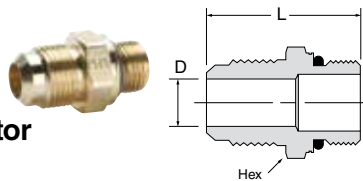

PART NUMBER	TUBE SIZE	METRIC THREAD	STRAIGHT THREAD TUBE	HEX	L	D
48F-8-MI16	1/2	M16 X 1.5	3/4-16	7/8	1.60	.35
48F-10-MI27	5/8	M27 X 2.0	7/8-14	1 1/4	1.87	.50
48F-12-MI27*	3/4	M27 X 2.0	1 1/16-14	1 1/4	1.99	.63

Note: Fluorocarbon o-ring is standard

Flare to SAE Straight Thread 485F

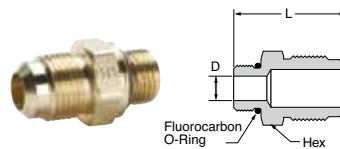

PART NO.	TUBE SIZE	STRAIGHT THREAD	STRAIGHT THREAD TUBE	HEX	L	FLOW DIA. D
485F-12-8*	3/4	3/4-16	1 1/16-14	1 1/16	1.80	.397
485F-12-12*	3/4	1 1/16-12	1 1/16-14	1 1/4	2.03	.615

*Comes standard with thread protectors.
WARNING These products can expose you to chemicals including LEAD which is known to the state of California to cause cancer and birth defects or other reproductive harm. For more information go to www.P65Warnings.ca.gov.

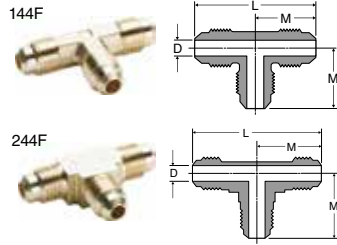

Union Tee 144F-244F

REF. SAE 010401

PART NO.	TUBE SIZE	STRAIGHT THREAD	L	M	FLOW DIA. D
144F-3	3/16	3/8-24	1.46	.73	.125
144F-4	1/4	7/16-20	1.72	.86	.189
244F-4	1/4	7/16-20	1.72	.86	.189
144F-5	5/16	1/2-20	1.82	.91	.220
144F-6	3/8	5/8-18	2.08	1.04	.282
144F-8	1/2	3/4-16	2.46	1.23	.407
144F-10	5/8	7/8-14	2.78	1.39	.501

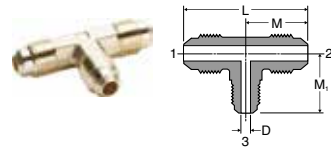

Union Tee 144F combination sizes

PART NO.	1 TUBE SIZE	2 TUBE SIZE	3 TUBE SIZE	L	M	M1	FLOW DIA. D
144F-6-6-4	3/8	3/8	1/4	2.08	1.04	.89	.189
144F-8-8-6	1/2	1/2	3/8	2.40	1.20	1.10	.282

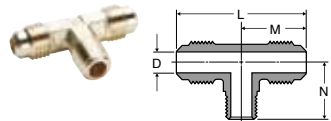

Male Branch Tee 145F

REF. SAE 010425

PART NO.	TUBE SIZE	PIPE THREAD	STRAIGHT THREAD	L	M	N	FLOW DIA. D
145F-2-2	1/8	1/8	5/16-24	1.26	.63	.69	.079
145F-4-2	1/4	1/8	7/16-20	1.58	.79	.76	.189
145F-4-4	1/4	1/4	7/16-20	1.78	.89	.92	.189
145F-5-4	5/16	1/4	1/2-20	1.90	.95	.96	.220
145F-6-4	3/8	1/4	5/8-18	1.96	.98	1.05	.282
145F-6-6	3/8	3/8	5/8-18	2.00	1.00	.98	.282
145F-6-8	3/8	1/2	5/8-18	2.28	1.14	1.26	.282
145F-8-6	1/2	3/8	3/4-16	2.40	1.20	1.10	.407
145F-8-8	1/2	1/2	3/4-16	2.46	1.23	1.36	.407
145F-10-8	5/8	1/2	7/8-14	2.78	1.39	1.36	.501

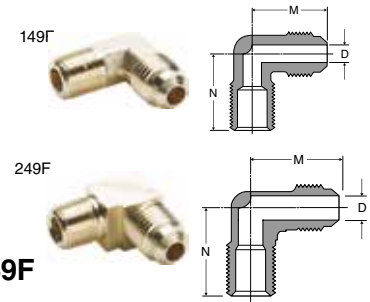

Male Elbow 149F-249F

REF. SAE 010202

PART NO.	TUBE SIZE	PIPE THREAD	STRAIGHT THREAD	M	N	FLOW DIA. D
149F-2-2	1/8	1/8	5/16-24	.63	.69	.079
149F-3-2	3/16	1/8	3/8-24	.75	.75	.125
249F-3-2	3/16	1/8	3/8-24	.73	.73	.125
149F-4-2	1/4	1/8	7/16-20	.79	.76	.189
249F-4-2	1/4	1/8	7/16-20	.79	.76	.189
149F-4-4	1/4	1/4	7/16-20	.89	.92	.189
249F-4-4	1/4	1/4	7/16-20	.89	.92	.189
149F-4-6	1/4	3/8	7/16-20	.92	1.01	.189
249F-4-6	1/4	3/8	7/16-20	.92	1.01	.189
149F-4-8	1/4	1/2	7/16-20	1.02	1.26	.189
149F-5-2	5/16	1/8	1/2-20	.90	.79	.220
249F-5-2	5/16	1/8	1/2-20	.89	.77	.220
149F-5-4	5/16	1/4	1/2-20	.95	.95	.220
249F-5-4	5/16	1/4	1/2-20	.95	.92	.220
149F-5-6	5/16	3/8	1/2-20	.98	1.01	.220
149F-6-2*	3/8	1/8	5/8-18	1.01	.90	.220
249F-6-2*	3/8	1/8	5/8-18	1.01	.89	.220
149F-6-4	3/8	1/4	5/8-18	1.01	1.05	.282
249F-6-4	3/8	1/4	5/8-18	.98	1.04	.282
149F-6-6	3/8	3/8	5/8-18	1.04	1.07	.282
249F-6-6	3/8	3/8	5/8-18	1.04	1.07	.282
149F-6-8	3/8	1/2	5/8-18	1.15	1.26	.282
249F-6-8	3/8	1/2	5/8-18	1.14	1.26	.282
149F-6-12*	3/8	3/4	5/8-18	1.25	1.38	.282
149F-8-4*	1/2	1/4	3/4-16	1.20	1.17	.314
149F-8-6	1/2	3/8	3/4-16	1.20	1.10	.407
249F-8-6	1/2	3/8	3/4-16	1.20	1.10	.407
149F-8-8	1/2	1/2	3/4-16	1.28	1.38	.407
249F-8-8	1/2	1/2	3/4-16	1.26	1.36	.407
149F-8-12*	1/2	3/4	3/4-16	1.38	1.38	.407
149F-10-4*	5/8	1/4	7/8-14	1.41	1.25	.314
149F-10-6*	5/8	3/8	7/8-14	1.41	1.25	.407
149F-10-8	5/8	1/2	7/8-14	1.40	1.39	.501
249F-10-8	5/8	1/2	7/8-14	1.39	1.36	.501
149F-10-12*	5/8	3/4	7/8-14	1.42	1.48	.501
149F-12-8**	3/4	1/2	1-1/16-14	1.60	1.48	.563
149F-12-12*	3/4	3/4	1-1/16-14	1.60	1.62	.626

* For these parts the pipe thread through hole is smaller than the through hole on the flare end.

*Comes standard with thread protectors

WARNING These products can expose you to chemicals including LEAD which is known to the state of California to cause cancer and birth defects or other reproductive harm. For more information go to www.P65Warnings.ca.gov.

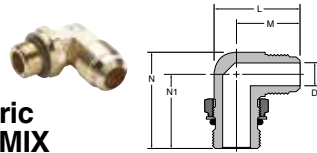

Flare Elbow to SAE Metric Straight Thread 149F-X-MIX

PART NUMBER	TUBE SIZE	METRIC THREAD	STRAIGHT THREAD TUBE	L	M	N	N1	D
149F-10-MI27	5/8	M27 X 2.0	7/8-14	1.95	1.46	2.12	1.63	.501

Note: Fluorocarbon o-ring is standard

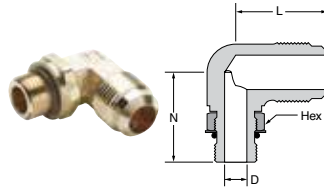

Flare Elbow to SAE Straight Thread 1495F

PART NO.	TUBE SIZE	STRAIGHT THREAD	STRAIGHT THREAD TUBE	HEX	L	N	FLOW DIA. D
1495F-12-8*	3/4	3/4-16	1 1/16-14	7/8	1.60	1.60	.398
1495F-12-12*	3/4	1-1/16-12	1 1/16-14	1 1/4	1.59	2.12	.616

Note: Fluorocarbon o-ring is standard

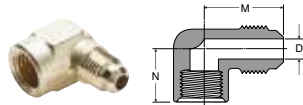

Female Elbow 150F

REF. SAE 010203

PART NO.	TUBE SIZE	PIPE THREAD	STRAIGHT THREAD	M	N	FLOW DIA. D
150F-4-2	1/4	1/8	7/16-20	.86	.50	.189
150F-4-4	1/4	1/4	7/16-20	.95	.67	.189
150F-5-4	5/16	1/4	1/2-20	1.01	.67	.220
150F-6-2	3/8	1/8	5/8-18	1.08	.48	.282
150F-6-4	3/8	1/4	5/8-18	1.07	.67	.282
150F-6-6	3/8	3/8	5/8-18	1.14	.67	.282
150F-6-8	3/8	1/2	5/8-18	1.23	.86	.282
150F-8-6	1/2	3/8	3/4-16	1.25	.69	.407
150F-8-8	1/2	1/2	3/4-16	1.36	.92	.407
150F-8-12	1/2	3/4	3/4-16	1.51	.92	.407
150F-10-8*	5/8	1/2	7/8-14	1.48	.98	.501
150F-10-12*	5/8	3/4	7/8-14	1.64	.98	.501

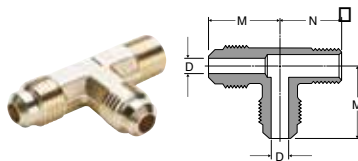

Male Run Tee 151F

REF. SAE 010424

PART NO.	TUBE SIZE	PIPE THREAD	STRAIGHT THREAD	M	N	FLOW DIA. D
151F-4-2	1/4	1/8	7/16-20	.86	.76	.189
151F-4-4	1/4	1/4	7/16-20	.89	.92	.189
151F-5-4	5/16	1/4	1/2-20	.95	.92	.220
151F-6-4	3/8	1/4	5/8-18	1.04	1.04	.282
151F-6-6	3/8	3/8	5/8-18	1.00	.98	.282
151F-6-8	3/8	1/2	5/8-18	1.16	1.26	.282
151F-8-6	1/2	3/8	3/4-16	1.20	1.10	.407
151F-8-8	1/2	1/2	3/4-16	1.23	1.36	.407
151F-10-8	5/8	1/2	7/8-14	1.39	1.36	.501

*Comes standard with thread protectors

WARNING These products can expose you to chemicals including LEAD which is known to the state of California to cause cancer and birth defects or other reproductive harm. For more information go to www.P65Warnings.ca.gov.

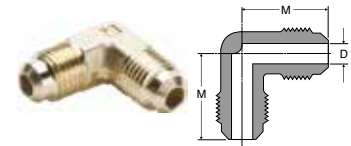

Union Elbow 155F

REF. SAE 010201

PART NO.	TUBE SIZE	STRAIGHT THREAD	M	FLOW DIA. D
155F-2	1/8	5/16-24	.64	.079
155F-3	3/16	3/8-24	.73	.125
155F-4	1/4	7/16-20	.86	.189
155F-5	5/16	1/2-20	.92	.220
155F-6	3/8	5/8-18	1.04	.282
155F-8	1/2	3/4-16	1.20	.407
155F-10	5/8	7/8-14	1.39	.501
155F-12*	3/4	1-1/16-14	1.64	.626

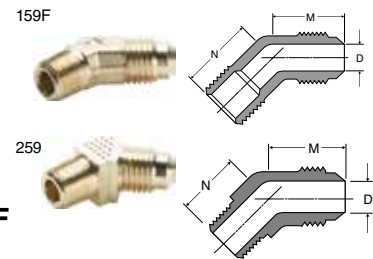

45° Elbow 159F-259F

REF. SAE 010302

PART NO.	TUBE SIZE	PIPE THREAD	STRAIGHT THREAD	M	N	FLOW DIA. D
159F-4-2	1/4	1/8	7/16-20	.78	.56	.189
259F-4-2	1/4	1/8	7/16-20	.65	.62	.189
159F-4-4	1/4	1/4	7/16-20	.75	.84	.189
259F-4-4	1/4	1/4	7/16-20	.73	.84	.189
159F-5-2	5/16	1/8	1/2-20	.76	.65	.220
159F-5-4	5/16	1/4	1/2-20	.75	.81	.220
159F-6-2*	3/8	1/8	5/8-18	.89	.67	.220
159F-6-4	3/8	1/4	5/8-18	.89	.86	.282
259F-6-4	3/8	1/4	5/8-18	.91	.86	.282
159F-6-6	3/8	3/8	5/8-18	.91	.93	.282
259F-6-6	3/8	3/8	5/8-18	.91	.93	.282
159F-8-4*	1/2	1/4	3/4-16	1.06	.95	.314
159F-8-6	1/2	3/8	3/4-16	1.06	.95	.407
259F-8-6	1/2	3/8	3/4-16	1.04	.93	.407
159F-8-8	1/2	1/2	3/4-16	1.12	1.16	.407
159F-10-6*	5/8	3/8	7/8-14	1.13	.95	.407
159F-10-8	5/8	1/2	7/8-14	1.21	1.16	.501
159F-12-8**	3/4	1/2	1-1/16-14	1.28	1.16	.560

* For these parts the pipe thread through hole is smaller than the through hole on the flare end.

45° Flare Elbow to SAE Metric Straight Thread 159F-X-MIX

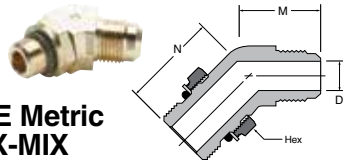

PART NUMBER	TUBE SIZE	METRIC THREAD	STRAIGHT THREAD TUBE	HEX	M	N	D
159F-8-M16	1/2	M16 X 1.5	3/4-16	22MM	1.10	1.16	.36
159F-10-M27	5/8	M27 X 2.0	7/8-14	1 1/4	1.21	1.50	.50

Note: Fluorocarbon o-ring is standard

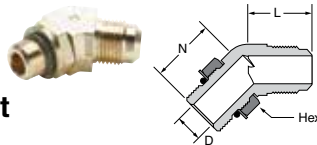

45° Flare to SAE Straight Thread 1595F

PART NO.	TUBE SIZE	STRAIGHT THREAD	STRAIGHT THREAD TUBE	HEX	L	N	FLOW DIA. D
1595F-8-8	1/2	3/4-16	3/4-16	7/8	1.00	1.16	.398
1595F-12-8*	3/4	3/4-16	1 1/16-14	7/8	1.41	1.30	.398
1595F-12-12*	3/4	1 1/16-12	1 1/16-14	1 1/4	1.41	1.45	.615

Note: Fluorocarbon o-ring is standard

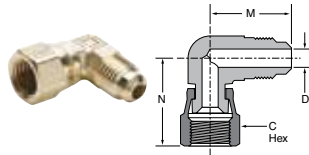

90° Swivel Elbow 166FSV

PART NO.	TUBE SIZE	STRAIGHT THREAD	C HEX	M	N	FLOW DIA. D
166FSV-4-4	1/4	7/16-20	9/16	.86	.93	.189
166FSV-6-6	3/8	5/8-18	3/4	1.04	1.12	.282
166FSV-8-8	1/2	3/4-16	7/8	1.20	1.29	.407
166FSV-10-10	5/8	7/8-14	1	1.39	1.50	.501
166FSV-12-12*	3/4	1-1/16-14	1-1/4	1.60	1.83	.626

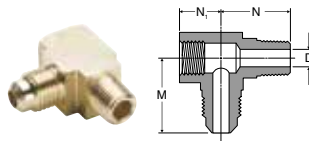

Adapter Tee 256F

PART NO.	TUBE SIZE	PIPE THREAD	STRAIGHT THREAD	M	N	N1	FLOW DIA. D
256F-4-2	1/4	1/8	7/16-20	.86	.77	.47	.220

Flared Seal Plug 639F

REF. SAE 010109

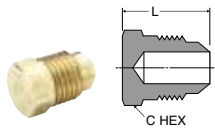

PART NO.	TUBE SIZE	STRAIGHT THREAD	C HEX	L
639F-4	1/4	7/16-20	7/16	.69
639F-5	5/16	1/2-20	1/2	.78
639F-6	3/8	5/8-18	5/8	.88
639F-8	1/2	3/4-16	3/4	1.06
639F-10	5/8	7/8-14	7/8	1.19

*Comes standard with thread protectors

†Should be used with 2GF flare gasket

WARNING These products can expose you to chemicals including LEAD which is known to the state of California to cause cancer and birth defects or other reproductive harm. For more information go to www.P65Warnings.ca.gov.

Cap Nut 640F

REF. SAE 010112

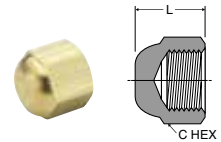

PART NO.	TUBE SIZE	STRAIGHT THREAD	C HEX	L
640F-3†	3/16	3/8-24	1/2	.47
640F-4†	1/4	7/16-20	9/16	.53
640F-5†	5/16	1/2-20	5/8	.62
640F-6†	3/8	5/8-18	3/4	.69
640F-8†	1/2	3/4-16	7/8	.84
640F-10†	5/8	7/8-14	1-1/16	.97

Flared Union—Female Flare to Female Flare 660FHD

REF. SAE 010107

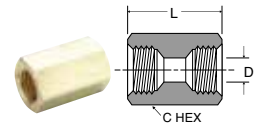

PART NO.	TUBE SIZE	STRAIGHT THREAD	C HEX	L	FLOW DIA. D
660FHD-4†	1/4	7/16-20	5/8	.98	.251
660FHD-6†	3/8	5/8-18	13/16	1.24	.376
660FHD-8†	1/2	3/4-16	15/16	1.43	.501
660FHD-10†	5/8	7/8-14	1-1/16	1.67	.626

Male Flare to Female Flare 661FHD

REF. SAE 010105

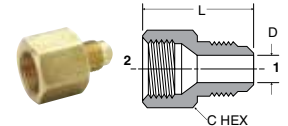

PART NO.	1 TUBE SIZE	2 TUBE SIZE	1 STRAIGHT THREAD	2 STRAIGHT THREAD	C HEX	L	FLOW DIA. D
661FHD-4-6†	1/4	3/8	7/16-20	5/8-18	13/16	1.20	.189
661FHD-4-8†	1/4	1/2	7/16-20	3/4-16	15/16	1.36	.189
661FHD-6-4†	3/8	1/4	5/8-18	7/16-20	5/8	1.10	.282
661FHD-6-8†	3/8	1/2	5/8-18	3/4-16	15/16	1.42	.282
661FHD-8-6†	1/2	3/8	3/4-16	5/8-18	13/16	1.39	.407
661FHD-8-10†	1/2	5/8	3/4-16	7/8-14	1-1/16	1.67	.407
661FHD-10-8†	5/8	1/2	7/8-14	3/4-16	15/16	1.60	.501
661FHD-10-12††	5/8	3/4	7/8-14	1-1/16-14	1-5/16	1.95	.501
661FHD-12-10††	3/4	5/8	1-1/16-14	7/8-14	1-1/16	1.86	.626

Female Flare to Male Pipe Thread 664FHD

REF. SAE 010106

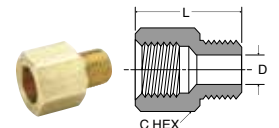

PART NO.	TUBE SIZE	PIPE THREAD	STRAIGHT THREAD	C HEX	L	FLOW DIA. D
664FHD-4-2†	1/4	1/8	7/16-20	5/8	.91	.220
664FHD-4-4†	1/4	1/4	7/16-20	5/8	1.01	.252
664FHD-6-4†	3/8	1/4	5/8-18	13/16	1.28	.345
664FHD-8-6†	1/2	3/8	3/4-16	15/16	1.31	.407



Inverted Flared Fittings

Parker's Inverted Flare Fittings offers a metal-to-metal seal that is internal to the fitting for tighter tube bends. These fittings are listed with UL and meets the functional requirements of SAE J512.

Product Features:

- All brass construction
- UL listed for flammable liquid and gas
- Meets functional requirements of SAE J512
- Steel nut for economy

Markets:

- Air Conditioning
- Marine
- Mobile
- Engines

Applications:

- Refrigerant Lines
- Brake Lines
- Fuel Lines

Compatible Tubing:

- Copper
- Brass
- Aluminum
- Welded Steel Hydraulic Tubing



Specifications:

Temperature Range: -65° to +250° F (-53.8° to 121.1° C)

Pressure Range:

TUBE SIZE	PSI	bar	TUBE SIZE	PSI	bar
1/8	2800	193.0	3/8	1000	68.9
3/16	1900	131.0	1/2	750	51.7
1/4	1400	96.5	5/8	650	44.8
5/16	1200	82.7	3/4	550	37.9

Assembly Instructions

1. Cut tubing squarely and clean to remove burrs
2. Place nut onto tube. Place threaded end of nut toward end of tube.
3. Flare tube end with flaring tool to provide 45° flare
4. On thin wall copper, welded or brazed tubing, use double flare to prevent pinch-off or cracked flares
5. Clamp tube flare between nut and nose of fitting body by screwing nut on finger tight. Tighten nut with a wrench an additional 1/4 to 1/2 turn past finger tight for a metal-to-metal seal.



WARNING These products can expose you to chemicals including LEAD which is known to the state of California to cause cancer and birth defects or other reproductive harm. For more information go to www.P65Warnings.ca.gov.

Nut 411F

REF. SAE 040110

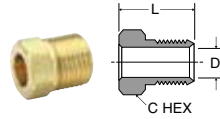

PART NO.	TUBE SIZE	STRAIGHT THREAD	C HEX	L	D
411F-2	1/8	5/16-28	5/16	.52	.133
411F-3	3/16	3/8-24	3/8	.56	.196
411F-4	1/4	7/16-24	7/16	.56	.259
411F-5	5/16	1/2-20	1/2	.62	.321
411F-6	3/8	5/8-18	5/8	.66	.384
411F-8	1/2	3/4-18	3/4	.74	.508

Female Connector 461FHD

REF. SAE 040103

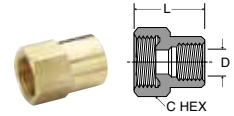

PART NO.	TUBE SIZE	PIPE THREAD	STRAIGHT THREAD	C HEX	L	FLOW DIA. D
461FHD-3-2	3/16	1/8	3/8-24	1/2	.76	.125
461FHD-4-2	1/4	1/8	7/16-24	17/32	.78	.189
461FHD-5-2	5/16	1/8	1/2-20	19/32	.79	.220
461FHD-6-4	3/8	1/4	5/8-18	3/4	1.04	.282
461FHD-8-6	1/2	3/8	3/4-18	29/32	1.10	.407

Steel Nut-Zinc 411FS

REF. SAE 040110

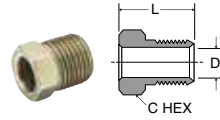

PART NO.	TUBE SIZE	STRAIGHT THREAD	C HEX	L	D
411FS-3	3/16	3/8-24	3/8	.56	.196
411FS-4	1/4	7/16-24	7/16	.56	.259
411FS-5	5/16	1/2-20	1/2	.62	.321
411FS-6	3/8	5/8-18	5/8	.66	.384
411FS-8	1/2	3/4-18	3/4	.74	.508
411FS-10	5/8	7/8-18	7/8	.80	.633
411FS-12	3/4	1-1/16-16	1-1/16	.88	.759

Male Connector 481FHD

REF. SAE 040102

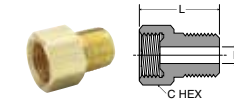

PART NO.	TUBE SIZE	PIPE THREAD	STRAIGHT THREAD	C HEX	L	FLOW DIA. D
481FHD-2-2	1/8	1/8	5/16-28	13/32	.63	.078
481FHD-3-2	3/16	1/8	3/8-24	15/32	.70	.125
481FHD-4-2	1/4	1/8	7/16-24	17/32	.74	.189
481FHD-4-4	1/4	1/4	7/16-24	9/16	.89	.189
481FHD-5-2	5/16	1/8	1/2-20	19/32	.79	.220
481FHD-5-4	5/16	1/4	1/2-20	19/32	.98	.220
481FHD-6-2	3/8	1/8	5/8-18	3/4	.89	.220
481FHD-6-4	3/8	1/4	5/8-18	3/4	1.03	.282
481FHD-6-6	3/8	3/8	5/8-18	3/4	1.03	.282
481FHD-8-4	1/2	1/4	3/4-18	29/32	1.07	.346
481FHD-8-6	1/2	3/8	3/4-18	29/32	1.07	.407
481FHD-8-8	1/2	1/2	3/4-18	29/32	1.26	.407
481FHD-10-8	5/8	1/2	7/8-18	1-1/16	1.32	.533
481FHD-12-12	3/4	3/4	1-1/16-16	1 1/4	1.38	.626

Piloted Nut 411FF for Single Flared Tubing

REF. SAE 040110

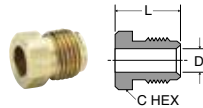

PART NO.	TUBE SIZE	STRAIGHT THREAD	C HEX	L	D
411FF-2	1/8	5/16-28	5/16	.52	.133
411FF-3	3/16	3/8-24	3/8	.56	.196
411FF-4	1/4	7/16-24	7/16	.56	.259
411FF-5	5/16	1/2-20	1/2	.62	.321
411FF-6	3/8	5/8-18	5/8	.66	.384
411FF-8	1/2	3/4-18	3/4	.74	.508

Union Tee 2441FHD

REF. SAE 040401

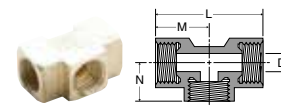

PART NO.	TUBE SIZE	STRAIGHT THREAD	L	M	N	FLOW DIA. D
2441FHD-3	3/16	3/8-24	1.10	.55	.39	.125
2441FHD-4	1/4	7/16-24	1.13	.56	.42	.189
2441FHD-5	5/16	1/2-20	1.26	.63	.45	.220
2441FHD-6	3/8	5/8-18	1.48	.74	.56	.282
2441FHD-8*	1/2	3/4-18	1.76	.88	.67	.407

*Does not meet SAE or UL.

Union 421FHD

REF. SAE 040101

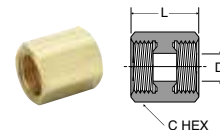

PART NO.	TUBE SIZE	STRAIGHT THREAD	C HEX	L	D
421FHD-2	1/8	5/16-28	13/32	.60	.078
421FHD-3	3/16	3/8-24	15/32	.63	.125
421FHD-4	1/4	7/16-24	17/32	.63	.189
421FHD-5	5/16	1/2-20	19/32	.71	.220
421FHD-6	3/8	5/8-18	3/4	.81	.282
421FHD-8	1/2	3/4-18	29/32	.92	.407

WARNING These products can expose you to chemicals including LEAD which is known to the state of California to cause cancer and birth defects or other reproductive harm. For more information go to www.P65Warnings.ca.gov.

Male Branch Tee 245IFHD

REF. SAE 040425

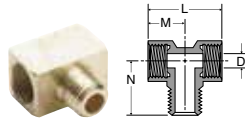

PART NO.	TUBE SIZE	PIPE THREAD	STRAIGHT THREAD	L	M	N	FLOW DIA. D
245IFHD-4-2	1/4	1/8	7/16-24	.85	.43	.64	.189
245IFHD-6-4	3/8	1/4	5/8-18	1.17	.58	.94	.282

Female Elbow 250IFHD

REF. SAE 040203



PART NO.	TUBE SIZE	PIPE THREAD	STRAIGHT THREAD	M	N	FLOW DIA. D
250IFHD-3-2	3/16	1/8	3/8-24	.50	.49	.125
250IFHD-4-2	1/4	1/8	7/16-24	.53	.53	.189
250IFHD-5-2	5/16	1/8	1/2-20	.59	.59	.220
250IFHD-6-4	3/8	1/4	5/8-18	.67	.68	.282

Male Elbow 249IFHD–249IF

REF. SAE 040202

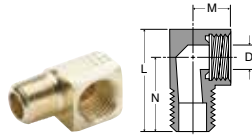

PART NO.	TUBE SIZE	PIPE THREAD	STRAIGHT THREAD	L	M	N	FLOW DIA. D
249IFHD-2-2	1/8	1/8	5/16-28	.79	.27	.58	.078
249IFHD-3-2	3/16	1/8	3/8-24	.85	.27	.61	.125
249IFHD-4-2†	1/4	1/8	7/16-24	.92	.33	.65	.189
249IFHD-4-4	1/4	1/4	7/16-24	1.10	.28	.82	.189
249IFHD-5-4	5/16	1/4	1/2-20	1.16	.45	.86	.220
249IFHD-6-2†	3/8	1/8	5/8-18	1.13	.53	.76	.220
249IF-6-4†	3/8	1/4	5/8-18	1.26	.45	.92	.282
249IFHD-6-4	3/8	1/4	5/8-18	1.32	.53	.95	.282
249IFHD-6-6	3/8	3/8	5/8-18	1.32	.50	.94	.282
249IFHD-8-4†	1/2	1/4	3/4-18	1.48	.59	1.02	.407
249IF-8-6†	1/2	3/8	3/4-18	1.42	.53	.99	.407
249IFHD-8-6†	1/2	3/8	3/4-18	1.48	.59	1.02	.407
249IFHD-8-8	1/2	1/2	3/4-18	1.67	.66	1.22	.407
249IFHD-10-6†	5/8	3/8	7/8-18	1.62	.67	1.09	.531
249IFHD-10-8†	5/8	1/2	7/8-18	1.82	.67	1.29	.533

†Light Duty Series

+For these parts the pipe thread through hole is smaller than the through hole on the flare end.

Male Run Tee 251IFHD

REF. SAE 040424

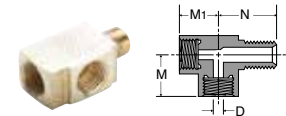

PART NO.	TUBE SIZE	PIPE THREAD	STRAIGHT THREAD	M	M1	N	FLOW DIA. D
251IFHD-3-2	3/16	1/8	3/8-24	.39	.53	.72	.125
251IFHD-5-2	5/16	1/8	1/2-20	.45	.62	.85	.220
251IFHD-6-4	3/8	1/4	5/8-18	.56	.75	1.08	.282

Female Branch Tee 252IFHD

REF. SAE 040427

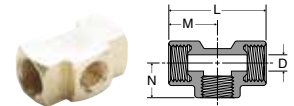

PART NO.	TUBE SIZE	PIPE THREAD	STRAIGHT THREAD	L	M	N	FLOW DIA. D
252IFHD-5-2	5/16	1/8	1/2-20	1.26	.63	.45	.220
252IFHD-6-4	3/8	1/4	5/8-18	1.48	.74	.56	.282

Union Elbow 255IFHD

PART NO.	TUBE SIZE	STRAIGHT THREAD	M	FLOW DIA. D
255IFHD-4*	1/4	7/16-24	.55	.189

*Does not meet SAE or UL.

45° Elbow 259IFHD

REF. SAE 040302

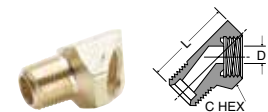

PART NO.	TUBE SIZE	PIPE THREAD	STRAIGHT THREAD	C HEX	L	FLOW DIA. D
259IFHD-3-2	3/16	1/8	3/8-24	17/32	.88	.125
259IFHD-4-2	1/4	1/8	7/16-24	9/16	.94	.189
259IFHD-5-2	5/16	1/8	1/2-20	5/8	1.00	.220
259IFHD-5-4	5/16	1/4	1/2-20	5/8	1.16	.220
259IFHD-6-4*	3/8	1/4	5/8-18	13/16	1.34	.282
259IFHD-8-6	1/2	3/8	3/4-18	7/8	1.44	.407
259IFHD-10-8	5/8	1/2	7/8-18	1-1/16	1.75	.533

*Does not meet SAE or UL.

WARNING These products can expose you to chemicals including LEAD which is known to the state of California to cause cancer and birth defects or other reproductive harm. For more information go to www.P65Warnings.ca.gov.





Access Valves

Parker's Access Valves are designed to offer convenient, low cost access ports for refrigeration service. Access valves may be installed in any position on either high or low side for quick testing, pressure checking, purging or charging.

Product Features:

- All brass construction
- 1/4" SAE male flare access ports
- Finger tight quick seal caps
- Access valves with pipe connections have internal ODS solder cups

Markets:

- Refrigeration
- Air Conditioning

Applications:

- Pressure Testing
- Purging
- Charging Refrigeration Lines

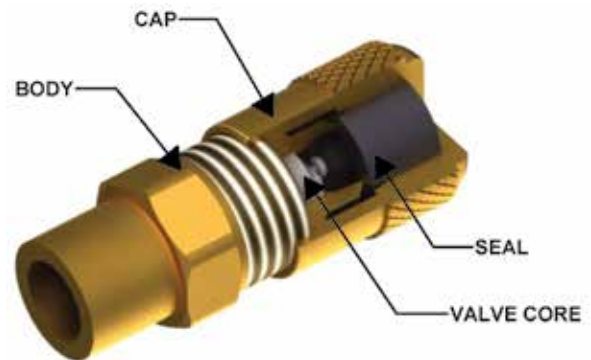

Specifications:

Pressure Range Up to 500 PSI (34.3 bar)

Temperature Range -20° to +220° F (-28.8° to +104.4° C)

Compatible Tubing:

- Copper

WARNING These products can expose you to chemicals including LEAD which is known to the state of California to cause cancer and birth defects or other reproductive harm. For more information go to www.P65Warnings.ca.gov.



Extended Copper Tube AVUSE



PART NO.	CONNECTION SIZE
AVUSE-2	1/8" O.D. TUBE
AVUSE-3	3/16" O.D. TUBE
AVUSE-4	1/4" O.D. TUBE
AVUSE-6	3/8" O.D. TUBE
AVUSE-8	1/2" O.D. TUBE

Product comes with valve core loose and should be torqued after brazing to ARI 720 standard.

Solder Tee AVTS



PART NO.	CONNECTION SIZE
AVTS-4	1/4" O.D. TUBE OR 3/8" SOLDER FITTING/SWAGED TUBE
AVTS-6	3/8" O.D. TUBE OR 1/2" SOLDER FITTING/SWAGED TUBE
AVTS-8	1/2" O.D. TUBE

Product comes with valve core loose and should be torqued after brazing to ARI 720 standard.

Full Union AVU2



PART NO.	CONNECTION SIZE
AVU2-4	1/4" O.D. FLARE TUBE WITH FORGED FLARE NUT

Bulkhead Union AVU2BH



PART NO.	CONNECTION SIZE
AVU2BH-4	1/4" BULKHEAD ACCESS X 1/4" SAE WITH FORGED NUT

Bulkhead Solder Union AVUS3BH



PART NO.	CONNECTION SIZE
AVUS3BH-4	1/4" BULKHEAD ACCESS X 3 WAY ODS

Product comes with valve core loose and should be torqued after brazing to ARI 720 standard.

Male Connector AVU1



PART NO.	CONNECTION SIZE
AVU1-2	1/8" MALE PIPE OR 1/4" O.D. SOLDER
AVU1-4	1/4" MALE PIPE OR 5/16" O.D. SOLDER

Product comes with valve core loose and should be torqued after brazing to ARI 720 standard.

Access Valve Assembly AVUIFI



PART NO.	CONNECTION SIZE
AVUIFI-4	7/16-20 SAE STRAIGHT THREAD O-RING PORT

Note: Standard o-ring is neoprene. Consult Brass Products Division for optional o-rings

Forged Male Elbow AVE1



PART NO.	CONNECTION SIZE
AVE1-2	1/8" MALE PIPE OR 1/4" O.D. SOLDER

Product comes with valve core loose and should be torqued after brazing to ARI 720 standard.

Forged Male Run Tee AVT3



PART NO.	CONNECTION SIZE
AVT3-2	1/8" MALE PIPE OR 1/4" O.D. SOLDER ON RUN X 1/4" ACCESS ON RUN AND BRANCH WITH ONE CORE AND CAP
AVT3-4	1/4" MALE PIPE OR 5/16" O.D. SOLDER ON RUN X 1/4" ACCESS ON RUN AND BRANCH WITH ONE CORE AND CAP

Product comes with valve core loose and should be torqued after brazing to ARI 720 standard.

Forged Male Cross AVC1



PART NO.	CONNECTION SIZE
AVC1-4	1/4" MALE PIPE OR 5/16" O.D. SOLDER X 1/4" ACCESS ON ALL FLARE ENDS WITH ONE CORE AND CAP

Product comes with valve core loose and should be torqued after brazing to ARI 720 standard.

Female Connector AVUR3



PART NO.	CONNECTION SIZE
AVUR3-4	1/4" FEMALE FLARE WITH COPPER GASKET

WARNING These products can expose you to chemicals including LEAD which is known to the state of California to cause cancer and birth defects or other reproductive harm. For more information go to www.P65Warnings.ca.gov.



3 Way Solder Connector AVUS3



PART NO.	CONNECTION SIZE
AVUS3-40	FOR 3/16" O.D. TUBE OR 1/4" AND 3/8" SOLDER FITTING/SWAGED TUBE

Product comes with valve core loose and should be torqued after brazing to ARI 720 standard.

Straight Solder Connector AVUS



PART NO.	CONNECTION SIZE
AVUS-42	1/8" O.D. TUBE OR 1/4" SOLDER FITTING/SWAGED TUBE
AVUS-43	3/16" O.D. TUBE OR 1/4" SOLDER FITTING/SWAGED TUBE
AVUS-44	1/4" O.D. TUBE OR 3/8" SOLDER FITTING/SWAGED TUBE
AVUS-46	3/8" O.D. TUBE OR 1/2" SOLDER FITTING/SWAGED TUBE

Product comes with valve core loose and should be torqued after brazing to ARI 720 standard.

Swivel Connector AVUS4D



PART NO.	CONNECTION SIZE
AVUS4D-4	1/4" FORGED FEMALE FLARE SWIVEL NUT WITH DEPRESSOR

Forged Female Run Swivel Tee AVTS4



PART NO.	CONNECTION SIZE
AVTS4-4	1/4" FEMALE FLARE SWIVEL X 1/4" ACCESS ON BOTH RUN AND BRANCH
AVTS4D-4	1/4" FEMALE FLARE SWIVEL ON RUN WITH DEPRESSOR X 1/4" ACCESS ON BOTH RUN AND BRANCH

Forged Female Branch Tee AVTS6



PART NO.	CONNECTION SIZE
AVTS6-4	1/4" FEMALE FLARE SWIVEL X 1/4" ACCESS ON BOTH ENDS
AVTS6D-4	1/4" FEMALE FLARE SWIVEL ON BRANCH WITH DEPRESSOR X 1/4" ACCESS ON BOTH ENDS

Quick Seal Caps 640QSF



PART NO.	CONNECTION SIZE
640QSF-4	1/4" SAE SEAL CAP WITH SEAL GASKET
640QSF-6	3/8" SAE SEAL CAP WITH SEAL GASKET

Quick Seal Cap with Core Remover 640QSFCR



PART NO.	CONNECTION SIZE
640QSFCR-4	1/4" SAE SEAL CAP CORE REMOVER WITH INTERNAL SEAL GASKET

Core Remover CR



PART NO.	CONNECTION SIZE
CR-001	STANDARD CORE REMOVER

Valve Cores VC



PART NO.	CONNECTION SIZE
VC-001	REPLACEMENT VALVE CORES FOR ALL 1/4" ACCESS VALVES

Refrigerant adapter 88AC



PART NO.	CONNECTION SIZE
88AC-8-2	1/8" MALE PIPE TO SAE J2197 ACME THREADED MALE CONNECTOR

Refrigerant adapter 880AC



PART NO.	CONNECTION SIZE
880AC-8-4	1/4" FEMALE SAE FLARE TO SAE J2197 ACME THREADED MALE CONNECTOR

Refrigerant adapter 881AC



PART NO.	CONNECTION SIZE
881AC-8-4	1/4" SAE MALE FLARE TO SAE J2197 ACME THREADED FEMALE CONNECTOR

WARNING These products can expose you to chemicals including LEAD which is known to the state of California to cause cancer and birth defects or other reproductive harm. For more information go to www.P65Warnings.ca.gov.



Industrial Barbed Fittings

Dubl-Barb[®] Fittings

Hose Barb Fittings



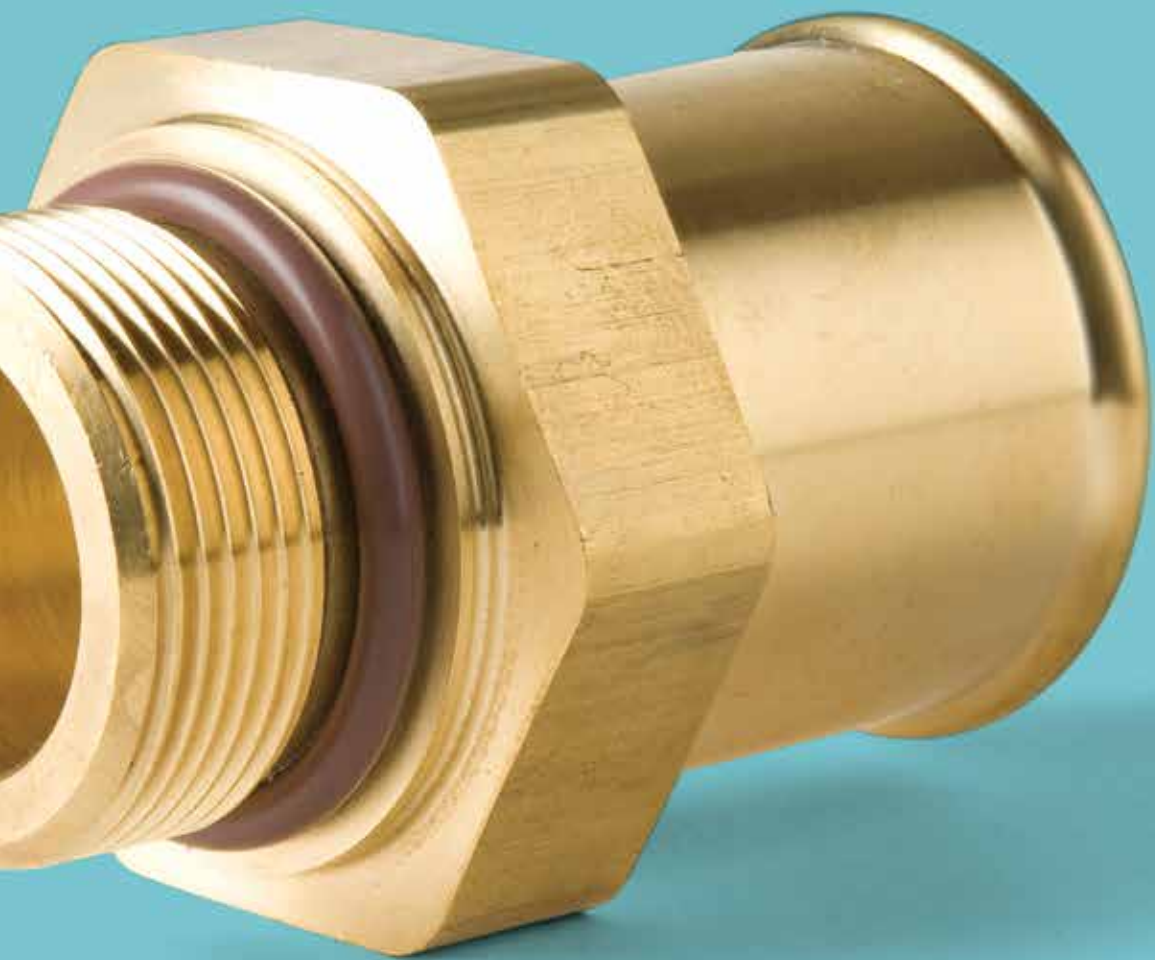

Barb to Male NPT	28 Male Connector  p. 16, 17	228 Gauge Tee  p. 17	229 Male Elbow  p. 17	231 Run Tee  p. 18	232 Branch Tee  p. 18	68HB Male Connector  p. 110
	125HB Male Connector  p. 110	125HBL Male Connector  p. 110	125HBLSV Swivel Connector  p. 111	127HB Ball-End Adapter  p. 111	129HB Male Elbow  p. 111	139HB 45° Male Elbow  p. 112
179HB 45° Male Elbow  p. 112	269HB Male Elbow  p. 113	279HB 45° Male Elbow  p. 113	Barb to Straight Thread	27 Male Connector  p. 16	685HB Male Connector  p. 110	1295HB Male Elbow  p. 111
1695HB Male Elbow  p. 112	1725HB Tee  p. 112	1795HB 45° Male Elbow  p. 112		Barb to Metric Straight Thread	68HB-X-MIX Male Connector  p. 110	169HB-X-MIX Male Elbow  p. 112
Barb to Female NPT	26 Female Connector  p. 16	230 Female Elbow  p. 18	237 Female Tee  p. 18		Barb to Barb	22 Union  p. 16
	126HBL Female Connector  p. 111	224 Union Tee  p. 17		Bulkhead Union		225 Union Elbow  p. 17
224 Union Tee  p. 17		225 Union Elbow  p. 17			22BH Bulkhead Union  p. 16	22CABH Bulkhead Union  p. 16
122HBL Union  p. 110		128HBLSV Female Ball-End  p. 111		22CA Mixed Union  p. 16		
122HBL Union  p. 110		128HBLSV Female Ball-End  p. 111		220 Adapter Tee  p. 17		233 Mixed Tee  p. 18
146HBLFSV 45° Female Flare  p. 112		Adapters		238 Solder Connector  p. 18		
Metric Hose to BSPT	0123 Male Connector  p. 113	Auxiliary Component		20 Plug  p. 16	0136 Metric Hose to BSPT  p. 114	0931 Metric Hose to BSPP  p. 114
	97HC Clamp  p. 110		0191 Metric Hose to BSPP  p. 114			

WARNING These products can expose you to chemicals including NICKEL or LEAD, which are known to the state of California to cause cancer, and LEAD which is known to cause birth defects or other reproductive harm. For more information go to www.P65Warnings.ca.gov.

Dubl-Barb® Fittings



Parker's Dubl-Barb Fittings are an economical one piece, push-on brass barbed fitting that does not require any type of clamp. These fittings are a quick way to connect polyethylene tubing.

Product Features:

- Compact
- One piece
- No clamp required
- Good vibration resistance

Markets:

- Pneumatic
- Environmental control

Applications:

- Pneumatic Systems
- Climate Control
- Humidifiers
- Filters

Compatible Tubing:

- Polyethylene



Specifications:

Pressure Range:

TUBE SIZE	PSI	bar	TUBE SIZE	PSI	bar
5/32	150	10.3	3/8	150	10.3
1/4	150	10.3	1/2	100	6.8

Temperature Range:

TUBE SIZE	TEMPERATURE IN FAHRENHEIT	TEMPERATURE IN CELSIUS
5/32	-65° to +90° F	-53.8° to +32.2° C
1/4	-65° to +90° F	-53.8° to +32.2° C
3/8	-65° to +90° F	-53.8° to +32.2° C
1/2	-65° to +75° F	-53.8° to +23.8° C

Assembly Instructions

Cut tube squarely and simply push tube over the two barbs



WARNING These products can expose you to chemicals including LEAD which is known to the state of California to cause cancer and birth defects or other reproductive harm. For more information go to www.P65Warnings.ca.gov.



Plug 20

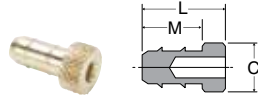

PART NO.	TUBE O.D.	TUBE I.D.	C DIA.	L	M
20-4	1/4	.170	.32	.56	.41
20-6	3/8	.250	.390	.68	.44
20-8	1/2	.377	.577	.81	.56

Plug Adapter 20

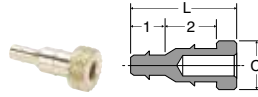

PART NO.	TUBE O.D. 1	TUBE I.D. 1	TUBE O.D. 2	TUBE I.D. 2	C DIA.	L
20-4-5/32	5/32	.096	1/4	.170	.32	.65

Union 22

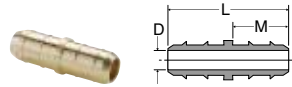

PART NO.	TUBE O.D.	TUBE I.D.	L	M	FLOW DIA. D
22-5/32	5/32X5/32	.096X.096	.59	.28	.062
22-4	1/4X1/4	.170X.170	.84	.41	.120
22-6	3/8X3/8	.250X.250	.94	.44	.187
22-8	1/2X1/2	.375X.375	1.19	.56	.312

Union Reducer 22

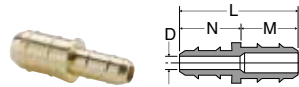

PART NO.	TUBE O.D.	TUBE I.D.	L	M	N	FLOW DIA. D
22-4-5/32	1/4X5/32	.170X.096	.72	.41	.28	.062
22-4-6	1/4X3/8	.170X.250	.88	.44	.41	.120
22-4-8	1/4X1/2	.170X.375	1.06	.56	.41	.120
22-6-8	3/8X1/2	.250X.375	1.06	.56	.44	.187

Bulkhead Union 22BH

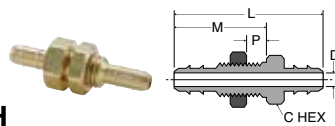

PART NO.	TUBE O.D.	TUBE I.D.	ST. THD.	C HEX	P MAX.	L	M	FLOW DIA. D	BLKHD HOLE DIA.
22BH-4-4	1/4	.170	5/16-24	7/16	.219	1.38	.78	.120	5/16
22BH-6-6	3/8	.250	3/8-24	7/16	.375	1.63	1.00	.187	3/8

Union 22CA

Tube to Compress-Align

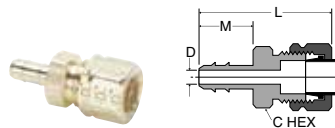

PART NO.	TUBE O.D.	TUBE I.D.	CA TUBE	C HEX	L	M	FLOW DIA. D
22CA-4-4	1/4	.170	1/4	7/16	1.15	.41	.120

Bulkhead Union 22CABH

Tube to Compress-Align

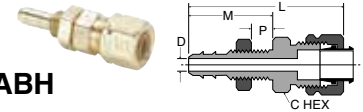

PART NO.	TUBE O.D.	TUBE I.D.	CA TUBE	ST. THD.	C HEX	P MAX	L	M	FLW DIA. D	BKHD HOLE DIA.
22CABH-4-4	1/4	.170	1/4	5/16-24	7/16	.219	1.53	.78	.120	5/16
22CABH-6-6	3/8	.250	3/8	3/8-24	9/16	.375	1.87	1.00	.187	3/8

Female Connector 26

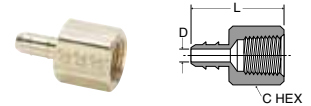

PART NO.	TUBE O.D.	TUBE I.D.	PIPE THREAD	C HEX	L	FLOW DIA. D
26-5/32-2	5/32	.096	1/8	1/2	.79	.062
26-4-2	1/4	.170	1/8	1/2	.91	.120
26-6-2	3/8	.250	1/8	1/2	.93	.187
26-6-4	3/8	.250	1/4	11/16	1.06	.187

Male Connector 27

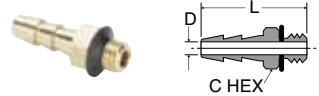

PART NO.	TUBE O.D.	TUBE I.D.	STRAIGHT THREAD	C HEX	L	FLOW DIA. D
27-1*	1/8	.062	10-32	1/4	.61	.052
27-2*	1/4	.125	10-32	1/4	.74	.093

*For vinyl tubing only.

Barb-to-Pipe Adapter 28

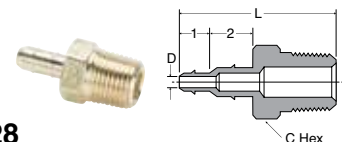

PART NO.	TUBE O.D. 1	TUBE I.D. 1	TUBE O.D. 2	TUBE I.D. 2	PIPE THD.	C HEX	L	FLOW DIA. D
28-4-5/32-2	5/32	.096	1/4	.170	1/8	7/16	1.07	.062

WARNING These products can expose you to chemicals including LEAD which is known to the state of California to cause cancer and birth defects or other reproductive harm. For more information go to www.P65Warnings.ca.gov.

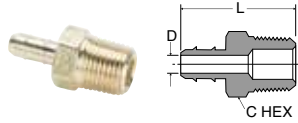

Male Connector 28

PART NO.	TUBE O.D.	TUBE I.D.	PIPE THREAD	C HEX	L	FLOW DIA. D
28-5/32-2	5/32	.096	1/8	7/16	.84	.062
28-4-1	1/4	.170	1/16	3/8	.93	.120
28-4-2	1/4	.170	1/8	7/16	.97	.120
28-4-4	1/4	.170	1/4	9/16	1.09	.120
28-4-10X32*	1/4	.170	10-32	1/4	.71	.093
28-6-2	3/8	.250	1/8	7/16	1.00	.187
28-6-4	3/8	.250	1/4	9/16	1.13	.187
28-8-4	1/2	.375	1/4	9/16	1.25	.312
28-8-6	1/2	.375	3/8	11/16	1.28	.312
28-8-8	1/2	.375	1/2	7/8	1.44	.312

*Straight thread

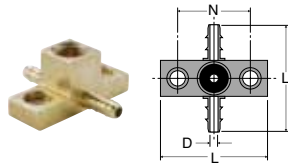

Adapter Tee 220

PART NO.	TUBE O.D.	TUBE I.D.	PIPE THREAD	L	N	FLOW DIA. D
220-4-2	1/4	.170	1/8	1.50	1.00	.120

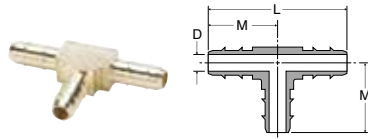

Union Tee 224

PART NO.	TUBE O.D.	TUBE I.D.	L	M	FLOW DIA. D
224-5/32	5/32	.096	1.00	.50	.062
224-4	1/4	.170	1.25	.63	.120
224-6	3/8	.250	1.38	.69	.187
224-8	1/2	.375	1.63	.81	.312

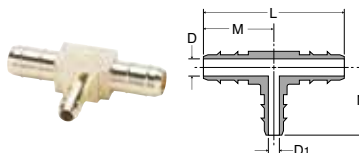

Union Tee 224 Combination Sizes

PART NO.	TUBE O.D.	TUBE I.D.	L	M	N	FLOW DIA. D	FLOW DIA. D1
224-4-4-5/32	1/4X5/32	.170X.096	1.25	.63	.50	.120	.062
224-6-6-5/32	3/8X5/32	.250X.096	1.38	.69	.50	.187	.062
224-6-6-4	3/8X1/4	.250X.170	1.38	.69	.62	.187	.120
224-8-8-4	1/2X1/4	.375X.170	1.62	.81	.65	.312	.120
224-8-8-6	1/2X3/8	.375X.250	1.62	.81	.69	.312	.187

Union Elbow 225

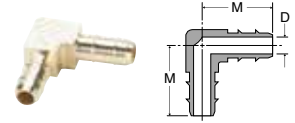

PART NO.	TUBE O.D.	TUBE I.D.	M	FLOW DIA. D
225-5/32	5/32	.096	.50	.062
225-4-4	1/4	.170	.63	.120
225-6-6	3/8	.250	.63	.187
225-8-8	1/2	.375	.81	.312

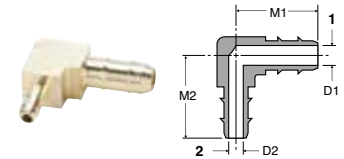

Union Elbow 225 Combination Size

PART NO.	TUBE O.D. 1	TUBE O.D. 2	TUBE I.D. 1	TUBE I.D. 2	M1	M2	FLOW DIA. D1	FLOW DIA. D2
225-4-5/32	1/4	5/32	.170	.096	.63	.50	.120	.062

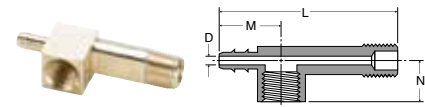

Gauge Tee 228

PART NO.	TUBE O.D.	TUBE I.D.	PIPE THREAD	L	M	N	FLOW DIA. D
228-4-2	1/4	.170	1/8	1.91	.66	.44	.120

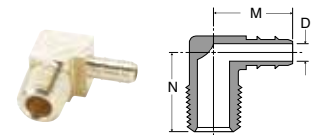

Male Elbow 229

PART NO.	TUBE O.D.	TUBE I.D.	PIPE THREAD	M	N	FLOW DIA. D
229-5/32-2	5/32	.096	1/8	.56	.63	.062
229-4-1	1/4	.170	1/16	.62	.60	.120
229-4-2	1/4	.170	1/8	.69	.63	.120
229-4-4	1/4	.170	1/4	.72	.72	.120
229-6-2	3/8	.250	1/8	.69	.69	.187
229-6-4	3/8	.250	1/4	.75	.75	.187
229-8-4	1/2	.375	1/4	.94	.74	.312
229-8-6	1/2	.375	3/8	.94	.81	.312

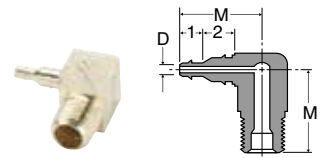

90° Elbow Barb Adapter 229

PART NO.	TUBE O.D. 1	TUBE I.D. 1	TUBE O.D. 2	TUBE I.D. 2	PIPE THREAD	M	FLOW DIA. D
229-4-5/32-2	5/32	.096	1/4	.170	1/8	.78	.062

WARNING These products can expose you to chemicals including LEAD which is known to the state of California to cause cancer and birth defects or other reproductive harm. For more information go to www.P65Warnings.ca.gov.

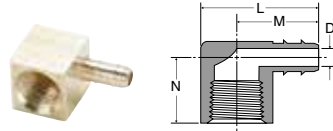

Female Elbow 230

PART NO.	TUBE O.D.	TUBE I.D.	PIPE THREAD	L	M	N	FLOW DIA. D
230-4-2	1/4	.170	1/8	.91	.66	.44	.120
230-6-4	3/8	.250	1/4	1.12	.78	.63	.187

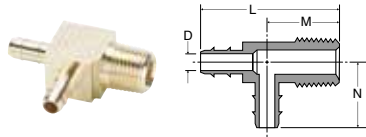

Male Run Tee 231

PART NO.	TUBE O.D.	TUBE I.D.	PIPE THREAD	L	M	N	FLOW DIA. D
231-4-2	1/4	.170	1/8	1.28	.66	.69	.120
231-6-2	3/8	.250	1/8	1.38	.69	.69	.187
231-6-4	3/8	.250	1/4	1.44	.75	.75	.187

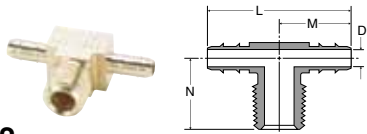

Male Branch Tee 232

PART NO.	TUBE O.D.	TUBE I.D.	PIPE THREAD	L	M	N	FLOW DIA. D
232-4-1	1/4	.170	1/16	1.33	.66	.65	.120
232-4-2	1/4	.170	1/8	1.38	.69	.66	.120
232-6-2	3/8	.250	1/8	1.38	.69	.69	.187
232-6-4	3/8	.250	1/4	1.50	.75	.75	.187

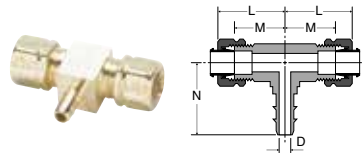

Tee 233

PART NO.	TUBE O.D.	TUBE I.D.	COMB. TUBE	L	M	N	FLOW DIA. D
233-4-4-4	1/4	.170	1/4	.73	.53	.74	.120
233-6-6-4	1/4	.170	3/8	.87	.59	.80	.120

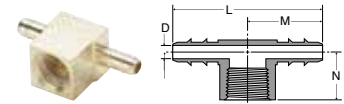

Female Branch Tee 237

PART NO.	TUBE O.D.	TUBE I.D.	PIPE THREAD	L	M	N	FLOW DIA. D
237-5/32-2	5/32	.096	1/8	1.06	.53	.44	.062
237-4-2	1/4	.170	1/8	1.34	.67	.49	.120

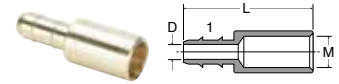

Solder Connector 238

PART NO.	TUBE O.D. 1	TUBE I.D. 1	L	M	FLOW DIA. D
238-4-4	1/4	.170	.91	.25	.120

WARNING These products can expose you to chemicals including LEAD which is known to the state of California to cause cancer and birth defects or other reproductive harm. For more information go to www.P65Warnings.ca.gov.

Hose Barb Fittings



Parker's Hose Barb Fittings are an economical choice for general purpose fluid handling and pneumatics. Manufactured in both regular hose barb and beaded hose barb styles. Fittings are intended for use with 97HC hose clamps, similar type clamp or a crimped ferrule.

Product Features:

- All brass construction
- Fluorocarbon O-rings
- NPTF, SAE straight thread, metric thread ends
- Reusable
- Clamp required

Applications:

- Air Lines
- Water Line
- Cooling Lines

Compatible Tubing:

- Rubber Hose
- GPH Hose

Markets:

- Industrial
- Construction
- Heavy duty truck
- Mobile

Specifications:

Pressure Range Up to 150 PSI (10.3 bar)

Temperature Range -40° to +160° F (-40° to +71.1° C)



Assembly Instructions

1. Cut hose cleanly and squarely to length.
2. Slide clamp on hose.
3. Lubricate hose. Push hose on fitting until bottomed against stop ring or hex.
4. Position hose clamp as shown and secure with a screwdriver or wrench. Maintain "A" dimension for proper clamp positioning.



HOSE SIZE	HOSE CLAMP	A
3/16	97 HC-3	1/4
1/4	97 HC-3	1/4
5/16	97 HC-6	1/4
3/8	97 HC-6	1/8
1/2	97 HC-8	1/8
5/8	97 HC-12	1/8
3/4	97 HC-12	1/8

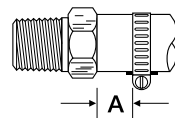

WARNING These products can expose you to chemicals including NICKEL or LEAD, which are known to the state of California to cause cancer, and LEAD which is known to cause birth defects or other reproductive harm. For more information go to www.P65Warnings.ca.gov.

Beaded Hose Barb to Male Pipe 68HB

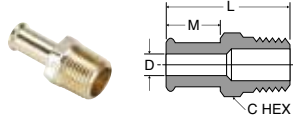

PART NO.	I.D. HOSE SIZE	PIPE THREAD	C HEX	L	M	FLOW DIA. D
68HB-6-6	3/8	3/8	11/16	1.53	.78	.281
68HB-8-4	1/2	1/4	5/8	1.56	.78	.375
68HB-8-6	1/2	3/8	11/16	1.53	.78	.406
68HB-8-8	1/2	1/2	7/8	1.84	.78	.406
68HB-10-6	5/8	3/8	3/4	1.62	.88	.501
68HB-10-8	5/8	1/2	7/8	1.92	.88	.501
68HB-12-8	3/4	1/2	7/8	1.98	.88	.564
68HB-12-12	3/4	3/4	1 1/16	2.04	.97	.625
68HB-16-12	1	3/4	1 1/8	2.12	1.00	.750
68HB-16-16	1	1	1.38	2.31	1.00	.812

Beaded Hose Barb to SAE Straight Thread 685HB

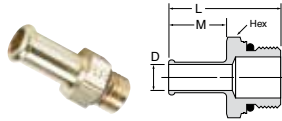

PART NO.	I.D. HOSE SIZE	STRAIGHT THREAD	C HEX	L	M	FLOW DIA. D
685HB-4-4	1/4	7/16-20	9/16	1.40	.78	.18
685HB-6-4	3/8	7/16-20	9/16	1.39	.78	.18
685HB-8-8	1/2	3/4-16	7/8	1.48	.78	.40
685HB-10-8	5/8	3/4-16	7/8	1.56	.78	.40
685HB-12-8	3/4	3/4-16	7/8	1.75	.97	.40
685HB-12-12	3/4	1 1/16-12	1 1/4	1.82	.97	.62
685HB-16-8	1	3/4-16	1 1/8	1.79	.97	.40
685HB-16-12	1	1 1/16-12	1 1/4	1.99	.97	.62

Note: Fluorocarbon o-ring is standard

Hose Barb to Metric Adaptor 68HB-X-MIX

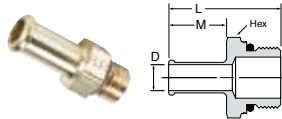

PART NUMBER	I.D. HOSE SIZE	METRIC THREAD	HEX	L	M	D
68HB-6-MI12	3/8	M12 X 1.5	11/16	1.50	.78	.24
68HB-6-MI14	3/8	M14 1.5	3/4	1.51	.78	.29
68HB-8-MI12	1/2	M12 X 1.5	11/16	1.50	.78	.24

Note: Fluorocarbon o-ring is standard

Stainless Steel Worm Drive Clamp 97HC

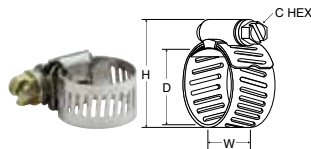

PART NO.	D MAX.	D MIN.	C HEX	H MAX.	W
97HC-3	.62	.25	.25	1.00	.31
97HC-6	.87	.38	.31	1.40	.50
97HC-8	1.00	.44	.31	1.53	.50
97HC-12	1.25	.50	.31	1.80	.50

WARNING These products can expose you to chemicals including NICKEL or LEAD, which are known to the state of California to cause cancer, and LEAD which is known to cause birth defects or other reproductive harm. For more information go to www.P65Warnings.ca.gov.

Hose Mender 122HBL

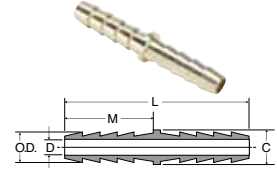

PART NO.	I.D. HOSE SIZE	C DIA.	L	M	O.D.	FLOW DIA. D
122HB-3	3/16	5/16	1.44	.69	.227	.125
122HBL-4	1/4	3/8	2.00	.97	.290	.187
122HBL-5	5/16	7/16	2.00	.97	.353	.250
122HBL-6	3/8	1/2	2.00	.97	.415	.281
122HBL-8	1/2	5/8	2.00	.97	.530	.375
122HBL-12	3/4	7/8	2.00	.97	.790	.562

Hose Barb to Male Pipe 125HB

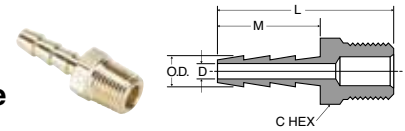

PART NO.	I.D. HOSE SIZE	PIPE THREAD	C HEX	L	M	O.D.	FLOW DIA. D
125HB-2-2	1/8	1/8	7/16	1.07	.50	.185	.093
125HB-3-2	3/16	1/8	7/16	1.25	.69	.227	.125
125HB-3-4	3/16	1/4	9/16	1.44	.69	.227	.125

Hose Barb to Male Pipe 125HBL

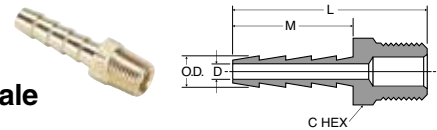

PART NO.	I.D. HOSE SIZE	PIPE THREAD	C HEX	L	M	O.D.	FLOW DIA. D
125HBL-4-2	1/4	1/8	7/16	1.54	.97	.290	.187
125HBL-4-4	1/4	1/4	9/16	1.72	.97	.290	.187
125HBL-4-6	1/4	3/8	11/16	1.77	.97	.290	.187
125HBL-5-2	5/16	1/8	7/16	1.54	.97	.353	.250
125HBL-5-4	5/16	1/4	9/16	1.72	.97	.353	.250
125HBL-5-6	5/16	3/8	11/16	1.77	.97	.353	.250
125HBL-6-2	3/8	1/8	7/16	1.54	.97	.415	.281
125HBL-6-4	3/8	1/4	9/16	1.72	.97	.415	.281
125HBL-6-6	3/8	3/8	11/16	1.77	.97	.415	.281
125HBL-6-8	3/8	1/2	7/8	1.97	.97	.415	.281
125HBL-8-4	1/2	1/4	9/16	1.72	.97	.530	.375
125HBL-8-6	1/2	3/8	11/16	1.77	.97	.530	.375
125HBL-8-8	1/2	1/2	7/8	1.97	.97	.530	.375
125HBL-8-12	1/2	3/4	1-1/16	1.98	.97	.530	.375
125HBL-10-6	5/8	3/8	11/16	1.77	.97	.645	.468
125HBL-10-8	5/8	1/2	7/8	1.97	.97	.645	.468
125HBL-10-12	5/8	3/4	1-1/16	1.98	.97	.645	.468
125HBL-12-8	3/4	1/2	7/8	1.97	.97	.790	.562
125HBL-12-12	3/4	3/4	1-1/16	1.98	.97	.790	.562
125HBL-16-12	1	3/4	1-1/16	2.18	1.17	1.02	.750
125HBL-16-16	1	1	1-3/8	2.36	1.17	1.02	.875

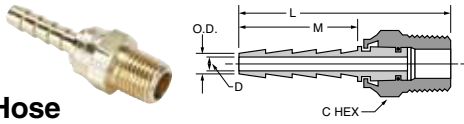

Male Swivel Hose Barb 125HBLSV

PART NO.	I.D. HOSE SIZE	PIPE THREAD	C HEX	L	M	O.D.	FLOW DIA. D
125HBLSV-4-4	1/4	1/4	11/16	2.14	.97	.290	.187
125HBLSV-6-4	3/8	1/4	11/16	2.14	.97	.415	.250
125HBLSV-6-6	3/8	3/8	11/16	2.14	.97	.415	.250
125HBLSV-8-8	1/2	1/2	7/8	2.48	.97	.530	.375

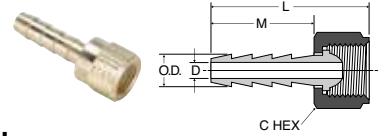

Hose Barb to Swivel Female Ball-End 128HBLSV

PART NO.	I.D. HOSE SIZE	FEMALE N.P.S.M. THREAD	C HEX	L	M	O.D.	FLOW DIA. D
128HBLSV-4-4	1/4	1/4	5/8	1.50	.97	.290	.187
128HBLSV-5-4	5/16	1/4	5/8	1.50	.97	.353	.250
128HBLSV-6-4	3/8	1/4	5/8	1.63	.97	.415	.250
128HBLSV-6-6	3/8	3/8	3/4	1.50	.97	.415	.281
128HBLSV-8-8	1/2	1/2	29/32	1.52	.97	.530	.375

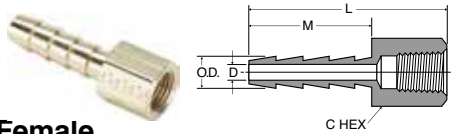

Hose Barb to Female Pipe 126HBL

PART NO.	I.D. HOSE SIZE	PIPE THREAD	C HEX	L	M	O.D.	FLOW DIA. D
126HBL-4-2	1/4	1/8	1/2	1.47	.97	.290	.187
126HBL-4-4	1/4	1/4	11/16	1.66	.97	.290	.187
126HBL-5-4	5/16	1/4	11/16	1.58	.97	.353	.250
126HBL-6-2	3/8	1/8	1/2	1.47	.97	.415	.281
126HBL-6-4	3/8	1/4	11/16	1.66	.97	.415	.281
126HBL-6-6	3/8	3/8	13/16	1.69	.97	.415	.281
126HBL-8-6	1/2	3/8	13/16	1.69	.97	.530	.375
126HBL-8-8	1/2	1/2	1	1.73	.97	.530	.375
126HBL-12-12	3/4	3/4	1-1/4	1.92	.97	.790	.562

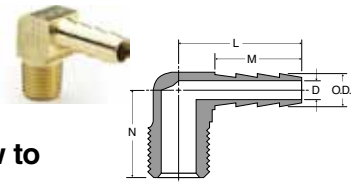

Hose Barb 90° Elbow to Male Pipe 129HB

PART NO.	I.D. HOSE SIZE	PIPE THREAD	L	M	N	O.D.	FLOW DIA. D
129HB-3-2	3/16	1/8	.97	.69	.66	.227	.173
129HB-4-2	1/4	1/8	1.04	.76	.66	.290	.187
129HB-4-4	1/4	1/4	1.06	.76	.82	.290	.187
129HB-4-6	1/4	3/8	1.19	.76	.84	.290	.187
129HB-5-2	5/16	1/8	1.06	.76	.66	.353	.234
129HB-5-4	5/16	1/4	1.12	.76	.84	.353	.234
129HB-5-6	5/16	3/8	1.19	.76	.84	.353	.234
129HB-6-2	3/8	1/8	1.32	.97	.75	.415	.219
129HB-6-4	3/8	1/4	1.32	.97	.94	.415	.281
129HB-6-6	3/8	3/8	1.50	.97	1.06	.415	.281
129HB-6-8	3/8	1/2	1.52	.97	1.25	.415	.281
129HB-8-4	1/2	1/4	1.53	.97	1.06	.530	.375
129HB-8-6	1/2	3/8	1.53	.97	1.06	.530	.375
129HB-8-8	1/2	1/2	1.53	.97	1.25	.530	.375
129HB-12-12	3/4	3/4	1.33	.79	1.27	.790	.562

Ball-End Joint Adapter to Male Pipe 127HB

For use with 128HBLSV

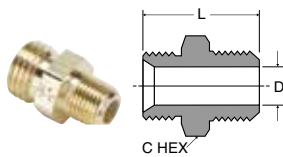

PART NO.	MALE N.P.S.M. THREAD	MALE N.P.T. THREAD	C HEX	L	FLOW DIA. D
127HB-4-2	1/4	1/8	9/16	.91	.219
127HB-4-4	1/4	1/4	9/16	1.10	.281
127HB-6-4	3/8	1/4	11/16	1.10	.312
127HB-6-6	3/8	3/8	11/16	1.15	.406
127HB-8-6	1/2	3/8	7/8	1.25	.406
127HB-8-8	1/2	1/2	7/8	1.50	.531

Hose Barb Elbow to SAE Straight Thread 1295HB

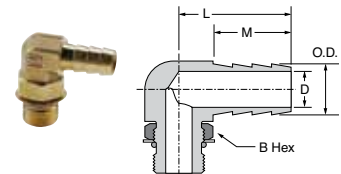

PART NO.	I.D. HOSE SIZE	STRAIGHT THREAD	B HEX	L	M	O.D.	FLOW DIA. D
1295HB-6-6	3/8	9/16-18	11/16	1.10	1.11	.410	.270

Note: Fluorocarbon o-ring is standard

WARNING These products can expose you to chemicals including NICKEL or LEAD, which are known to the state of California to cause cancer, and LEAD which is known to cause birth defects or other reproductive harm. For more information go to www.P65Warnings.ca.gov.

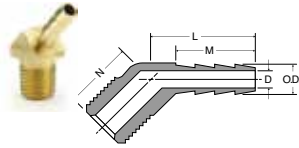

Hose Barb 45° Elbow to Male Pipe 139HB

PART NO.	I.D. HOSE SIZE	PIPE THREAD	L	M	N	O.D.	FLOW DIA. D
139HB-4-2	1/4	1/8	.91	.76	.68	.290	.187
139HB-4-4	1/4	1/4	1.00	.76	.68	.290	.187
139HB-6-4	3/8	1/4	1.00	.76	.68	.415	.281

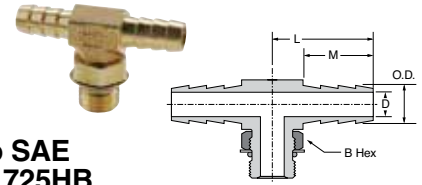

Hose Barb Tee to SAE Straight Thread 1725HB

PART NO.	I.D. HOSE SIZE	STRAIGHT THREAD	B HEX	L	M	O.D.	FLOW DIA. D
1725HB-6-6	3/8	9/16-18	11/16	1.10	.76	.420	.280

Note: Fluorocarbon o-ring is standard

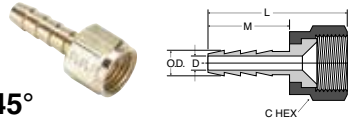

Hose Barb to Swivel 45° Female Flare 146HBLFSV

PART NO.	I.D. HOSE SIZE	STRAIGHT THREAD	C HEX	L	M	O.D.	FLOW DIA. D
146HBLFSV-4-4	1/4	7/16-20	9/16	1.55	.97	.290	.187
146HBLFSV-4-6	1/4	5/8-18	3/4	1.72	.97	.290	.187
146HBLFSV-6-6	3/8	5/8-18	3/4	1.72	.97	.415	.281

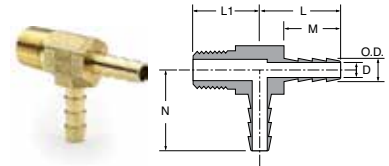

Hose Barb Tee to Male Pipe 171HB

PART NO.	I.D. HOSE SIZE	PIPE THREAD	L	L1	M	N	O.D.	FLOW DIA. D
171HB-4-4	1/4	1/4	1.10	.85	.76	1.10	.290	.187

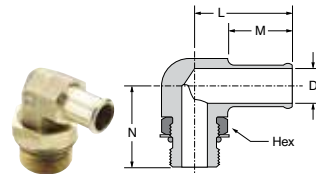

Beaded Hose Barb Elbow to SAE Straight Thread 1695HB

PART NUMBER	HOSE SIZE	STRAIGHT THREAD	HEX	L	M	N	D
1695HB-6-4	3/8	7/16-20	9/16	1.09	.78	1.10	.18
1695HB-8-6	1/2	9/16-18	9/16	1.10	.78	1.11	.30
1695HB-8-8	1/2	3/4-16	7/8	1.28	.78	1.42	.40
1695HB-10-8	5/8	3/4-16	7/8	1.47	.88	1.47	.40
1695HB-10-10	5/8	7/8-14	1	1.41	.88	1.60	.50
1695HB-12-8	3/4	3/4-16	7/8	1.47	.97	1.47	.40
1695HB-12-10	3/4	7/8-14	1	1.60	.97	1.62	.50
1695HB-12-12	3/4	1 1/16-12	1	1.60	.97	1.64	.62
1695HB-16-12	1	1 1/16-12	1 1/4	1.60	.97	1.75	.60

Note: Fluorocarbon o-ring is standard

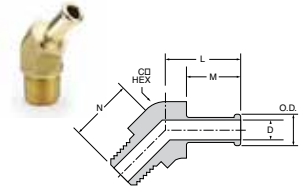

Beaded Hose Barb 45° Elbow Tube to Male Pipe 179HB

PART NO.	I.D. HOSE SIZE	NPTF THREAD	C HEX	L	M	N	O.D.	FLOW DIA. D
179HB-6-4	3/8	1/4-18	.75	1.09	.78	.93	.45	.28
179HB-6-6	3/8	3/8-18	.75	1.09	.78	.93	.45	.28
179HB-10-8	5/8	1/2-14	.81	1.19	.78	1.13	.70	.50
179HB-12-8	3/4	1/2-14	.81	1.19	.78	1.13	.83	.56

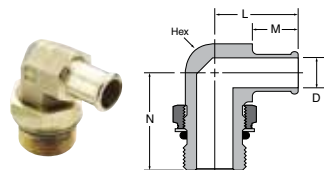

Beaded Elbow to Metric Adaptor 169HB-X-MIX

PART NUMBER	HOSE SIZE	METRIC THREAD	HEX	L	M	N	D
169HB-10-MI27	5/8	M27 X 2.0	7/8	1.41	.78	1.63	.50
169HB-16-MI27	1	M27 X 2.0	1	1.67	.97	1.68	.71
169HB-16-MI33	1	M33 X 2.0	1 5/16	1.75	.97	1.90	.84

Note: Fluorocarbon o-ring is standard

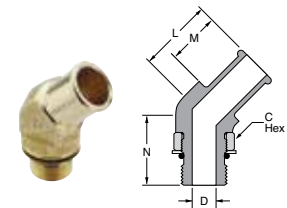

Beaded Hose Barb 45° Elbow Tube to Straight Thread 1795HB

PART NO.	I.D. HOSE SIZE	STRAIGHT THREAD	C HEX	L	M	N	FLOW DIA. D
1795HB-8-8	1/2	3/4-16	7/8	1.12	.78	1.16	.400
1795HB-10-8	5/8	3/4-16	7/8	1.22	.88	1.16	.398
1795HB-12-8	3/4	3/4-16	7/8	1.22	.88	1.16	.398
1795HB-12-12	3/4	1 1/16-12	1 1/4	1.35	.97	1.65	.620
1795HB-16-12	1	1 1/16-12	1 1/4	1.38	.97	1.47	.620
1795HB-16-14	1	1 3/16-12	1 3/8	1.25	.97	1.80	.720

Note: Fluorocarbon o-ring is standard

WARNING These products can expose you to chemicals including NICKEL or LEAD, which are known to the state of California to cause cancer, and LEAD which is known to cause birth defects or other reproductive harm. For more information go to www.P65Warnings.ca.gov.

Beaded Hose Barb 45° Elbow to Metric Thread 179HB-X-MIX

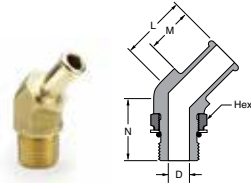

PART NUMBER	HOSE SIZE	METRIC THREAD	HEX	L	M	N	D
179HB-12-MI18	3/4	M18 X 1.5	13/16	1.15	.78	1.16	.44
179HB-16-MI27	1	M27 X 2.0	1 1/16	1.51	.97	1.71	.71

Note: Fluorocarbon o-ring is standard

Beaded Hose Barb 90° Elbow Tube to Male Pipe 269HB

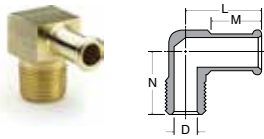

PART NO.	I.D. HOSE SIZE	PIPE THREAD	L	M	N	FLOW DIA. D
269HB-6-6	3/8	3/8	1.19	.78	.88	.281
269HB-8-4	1/2	1/4	1.16	.78	.99	.310
269HB-8-6	1/2	3/8	1.16	.78	1.08	.406
269HB-8-8	1/2	1/2	1.28	.78	1.25	.406
269HB-10-4	5/8	1/4	1.13	.78	.99	.312
269HB-10-6	5/8	3/8	1.16	.78	.99	.406
269HB-10-8	5/8	1/2	1.28	.78	1.25	.501
269HB-12-8	3/4	1/2	1.28	.78	1.25	.563
269HB-12-12	3/4	3/4	1.33	.78	1.27	.625

Beaded Hose Barb 45° Elbow Tube to Male Pipe 279HB

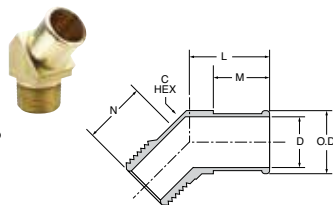

PART NO.	I.D. HOSE SIZE	NPTF THREAD	C HEX	L	M	N	O.D.	FLOW DIA. D
279HB-16-12	1	3/4-14	1.12	1.38	.97	1.13	1.06	.720

0123 Barbed Adapter for Rubber Hose BSPT

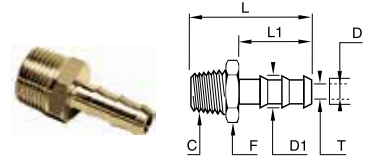

PART NO.	D MM	C BSPT	D1 MM	F MM	L MM	L1 MM	T MIN MM	WT. KG
0123 04 10	4	R1/8	6	10	34	22.5	3.3	.008
0123 06 10	6	R1/8	8	10	34	22.5	5	.009
0123 07 10	7	R1/8	9	10	34	22.5	5	.009
0123 07 13	7	R1/4	9	14	38.5	22.5	6	.018
0123 07 17	7	R3/8	9	17	39	22.5	6	.023
0123 10 10	10	R1/8	12.2	13	34	22.5	5	.014
0123 10 13	10	R1/4	12.2	14	38.5	22.5	7	.021
0123 10 17	10	R3/8	12.2	17	39	22.5	9.5	.023
0123 12 17	12	R3/8	14	17	46	29.5	11	.026
0123 13 13	13	R1/4	15	17	45.5	29.5	7	.027
0123 13 17	13	R3/8	15	17	46	29.5	11	.027
0123 13 21	13	R1/2	15	22	50.5	29.5	12	.047
0123 16 17	16	R3/8	18.5	19	54.5	38	11	.040
0123 16 21	16	R1/2	18.5	22	59	38	14	.056
0123 16 27	16	R3/4	18.5	27	62	38	15	.082
0123 19 17	19	R3/8	21.5	22	54.5	38	11	.046
0123 19 21	19	R1/2	21.5	22	59	38	14	.058
0123 19 27	19	R3/4	21.5	27	62	38	18	.083
0123 25 27	25	R3/4	26.7	27	62	38	18	.083
0123 25 34	25	R1	27	36	65	38	24	.124
0123 32 34	32	R1	34.5	36	70	43	24	.144

WARNING These products can expose you to chemicals including NICKEL or LEAD, which are known to the state of California to cause cancer, and LEAD which is known to cause birth defects or other reproductive harm. For more information go to www.P65Warnings.ca.gov.

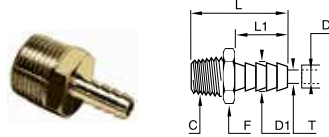

0136 Barbed Adapter for Nylon Tube BSPT

PART NO.	D MM	C BSPT	D1 MM	F MM	L MM	L1 MM	T MIN MM	WT. KG
0136 06 10	6	R1/8	6.4	10	26.5	15	4	.007
0136 06 13	6	R1/4	6.4	14	31	15	4	.015
0136 06 17	6	R3/8	6.4	17	31.5	15	4	.020
0136 08 13	8	R1/4	8.4	14	31	15	6	.016
0136 08 17	8	R3/8	8.4	17	31.5	15	6	.020
0136 08 21	8	R1/2	8.4	22	36	15	6	.039
0136 10 13	10	R1/4	10.7	14	36	20	7	.019
0136 10 17	10	R3/8	10.7	17	36.5	20	8	.023
0136 10 21	10	R1/2	10.7	22	41	20	8	.040
0136 12 13	12	R1/4	12.7	14	36	20	7	.019
0136 12 17	12	R3/8	12.7	17	36.5	20	10	.023
0136 12 21	12	R1/2	12.7	22	41	20	10	.042
0136 12 27	12	R3/4	12.7	27	44	20	10	.072
0136 13 17	13	R3/8	13.7	17	36.5	20	11	.023
0136 13 21	13	R1/2	13.7	22	41	20	11	.041
0136 13 27	13	R3/4	13.7	27	44	20	11	.071

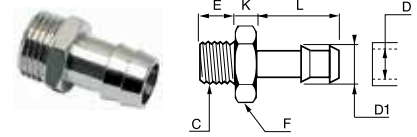

0931 Nickel Plated Hose to Male BSPP

PART NO.	D MM	C BSPP	D1 MM	E MM	F MM	K MM	L MM	WT. KG
0931 06 10	6	G1/8	7	6	12	4	20	0.008
0931 06 13	6	G1/4	7	8	14	5	20	0.013
0931 07 10	7	G1/8	8	6	12	4	20	0.009
0931 07 13	7	G1/4	8	8	14	5	20	0.017
0931 07 17	7	G3/8	8	9	19	5	20	0.022
0931 08 10	8	G1/8	9	6	12	4	20	0.009
0931 08 13	8	G1/4	9	8	14	5	20	0.014
0931 08 17	8	G3/8	9	9	19	5	20	0.022
0931 10 13	10	G1/4	12	8	14	5	20	0.016
0931 10 17	10	G3/8	12	9	19	5	20	0.023
0931 10 21	10	G1/2	12	10	22	6	22	0.032
0931 15 17	15	G3/8	17	9	19	6	24	0.030
0931 15 21	15	G1/2	17	10	22	6	24	0.036
0931 18 21	18	G1/2	20	10	22	6	24	0.043

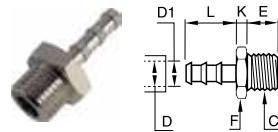

0191 Nickel Plated Hose to Male BSPP

PART NO.	D MM	C BSPP	D1 MM	E MM	F MM	K MM	L MM	WT. KG
0191 04 13	4	G1/4	6	9.5	17	5	22.5	.019
0191 07 13	7	G1/4	9	9.5	17	5	22.5	.021
0191 07 21	7	G1/2	9	11	27	7	29.5	.065
0191 10 13	10	G1/4	12.2	9.5	17	5	22.5	.021
0191 10 21	10	G1/2	12.2	11	27	7	29.5	.060
0191 13 13	13	G1/4	15.2	9.5	17	5	22.5	.023
0191 13 21	13	G1/2	15.2	11	27	7	29.5	.058
0191 16 21	16	G1/2	18.5	11	27	7	36.5	.069

WARNING These products can expose you to chemicals including NICKEL or LEAD, which are known to the state of California to cause cancer, and LEAD which is known to cause birth defects or other reproductive harm. For more information go to www.P65Warnings.ca.gov.



Industrial Adapters

Pipe Fittings

Metric Adapters

Nickel Plated
Metric Adapters

ISO Port Adapters

































Garden Hose Fittings



















Male Pipe to Male Pipe	215PN Close Nipple  p. J9	215PNL Long Nipple  p. J9	216P Hex Nipple  p. J9	1204P Male Elbow  p. J11	Male Pipe to Female Pipe	209P Bushing  p. J8
	222P Adapter  p. J10	1202P-2202P Street Elbow  p. J10	2224P Male Branch tee  p. J11	2225P Street Tee  p. J11		2214P 45° Street Elbow  p. J11
0158 Male Branch Tee  p. J14	0163 Bushing  p. J15	0913/0921 Street Elbow  p. J16	0911 Y Connector  p. J16	0916/0923 Male Branch Tee  p. J17	0917/0924 Male Run Tee  p. J17	0928 Female Branch Tee  p. J17
0909 Cross  p. J17	0904 Bushing  p. J18	Male NPT to Male BSPT	0121 Hex Nipple  p. J14	Female BSPP to Male BSPP	0169 Adapter  p. J15	0903 Adapter Reducer  p. J17
0905 Bushing  p. J18	0906 Adapter  p. J18		0907 Extended Adapter  p. J18		Male NPT to Female BSPP	0164 NPT-Female BSPP  p. J13
Male BSPT	0152 Union Elbow  p. J13	0929 3 Piece Adapter  p. J14	0914/0922 Union Elbow  p. J16	0927 Union Tee  p. J17		0900 Hex Nipple  p. J18
	Male BSPT to Male BSPP	0192 Hex Nipple  p. J19	Male BSPP	0901 Hex Nipple  p. J19	Tube to Metric Straight Thread	68NTA-X-MIX Male Connector  p. J21

WARNING These products can expose you to chemicals including CARBON BLACK, or LEAD, which are known to the state of California to cause cancer, and LEAD which is known to cause birth defects or other reproductive harm. For more information go to www.P65Warnings.ca.gov.

Female Pipe to Female Pipe	207ACBH Anchor Coupling  p. J8	207P Coupling  p. J8	208P Reducer Coupling  p. J8	212P Union  p. J8	1200P-2200P Union Elbow  p. J10	1203P-2203P Union Tee  p. J10
	2200PDE Drop-Ear Elbow  p. J11	1201-2201P 45° Female Elbow  p. J11	2205P Cross  p. J11	Female BSPP	0143 Union Elbow  p. J13	0145 Union Tee  p. J13
0155 Coupling  p. J14	0168 Adapter  p. J15	0912 Union Elbow  p. J16	0910 Union Y  p. J16		0915 Union Tee  p. J16	0908 Cross  p. J17
0902 Coupling  p. J19	Flare to Metric Straight Thread	48F-X-MIX Male Connector  p. J21	149F-X-MIX Male Elbow  p. J21	159F-X-MIX 45° Male Elbow  p. J21	Flare to Female Garden Hose	50GHSV Swivel Connector  p. J23
222P-X-MIX Adapter  p. J13, J21		Hose to Metric Straight Thread	68HB-X-MIX Male Connector  p. J21	169HB-X-MIX Male Elbow  p. J21		179HB-X-MIX 45° Male Elbow  p. J21
Female Pipe to Metric Straight Thread	69GH-70GH-71GH Male Pipe  p. J23		Garden Hose to Garden Hose	75GH Connector  p. J23	Garden Hose to Female Pipe	79GH-80GH-81GH Female Pipe  p. J23
	82GH-83GH Female Hose  p. J23	88GH Swivel Connector  p. J23		Female Garden Hose to Female Pipe		98GH-99GH Hose to Pipe  p. J24
Female Garden Hose to Male Pipe	82GH-83GH Female Hose  p. J23	88GH Swivel Connector  p. J23	98GH-99GH Hose to Pipe  p. J24		98GHSV-99GHSV Swivel Connector  p. J24	

WARNING These products can expose you to chemicals including CARBON BLACK, or LEAD, which are known to the state of California to cause cancer, and LEAD which is known to cause birth defects or other reproductive harm. For more information go to www.P65Warnings.ca.gov.

<p>Female Garden Hose</p>	<p>101GHSV Swivel Nut Connector  p. J24</p>	<p>Barb to Male Garden Hose</p>	<p>54GH-55GH Hose Barb  p. J23</p>	<p>Barb to Female Garden Hose</p>	<p>90GH Swivel Connector  p. J23</p>	
<p>Auxiliary Component</p>	<p>210P Lock Nut  p. J8</p>	<p>211P Square Head Plug  p. J8</p>	<p>213P Cap  p. J9</p>	<p>218P Hex Head Plug  p. J9</p>	<p>219P Countersunk Plug  p. J9</p>	<p>220P Slotted Head Plug  p. J10</p>
<p>94GH Hose Nut  p. J23</p>	<p>95GH Hose Nut Reducer  p. J24</p>	<p>96GH Hose Cap  p. J24</p>	<p>901GH Washer  p. J24</p>	<p>1163-60-BPD Coupler  p. J24</p>	<p>1163-61-BPD Nipple  p. J24</p>	

WARNING These products can expose you to chemicals including CARBON BLACK, or LEAD, which are known to the state of California to cause cancer, and LEAD which is known to cause birth defects or other reproductive harm. For more information go to www.P65Warnings.ca.gov.

Pipe Fittings



Parker's Pipe Fittings meet all functional requirements of SAE J530 and SAE J531. All threads on the pipe fittings are made to dryseal standards.

Product Features:

- All brass construction
- Meets functional requirements of SAE J530 and SAE J531
- Threads made to dryseal standards
- Both forgings and extrusions available

Markets:

- Industrial
- Construction
- Heavy duty truck
- Mobile
- Factory/process automation

Applications:

- Air Lines
- Water Line
- Cooling Lines

Specifications:

Pressure Range Up to 1000 PSI (68.9 bar)

Temperature Range -65° to +250° F (-53.9° to +121.1° C)

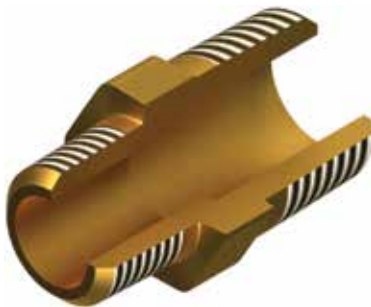

Assembly Instructions

Straight Fittings

1. Hand tighten external thread into internal thread
2. Tighten an additional 2 turns with a wrench up to 1/2" male pipe thread.
3. Above 1/2" 1 1/2 to 2 1/2 turns.

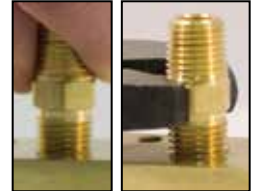

Elbow or Tee Fittings

1. Hand tighten external thread into internal thread
2. Tighten an additional 1 to 1 1/2 turns with a wrench
3. Tighten fitting, clockwise to align with tubing. (Never counter clockwise)



Note: To minimize the possibility of a leaking threaded joint after assembling Male to female pipe threads, neither end should be backed out (loosened) Once the assembly has been made.



WARNING These products can expose you to chemicals including LEAD which is known to the state of California to cause cancer and birth defects or other reproductive harm. For more information go to www.P65Warnings.ca.gov.



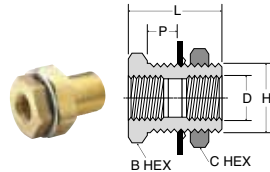

Anchor Coupling 207ACBH

PART NO.	FEAMLE PIPE THREAD	STRAIGHT THREAD	MAX. BULK HEAD P	B HEX	C HEX	L	BLKHD HOLE DIA. H	FLOW DIA. D
207ACBH-2	1/8	5/8-18	.89	7/8	15/16	1.50	5/8	.339
207ACBHS-2	1/8	5/8-18	.35	7/8	15/16	.96	5/8	.339
207ACBH-4	1/4	3/4-16	.81	1	1-1/8	1.50	3/4	.441
207ACBHS-4	1/4	3/4-16	.26	1	1	.94	3/4	.441
207ACBH-6	3/8	1-14	.62	1-1/8	1-1/4	1.31	1	.571
207ACBH-8	1/2	1-1/8-14	.75	1-1/4	1-3/8	1.50	1-1/8	.703
207ACBH-12	3/4	1-5/16-12	.65	1-1/2	1-1/2	1.50	1-5/16	.906
207ACBH-16*	1	1-5/8-14	1.00	2	2	1.68	1-5/8	1.140

*Lock Washer not Available

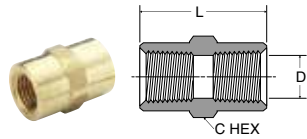

Coupling 207P

PART NO.	PIPE THREAD	C HEX	L	FLOW DIA. D
207P-2	1/8	9/16	.75	.339
207P-4	1/4	3/4	1.12	.441
207P-6	3/8	7/8	1.12	.571
207P-8	1/2	1-1/16	1.50	.703
207P-12	3/4	1-3/8	1.53	.906

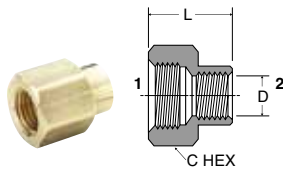

Reducer Coupling 208P

PART NO.	1 PIPE THREAD	2 PIPE THREAD	C HEX	L	FLOW DIA. D
208P-4-2	1/4	1/8	3/4	.97	.339
208P-6-4	3/8	1/4	7/8	1.16	.441
208P-8-4	1/2	1/4	1-1/16	1.28	.441
208P-8-6	1/2	3/8	1-1/16	1.38	.571
208P-12-6	3/4	3/8	1-3/8	1.32	.571
208P-12-8	3/4	1/2	1-3/8	1.50	.703

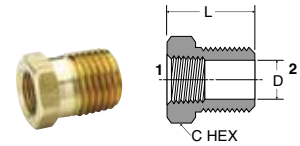

Bushing 209P

PART NO.	1 PIPE THREAD	2 PIPE THREAD	C HEX	L	FLOW DIA. D
209P-4-2	1/8	1/4	9/16	.75	.339
209P-6-2	1/8	3/8	11/16	.75	.339
209P-6-4	1/4	3/8	3/4	.75	.441
209P-8-2	1/8	1/2	7/8	1.00	.339
209P-8-4	1/4	1/2	7/8	1.00	.441
209P-8-6	3/8	1/2	7/8	1.00	.571
209P-12-2	1/8	3/4	1-1/8	1.00	.339
209P-12-4	1/4	3/4	1-1/8	1.00	.441
209P-12-6	3/8	3/4	1-1/8	1.00	.571
209P-12-8	1/2	3/4	1-1/8	1.00	.703
209P-16-8	1/2	1	1-3/8	1.31	.703
209P-16-12	3/4	1	1-3/8	1.31	.906

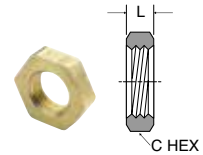

Lock Nut 210P

PART NO.	PIPE THREAD	C HEX	L
210P-2	1/8 NPSL	11/16	.19
210P-4	1/4 NPSL	7/8	.25
210P-6	3/8 NPSL	1	.25
210P-8	1/2 NPSL	1-1/8	.25

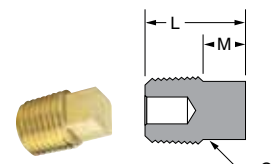

Square-Head Plug 211P

PART NO.	PIPE THREAD	C	L	M
211P-2	1/8	9/32	.59	.25
211P-4	1/4	3/8	.80	.29
211P-6	3/8	7/16	.83	.32
211P-8	1/2	9/16	1.07	.39
211P-12	3/4	5/8	1.14	.45

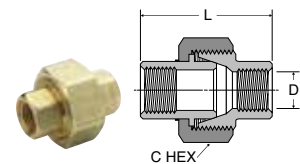

Union 212P

PART NO.	PIPE THREAD	C HEX	L	D
212P-4	1/4	1-3/16	1.54	.441
212P-6	3/8	1-1/4	1.76	.571

WARNING These products can expose you to chemicals including LEAD which is known to the state of California to cause cancer and birth defects or other reproductive harm. For more information go to www.P65Warnings.ca.gov.



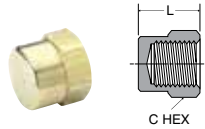

Cap 213P

PART NO.	PIPE THREAD	C HEX	L
213P-2	1/8	9/16	.50
213P-4	1/4	11/16	.63
213P-6	3/8	13/16	.63
213P-8	1/2	1-1/16	.87
213P-12	3/4	1-1/4	.89

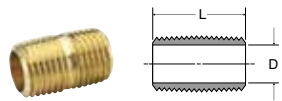

Close Nipple 215PN

PART NO.	PIPE THREAD	L	FLOW DIA. D
215PN-2	1/8	.75	.281
215PN-4	1/4	.88	.375
215PN-6	3/8	1.00	.500
215PN-8	1/2	1.13	.625
215PN-12	3/4	1.31	.750

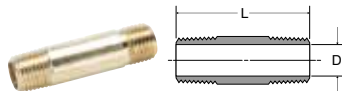

Long Nipple 215PNL

PART NO.	PIPE THREAD	L	FLOW DIA. D
215PNL-2-15	1/8	1-1/2	.250
215PNL-4-15	1/4	1-1/2	.375
215PNL-6-15	3/8	1-1/2	.500
215PNL-8-15	1/2	1-1/2	.625
215PNL-2-20	1/8	2	.250
215PNL-4-20	1/4	2	.375
215PNL-6-20	3/8	2	.500
215PNL-8-20	1/2	2	.625
215PNL-2-25	1/8	2-1/2	.250
215PNL-4-25	1/4	2-1/2	.375
215PNL-6-25	3/8	2-1/2	.500
215PNL-8-25	1/2	2-1/2	.625
215PNL-2-30	1/8	3	.250
215PNL-4-30	1/4	3	.375
215PNL-6-30	3/8	3	.500
215PNL-8-30	1/2	3	.625
215PNL-2-35	1/8	3-1/2	.250
215PNL-4-35	1/4	3-1/2	.375
215PNL-6-35	3/8	3-1/2	.500
215PNL-8-35	1/2	3-1/2	.625

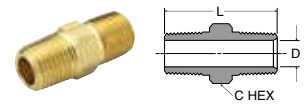

Hex Nipple 216P

PART NO.	PIPE THREAD	C HEX	L	FLOW DIA. D
216P-2	1/8	7/16	.97	.220
216P-4	1/4	9/16	1.38	.314
216P-6	3/8	11/16	1.41	.440
216P-8	1/2	7/8	1.81	.564
216P-12	3/4	1-1/16	1.81	.752

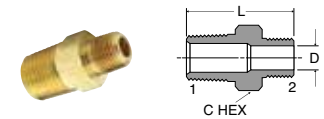

Hex Nipple Reducers 216P

PART NO.	1 PIPE THREAD	2 PIPE THREAD	C HEX	L	FLOW DIA. D
216P-4-2	1/4	1/8	9/16	1.19	.220
216P-6-2	3/8	1/8	11/16	1.22	.220
216P-6-4	3/8	1/4	11/16	1.41	.314
216P-8-4	1/2	1/4	7/8	1.62	.314
216P-8-6	1/2	3/8	7/8	1.62	.440
216P-12-8	3/4	1/2	1-1/16	1.80	.564

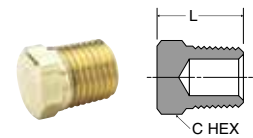

Hex-Head Plug 218P

PART NO.	PIPE THREAD	C HEX	L
218P-2	1/8	7/16	.560
218P-4	1/4	9/16	.747
218P-6	3/8	11/16	.780
218P-8	1/2	7/8	.970
218P-12	3/4	1-1/16	1.054

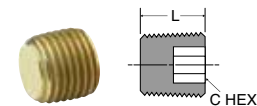

Countersunk Hex-Head Plug 219P

PART NO.	PIPE THREAD	C HEX	L
219P-2	1/8	3/16	.30
219P-4	1/4	1/4	.46
219P-6	3/8	5/16	.46
219P-8	1/2	3/8	.61
219P-12	3/4	9/16	.62

WARNING These products can expose you to chemicals including LEAD which is known to the state of California to cause cancer and birth defects or other reproductive harm. For more information go to www.P65Warnings.ca.gov.

Slotted-Head Plug 220P

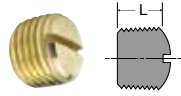

PART NO.	PIPE THREAD	L
220P-2	1/8	.31
220P-4	1/4	.42
220P-6	3/8	.43

Adapter 222P

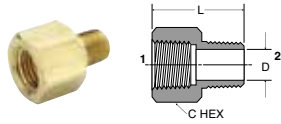

PART NO.	1 PIPE THREAD	2 PIPE THREAD	C HEX	L	FLOW DIA. D
222P-2-2	1/8	1/8	9/16	.88	.220
222P-4-2	1/4	1/8	3/4	1.06	.220
222P-4-4	1/4	1/4	3/4	1.25	.314
222P-6-2	3/8	1/8	7/8	1.10	.220
222P-6-4	3/8	1/4	7/8	1.25	.314
222P-6-6	3/8	3/8	7/8	1.25	.440
222P-8-4	1/2	1/4	1	1.47	.314
222P-8-6	1/2	3/8	1-1/16	1.47	.440
222P-8-8	1/2	1/2	1-1/16	1.66	.564
222P-12-6	3/4	3/8	1-3/8	1.50	.440
222P-12-8	3/4	1/2	1-3/8	1.69	.564
222P-12-12	3/4	3/4	1-3/8	1.69	.752

90° Street Elbow 1202P-2202P

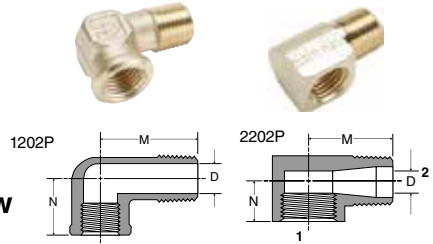

PART NO.	1 PIPE THREAD	2 PIPE THREAD	M	N	FLOW DIA. D
1202P-2-2	1/8	1/8	.81	.56	.22
2202P-2-2	1/8	1/8	.62	.48	.22
2202PA-2-2*	1/8	1/8	.66	.48	.22
2202P-4-2	1/4	1/8	.72	.45	.23
1202P-4-4	1/4	1/4	1.08	.69	.31
2202P-4-4	1/4	1/4	.91	.45	.34
2202PA-4-4*	1/4	1/4	.91	.72	.31
2202P-4-6	1/4	3/8	.97	.78	.43
1202P-6-4	3/8	1/4	1.25	.78	.31
1202P-6-6	3/8	3/8	1.25	.78	.42
2202P-6-6	3/8	3/8	.98	.54	.41
2202PA-6-6*	3/8	3/8	.97	.78	.43
1202P-6-8	3/8	1/2	1.53	1.01	.56
1202P-8-6	1/2	3/8	1.25	.97	.42
2202P-8-8	1/2	1/2	1.25	1.03	.56
2202P-12-8	3/4	1/2	1.39	1.10	.56
2202P-12-12	3/4	3/4	1.39	1.10	.75

*Meets SAE Dimensions

90° Union Elbow 1200P-2200P

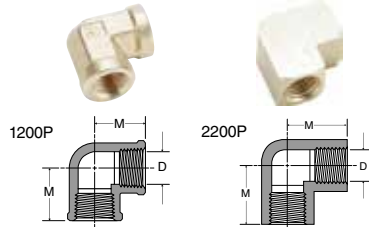

PART NO.	PIPE THREAD	M	FLOW DIA. D
1200P-2-2	1/8	.56	.329
2200P-2-2	1/8	.55	.339
1200P-4-4	1/4	.81	.441
2200P-4-4	1/4	.78	.441
1200P-6-6	3/8	.84	.571
2200P-6-6	3/8	.84	.571
2200P-8-8	1/2	1.07	.703

Union Tee 1203P-2203P

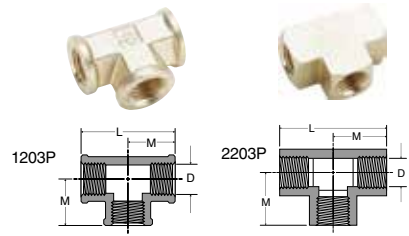

PART NO.	PIPE THREAD	L	M	FLOW DIA. D
1203P-2	1/8	1.12	.56	.339
2203P-2	1/8	1.06	.53	.339
1203P-4	1/4	1.38	.69	.441
2203P-4	1/4	1.52	.76	.441
2203P-6	3/8	1.68	.84	.571
1203P-8	1/2	2.14	1.07	.703
2203P-8	1/2	2.14	1.07	.703
2203P-12	3/4	2.28	1.14	.906

WARNING These products can expose you to chemicals including LEAD which is known to the state of California to cause cancer and birth defects or other reproductive harm. For more information go to www.P65Warnings.ca.gov.

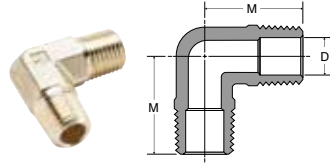

Male Elbow 1204P

PART NO.	PIPE THREAD	M	FLOW DIA. D
1204P-2	1/8	.71	.220
1204P-4	1/4	1.09	.312
1204P-6	3/8	1.09	.408
1204P-8	1/2	1.41	.502

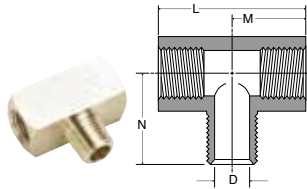

Male Branch Tee 2224P

PART NO.	PIPE THREAD	L	M	N	FLOW DIA. D
2224P-2	1/8	1.06	.53	.66	.220
2224P-4	1/4	1.52	.76	.91	.314
2224P-6	3/8	1.68	.84	.97	.440
2224P-8	1/2	2.18	1.09	1.25	.564
2224P-12	3/4	2.32	1.16	1.38	.752

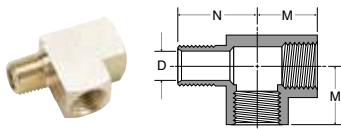

Street Tee 2225P

PART NO.	PIPE THREAD	M	N	DIA. D
2225P-2	1/8	.53	.66	.220
2225P-4	1/4	.76	.91	.314
2225P-6	3/8	.84	.98	.440
2225P-8	1/2	1.07	1.26	.564
2225P-12	3/4	1.14	1.38	.752

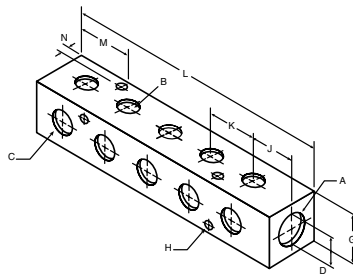

Brass Manifold 255M

PART NO.	PIPE THREAD A	PIPE THREAD B	PIPE THREAD C	G	MOUNTING HOLE DIA. H	J	K	L	M	N	D
255MP-6-4-2	3/8	1/8	1/4	1.25	.22	.88	1.13	6.25	1.45	.25	.25

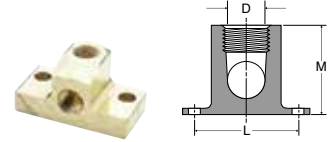

Drop-ear 90° Elbow 2200PDE

PART NO.	PIPE THREAD	L	M	FLOW DIA. D
2200PDE-2	1/8	1.38	1.00	.339

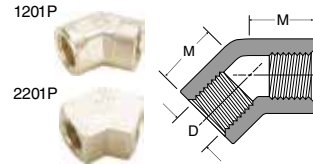

45° Female Elbow 1201P-2201P

PART NO.	PIPE THREAD	M	FLOW DIA. D
2201P-2-2	1/8	.43	.339
1201P-8-8	1/2	.89	.703

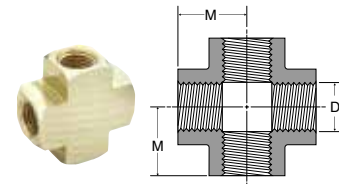

Cross 2205P

PART NO.	PIPE THREAD	M	FLOW DIA. D
2205P-2	1/8	.53	.339
2205P-4	1/4	.75	.441
2205P-6	3/8	.81	.571
2205P-8	1/2	1.07	.703
2205P-12	3/4	1.14	.906

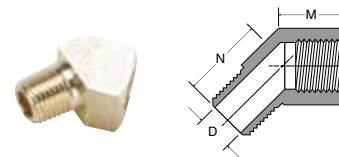

45° Street Elbow 2214P

PART NO.	PIPE THREAD	M	N	FLOW DIA. D
2214P-2-2	1/8	.38	.50	.220
2214P-4-4	1/4	.54	.70	.314
2214P-6-6	3/8	.56	.78	.440
2214P-8-8	1/2	.73	1.00	.564
2214P-12-12	3/4	.75	1.35	.750

WARNING These products can expose you to chemicals including LEAD which is known to the state of California to cause cancer and birth defects or other reproductive harm. For more information go to www.P65Warnings.ca.gov.



Metric Adapters

Parker's Metric Adapters offers a comprehensive range of NPT, BSPT, BSPP and metric pipe threads. Metric adapters are produced in both forgings and extrusions.

Product Features:

- All brass construction
- Nickel plated adapters
- Robust design
- Reusable

Markets:

- Industrial
- Construction
- Heavy duty truck
- Mobile
- Factory/process automation

Applications:

- Air Lines
- Water Line
- Cooling Lines

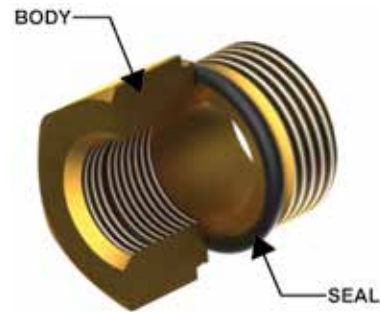

Specifications:

	Pressure Range	Temperature Range
Brass	1000 PSI (68.9 bar)	-40° to +302° F (-40° to +150° C)
Nickel-plated	870 PSI (59.9 bar)	-4° to +176° F (-20° to +80° C)

WARNING These products can expose you to chemicals including LEAD which is known to the state of California to cause cancer and birth defects or other reproductive harm. For more information go to www.P65Warnings.ca.gov.



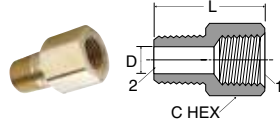

F3HG Adapter NPTF Male BSPT

PART NO.	NPTF 1	BSPT 2	C HEX	L	FLOW D
1/8F3HG-B	1/8	1/8	9/16	.93	.22
1/4F3HG-B	1/4	1/4	3/4	1.35	.31
3/8F3HG-B	3/8	3/8	7/8	1.35	.44
1/2F3HG-B	1/2	1/2	1-1/16	1.76	.56

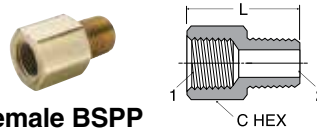

0164 Adapter Male NPT/Female BSPT

PART NO.	BSPP 1	NPTF 2	C HEX	L
0164 11 10	1/8	1/8	14	20
0164 14 13	1/4	1/4	17	27.5
0164 18 17	3/8	3/8	22	28.5
0164 22 21	1/2	1/2	27	36.5
0164 28 27	3/4	3/4	32	38.5

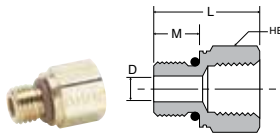

Pipe to Metric Adaptor 222P-X-MIX

PART NO.	NPTF	METRIC THREAD	HEX	L	M	D
222P-2-MI10	1/8-27	M10 X 1.0	9/16	.75	.34	.18
222P-2-MI14	1/8-27	M14 X 1.5	3/4	.91	.43	.30
222P-4-MI12	1/4-18	M12 X 1.5	11/16	1.09	.43	.24
222P-6-MI16	3/8-18	M16 X 1.5	7/8	1.10	.45	.35
222P-6-MI22	3/8-18	M22 X 1.5	1 1/16	1.05	.37	.47
222P-8-MI27	1/2-14	M27 X 2.0	1 1/4	1.32	.63	.60

Note: Fluorocarbon o-ring is standard

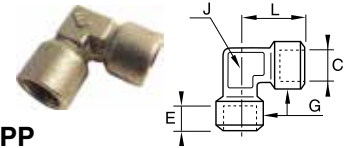

0143 90° Union Elbow BSPP

PART NO.	C BSPP	E MM	G MM	J MM	L MM	WT. KG
0143 10 10	G1/8	7.5	16.5	12	22.5	.042
0143 13 13	G1/4	11	18.5	15	26.5	.055
0143 17 17	G3/8	11.5	23.5	19	31.5	.098
0143 21 21	G1/2	15	28	23	35.5	.158
0143 27 27	G3/4	16.5	34	27	43.5	.256

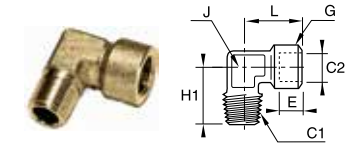

0144 Street Elbow Female BSPP to Male BSPT

PART NO.	C1 BSPT	C2 BSPP	E MM	G MM	H1 MM	J MM	L MM	WT. KG
0144 10 10	R1/8	G1/8	7.5	16.5	23	12	22.5	.033
0144 13 13	R1/4	G1/4	11	18.5	26	15	26.5	.050
0144 17 17	R3/8	G3/8	11.5	23.5	30	19	31.5	.085
0144 21 21	R1/2	G1/2	15	28	35	23	34.5	.138
0144 27 27	R3/4	G3/4	16.5	34	40	27	43.5	.229

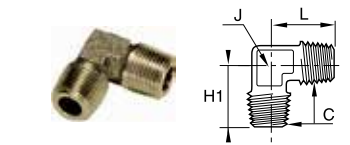

0152 Union Elbow Male BSPT

PART NO.	C BSPT	H1 MM	J MM	L MM	WT. KG
0152 10 10	R1/8	19.5	10	19.5	.018
0152 13 13	R1/4	25	15	25	.045
0152 17 17	R3/8	26.5	15	26.5	.056
0152 21 21	R1/2	31.5	19	31.5	.087
0152 27 27	R3/4	35.5	23	35.5	.153

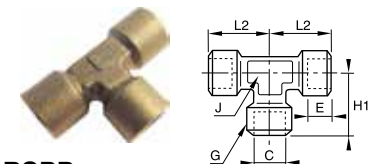

0145 Female Union Tee BSPP

PART NO.	C BSPP	E MM	G MM	H1 MM	J MM	L2 MM	WT. KG
0145 10 10	G1/8	7.5	16.5	22.5	12	22.5	.051
0145 13 13	G1/4	11	18.5	26.5	15	26.5	.074
0145 17 17	G3/8	11.5	23.5	31	19	31	.147
0145 21 21	G1/2	15	28	38	23	38	.231
0145 27 27	G3/4	16.5	34	47.5	27	47.5	.381

WARNING These products can expose you to chemicals including LEAD which is known to the state of California to cause cancer and birth defects or other reproductive harm. For more information go to www.P65Warnings.ca.gov.

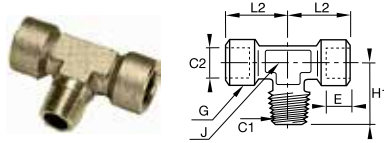

0158 Branch Tee Female BSPP to Male BSPT

PART NO.	C1 BSPT	C2 BSPP	E MM	G MM	H1 MM	J MM	L2 MM	WT. KG
0158 10 10	R1/8	G1/8	7.5	16.5	21.5	12	21.5	.045
0158 13 13	R1/4	G1/4	11	18.5	26	15	26	.071
0158 17 17	R3/8	G3/8	11.5	23.5	30	19	30	.118
0158 21 21	R1/2	G1/2	15	28	36	23	36	.203
0158 27 27	R3/4	G3/4	16.5	34	44	27	44	.320

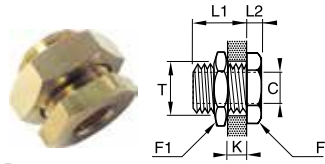

0117 Bulkhead BSPP and M5

PART NO.	C BSPP/M5	F MM	F1 MM	K MAX MM	L1 MM	L2 MM	T MAX MM	WT. KG
0117 00 19	M5X0.8	14	14	7	10.5	3.5	10.5	.013
0117 00 10	G1/8	19	22	9	14	4	16.5	.033
0117 00 13	G1/4	24	27	15	21	4	20.5	.057
0117 00 17	G3/8	30	32	14	21	5	26.5	.096
0117 00 21	G1/2	32	36	20	27	6	28.5	.117
0117 00 27	G3/4	41	41	22.5	30	6	34.5	.162
0117 00 34	G1	46	50	24.5	34	8	42.5	.270
0117 00 42	G1-1/4	55	55	29.5	39	8	49.5	.300
0117 00 49	G1-1/2	60	60	29.5	39	8	54.5	.306

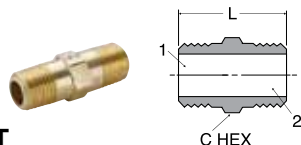

0121 Hex Nipple NPT/BSPT

PART NO.	NPTF 1	BSPT 2	C HEX	L
0121 11 10	1/8	1/8	11	19
0121 14 13	1/4	1/4	14	27
0121 18 17	3/8	3/8	17	28
0121 22 21	1/2	1/2	22	36
0121 28 27	3/4	3/4	27	40

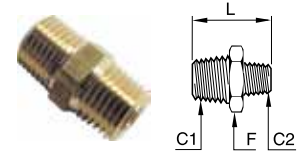

0121 Hex Nipple Male BSPT

PART NO.	C1 BSPT	C2 BSPT	F MM	L MM	WT. KG
0121 10 10	R1/8	R1/8	11	19	.009
0121 13 13	R1/4	R1/4	14	27	.021
0121 13 10	R1/4	R1/8	14	23.5	.021
0121 17 17	R3/8	R3/8	17	28	.025
0121 17 13	R3/8	R1/4	17	27.5	.024
0121 17 10	R3/8	R1/8	17	24	.022
0121 21 21	R1/2	R1/2	22	36	.053
0121 21 17	R1/2	R3/8	22	32.5	.045
0121 21 13	R1/2	R1/4	22	32	.045
0121 21 10	R1/2	R1/8	22	28.5	.041
0121 27 27	R3/4	R3/4	27	40	.092
0121 27 21	R3/4	R1/2	27	39	.084
0121 27 17	R3/4	R3/8	27	35.5	.076
0121 27 13	R3/4	R1/4	27	35	.079
0121 34 34	R1	R1	36	46	.156
0121 34 27	R1	R3/4	36	43	.143
0121 34 21	R1	R1/2	36	42	.133
0121 34 17	R1	R3/8	36	38.5	.126
0121 42 42	R1-1/4	R1-1/4	46	53	.233
0121 42 34	R1-1/4	R1	46	50.5	.237
0121 42 27	R1-1/4	R3/4	46	47.5	.229
0121 42 21	R1-1/4	R1/2	46	46.5	.219

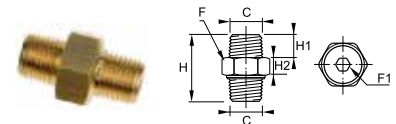

0929 3 Piece Adapter Double Male BSPT

PART NO.	C BSPT	F MM	F1 MM	H MM	H1 MM	H2 MM	WT. KG
0929 00 10	R1/8	15	5	27	9	8.5	0.181
0929 00 13	R1/4	19	6	33.5	11.5	9.5	0.100
0929 00 17	R3/8	22	8	36.5	13	10	0.010
0929 00 21	R1/2	27	12	45	15.5	12	0.088

Note: This connection accessory makes assembly easier thanks to its 3-piece design. To join the 2 threaded components, simply push together and tighten the nut.

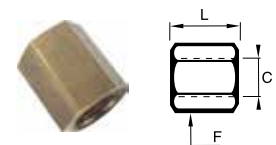

0155 Coupling BSPP

PART NO.	C BSPP	F MM	L MM	WT. KG
0155 10 10	G1/8	14	17	.015
0155 13 13	G1/4	17	24	.025
0155 17 17	G3/8	22	25	.045
0155 21 21	G1/2	27	32	.084
0155 27 27	G3/4	32	35	.109

WARNING These products can expose you to chemicals including LEAD which is known to the state of California to cause cancer and birth defects or other reproductive harm. For more information go to www.P65Warnings.ca.gov.

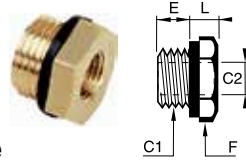

0168 Adapter Reducer Female BSPP to Male BSPP

PART NO.	C1 BSPP	C2 BSPP	E MM	F MM	L MM	WT. KG
0168 10 19	G1/8	M5X0.8	7	14	6	.008
0168 13 19	G1/4	M5X0.8	7	17	7	.010
0168 13 10	G1/4	G1/8	7	17	7	.010
0168 17 10	G3/8	G1/8	9	19	6	.020
0168 17 13	G3/8	G1/4	9	19	6	.013
0168 21 10	G1/2	G1/8	11	24	10	.046
0168 21 13	G1/2	G1/4	11	24	10	.038
0168 21 17	G1/2	G3/8	11	24	10	.026
0168 27 13	G3/4	G1/4	11	32	12	.090
0168 27 17	G3/4	G3/8	11	32	12	.078
0168 27 21	G3/4	G1/2	11	32	12	.058

* With captive polymer seal

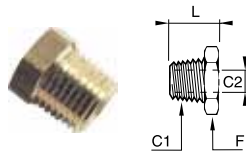

0163 Adapter Reducer Female BSPP to Male BSPT

PART NO.	C1 BSPT	C2 BSPP	F MM	L MM	WT. KG
0163 13 10	R1/4	G1/8	14	16	.009
0163 17 10	R3/8	G1/8	17	16.5	.020
0163 17 13	R3/8	G1/4	17	16.5	.012
0163 21 10	R1/2	G1/8	22	21	.047
0163 21 13	R1/2	G1/4	22	21	.038
0163 21 17	R1/2	G3/8	22	21	.025
0163 27 13	R3/4	G1/4	27	24	.086
0163 27 17	R3/4	G3/8	27	24	.069
0163 27 21	R3/4	G1/2	27	24	.048

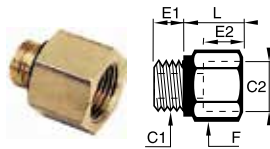

0169 Expander Female BSPP to Male BSPP

PART NO.	C1 BSPP	C2 BSPP	E1 MM	E2 MM	F MM	L MM	WT. KG
0169 10 13	G1/8	G1/4	5	11	17	16	.020
0169 10 17	G1/8	G3/8	5	14	22	19.5	.038
0169 13 17	G1/4	G3/8	7	14	22	19.5	.042
0169 13 21	G1/4	G1/2	7	14.5	27	20.5	.061
0169 17 21	G3/8	G1/2	8	14.5	27	20.5	.062
0169 17 27	G3/8	G3/4	8	15.5	32	22	.082
0169 21 27	G1/2	G3/4	9.5	15.5	32	22.5	.088

WARNING These products can expose you to chemicals including LEAD which is known to the state of California to cause cancer and birth defects or other reproductive harm. For more information go to www.P65Warnings.ca.gov.



Nickel Plated Metric Adapters

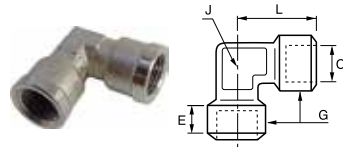

0912 Female Elbow BSPP and M5

PART NO.	C BSPP/M5	E MM	G MM	J MM	L MM	WT. KG
0912 00 19	M5	4	8	9	11	.037
0912 00 10	G1/8	8	13	10	21	.042
0912 00 13	G1/4	11	17	13	25.5	.055
0912 00 17	G3/8	11.5	21	17	28	.098
0912 00 21	G1/2	14	26	21	33.5	.158
0912 00 27	G3/4	15	31	27	36.5	.256

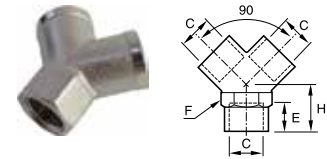

0910 "Y" Connector Female BSPP

PART NO.	C BSPP	E MM	F MM	H MM	WT. KG
0910 00 10	1/8	8	13	12	.055
0910 00 13	1/4	11	17	14	.081
0910 00 17	3/8	11.5	20	16	.128
0910 00 21	1/2	14	25	19	.213

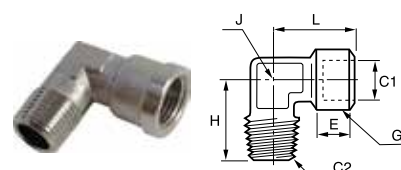

0913 / 0921 Street Elbow Female BSPP to Male BSPT and M5

PART NO.	C1 BSPP/M5	C2 BSPT	E MM	G MM	H MM	J MM	L MM	WT. KG
0921 00 19	M5		4	8	11	9	11	.037
0913 00 10	G1/8	R1/8	8	13	18.5	10	21	.033
0913 00 13	G1/4	R1/4	11	17	23.5	13	25.5	.050
0913 00 17	G3/8	R3/8	11.5	21	26	17	28	.085
0913 00 21	G1/2	R1/2	14	26	31	21	33.5	.138
0913 00 27	G3/4	R3/4	15	31	35	27	36.5	.229

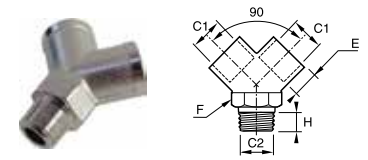

0911 "Y" Connector Female BSPP to Male BSPT

PART NO.	C1 BSPP	C2 BSPT	E	F	H	WT.
0911 00 10	G1/8	R1/8	8	13	12	.055
0911 00 13	G1/4	R1/4	11	17	14	.081
0911 00 17	G3/8	R3/8	11.5	20	16	.128
0911 00 21	G1/2	R1/2	14	25	19	.213



0914 / 0922 Equal Elbow Male BSPT or M5

PART NO.	C BSPT/M5	H MM	J MM	L MM	WT. KG
0922 00 19	M5	11	9	11	.037
0914 00 10	R1/8	18.5	10	18.5	.018
0914 00 13	R1/4	23.5	13	23.5	.045
0914 00 17	R3/8	26	17	26	.056
0914 00 21	R1/2	31	21	31	.087
0914 00 27	R3/4	35	27	35	.153

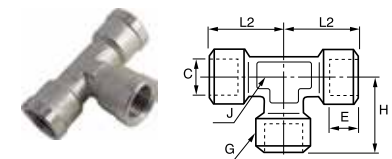

0915 Female Tee BSPP or M5

PART NO.	C BSPP/M5	E MM	G MM	H MM	J MM	L2 MM	WT. KG
0915 00 19	M5	4	8	11	9	11	.047
0915 00 10	G1/8	8	13	21	10	21	.051
0915 00 13	G1/4	11	17	25.5	13	25.5	.074
0915 00 17	G3/8	11.5	21	28	17	28	.147
0915 00 21	G1/2	14	26	33.5	21	33.5	.231
0915 00 27	G3/4	15	31	36.5	27	36.5	.381

WARNING These products can expose you to chemicals including LEAD which is known to the state of California to cause cancer and birth defects or other reproductive harm. For more information go to www.P65Warnings.ca.gov.

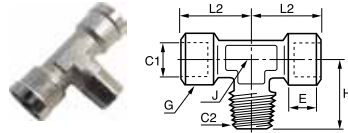

0916 / 0923 Branch Tee Female BSPP to Male BSPT

PART NO.	C1 BSPP/M5	C2 BSPT	E MM	G MM	H MM	J MM	L2 MM	WT. KG
0923 00 19	M5		4	8	11	9	11	.040
0916 00 10	G1/8	R1/8	8	13	18.5	10	21	.045
0916 00 13	G1/4	R1/4	11	17	23.5	13	25.5	.071
0916 00 17	G3/8	R3/8	11.5	21	26	17	28	.118
0916 00 21	G1/2	R1/2	14	26	31	21	33.5	.203
0916 00 27	G3/4	R3/4	15	31	36.5	27	36.5	.320

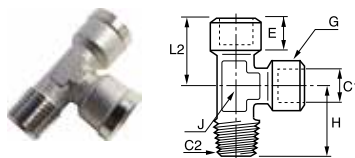

0917 / 0924 Run Tee Female BSPP to Male BSPT or M5

PART NO.	C1 BSPP/M5	C2 BSPT	E MM	G MM	H MM	J MM	L2 MM	WT. KG
0924 00 19	M5		4	8	11	9	11	.040
0917 00 10	G1/8	R1/8	8	13	18.5	10	21	.045
0917 00 13	G1/4	R1/4	11	17	23.5	13	25.5	.071
0917 00 17	G3/8	R3/8	11.5	21	26	17	28	.118
0917 00 21	G1/2	R1/2	14	26	31	21	33.5	.203
0917 00 27	G3/4	R3/4	15	31	36.5	27	36.5	.320

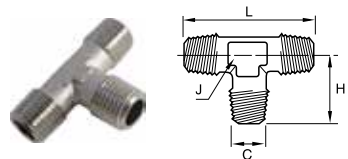

0927 Equal Male Tee BSPT

PART NO.	C BSPT	H MM	J MM	L MM	WT. KG
0927 00 10	R1/8	18.5	10	37	.017
0927 00 13	R1/4	23.5	13	47	.038
0927 00 17	R3/8	26	17	52	.057
0927 00 21	R1/2	31	21	62	.093

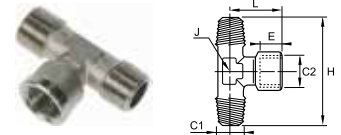

0928 Male Stud Branch Tee BSPT Female BSPP

PART NO.	C1 BSPT	C2 BSPP	E MM	H MM	J MM	L MM	WT. KG
0928 00 10	R1/8	G1/8	8	37	10	21	0.021
0928 00 13	R1/4	G1/4	11	47	13	25.5	0.044
0928 00 17	R3/8	G3/8	11.5	52	17	28	0.066
0928 00 21	R1/2	G1/2	14	62	21	33.5	0.109

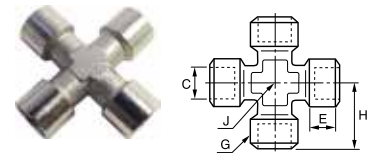

0908 Cross Female BSPP

PART NO.	C BSPP	E MM	G MM	H MM	J MM	WT. KG
0908 00 10	G1/8	8	13	21	10	.055
0908 00 13	G1/4	11	17	25.5	13	.081
0908 00 17	G3/8	11.5	21	28	17	.128
0908 00 21	G1/2	14	26	33.5	21	.213

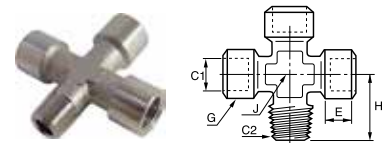

0909 Cross Female BSPP to Male BSPT

PART NO.	C1 BSPP	C2 BSPT	E MM	G MM	H MM	J MM	WT. KG
0909 00 10	G1/8	R1/8	8	13	18.5	10	.055
0909 00 13	G1/4	R1/4	11	17	23.5	13	.081
0909 00 17	G3/8	R3/8	11.5	21	26	17	.128
0909 00 21	G1/2	R1/2	14	26	31	21	.213

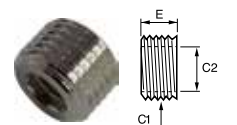

0903 Adapter Reducer BSPP

PART NO.	C1 BSPP	C2 BSPP	E MM	WT. KG
0903 10 13	G1/4	G1/8	8	.009
0903 13 17	G3/8	G1/4	9	.020
0903 17 21	G1/2	G3/8	10	.025
0903 21 27	G3/4	G1/2	14	.048
0903 27 34	G1"	G3/4	20	.060

WARNING These products can expose you to chemicals including LEAD which is known to the state of California to cause cancer and birth defects or other reproductive harm. For more information go to www.P65Warnings.ca.gov.

0904 Adapter Reducer Female BSPP to Male BSPT

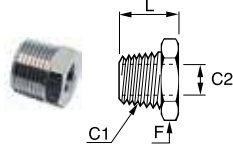

PART NO.	C1 BSPT	C2 BSPP	F MM	L MM	WT. KG
0904 10 13	R1/4	G1/8	14	16	.009
0904 10 17	R3/8	G1/8	17	16.5	.020
0904 13 17	R3/8	G1/4	17	16.5	.012
0904 13 21	R1/2	G1/4	22	19.5	.038
0904 17 21	R1/2	G3/8	22	19.5	.025
0904 17 27	R3/4	G3/8	27	23.5	.069
0904 21 27	R3/4	G1/2	27	23.5	.048

0907 Extended Adapter BSPP

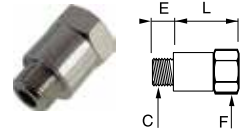

PART	C BSPP	E MM	F MM	L MM	WT. KG
0907 00 10	G1/8	6	14	16	.009
0907 00 10 01	G1/8	6	14	36	.009
0907 00 13	G1/4	8	17	23	.020
0907 00 13 01	G1/4	8	17	43	.020

0905 Adapter Reducer Male BSPP to Female BSPP or M5

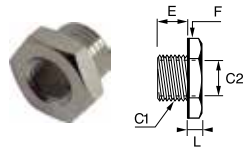

PART NO.	C1 BSPP	C2 BSPP M5	E MM	F MM	L MM	WT. KG
0905 19 10	G1/8	M5	6	14	4.5	.009
0905 10 13	G1/4	G1/8	8	17	5	.009
0905 10 17	G3/8	G1/8	9	19	5	.020
0905 13 17	G3/8	G1/4	9	19	5	.012
0905 13 21	G1/2	G1/4	10	24	5.5	.038
0905 17 21	G1/2	G3/8	10	24	5.5	.025
0905 17 27	G3/4	G3/8	12	30	5.5	.069
0905 21 27	G3/4	G1/2	12	30	5.5	.048

0920 Bulkhead BSPP and M5

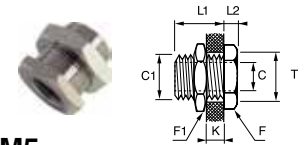

PART NO.	C1 METRIC	C BSPP M5	F MM	F1 MM	K MAX MM	L1 MM	L2 MM	T MIN MM	WT. KG
0920 00 19	M10X1	M5	14	14	7	10.5	3.5	10.5	.013
0920 00 10	M16X1.5	G1/8	19	22	9	14	4	16.5	.033
0920 00 13	M20X1.5	G1/4	24	27	15	21	4	20.5	.057
0920 00 17	M26X1.5	G3/8	30	32	14	21	5	26.5	.096
0920 00 21	M28X1.5	G1/2	32	36	20	27	6	28.5	.117

0906 Expander Female BSPP to Male BSPP

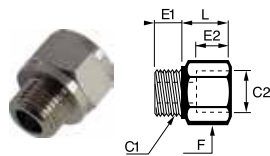

PART NO.	C1 BSPP/M5	C2 BSPP	E1 MM	E2 MM	F MM	L MM	WT. KG
0906 10 19	M5	G1/8	4	8	14	10	.009
0906 00 10	G1/8	G1/8	6	8.5	14	10	.009
0906 10 13	G1/8	G1/4	6	11.5	17	14	.020
0906 10 17	G1/8	G3/8	6	11.5	22	14.5	.038
0906 00 13	G1/4	G1/4	8	11.5	17	14	.040
0906 13 17	G1/4	G3/8	8	11.5	22	14.5	.042
0906 13 21	G1/4	G1/2	8	15	27	18	.061
0906 00 17	G3/8	G3/8	9	11.5	22	14.5	.061
0906 17 21	G3/8	G1/2	9	15	27	18	.062
0906 00 21	G1/2	G1/2	10	15	27	18	.070

0900 Male Straight Adapter BSPT

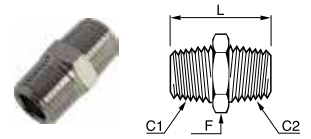

PART NO.	C1 BSPT	C2 BSPT	F MM	L MM	WT. KG
0900 00 10	R1/8	R1/8	12	19.5	.009
0900 10 13	R1/8	R1/4	14	23.5	.021
0900 00 13	R1/4	R1/4	14	27	.021
0900 10 17	R1/8	R3/8	17	24	.022
0900 13 17	R1/4	R3/8	17	27.5	.024
0900 00 17	R3/8	R3/8	17	28	.025
0900 13 21	R1/4	R1/2	22	30.5	.045
0900 17 21	R3/8	R1/2	22	31	.045
0900 00 21	R1/2	R1/2	22	33.5	.055
0900 21 27	R1/2	R3/4	27	37.5	.084
0900 00 27	R3/4	R3/4	27	40	.092
0900 27 34	R3/4	R1	34	43	.143
0900 00 34	R1	R1	34	45.5	.156

WARNING These products can expose you to chemicals including LEAD which is known to the state of California to cause cancer and birth defects or other reproductive harm. For more information go to www.P65Warnings.ca.gov.

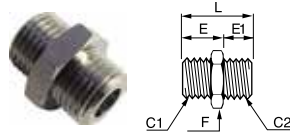

0901 Male Straight Adapter M5 or BSPP

PART NO.	C1 BSPP M5	C2 BSPP M5	E MM	E1 MM	F MM	L MM	WT. KG
0901 00 19	M5	M5	4	4	8	11.5	.002
0901 19 10	M5	G1/8	4	6	14	14.5	.008
0901 00 10	G1/8	G1/8	6	6	14	16.5	.008
0901 10 13	G1/8	G1/4	6	8	17	19	.014
0901 00 13	G1/4	G1/4	8	8	17	21	.016
0901 13 17	G1/4	G3/8	8	9	19	22	.021
0901 00 17	G3/8	G3/8	9	9	19	23	.024

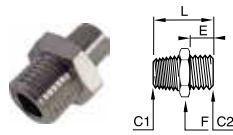

0192 Male Straight Adapter BSPT to BSPP

PART NO.	C1 BSPT	C2 BSPP	E MM	F MM	L MM	WT. KG
0192 10 13	R1/8	G1/4	9.5	17	23.5	.019
0192 13 13	R1/4	G1/4	9.5	17	27.5	.024
0192 13 21	R1/4	G1/2	27	27	31.5	.067
0192 17 13	R3/8	G1/4	9.5	17	45	.025
0192 17 21	R3/8	G1/2	27	27	31.5	.061
0192 21 21	R1/2	G1/2	27	27	34	.060

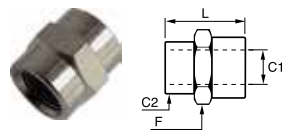

0902 Female Sleeve BSPP and M5

PART NO.	C1 BSPP/M5	C2 BSPP/M5	F MM	L MM	WT. KG
0902 00 19	M5	M5	8	11	.009
0902 19 10	M5	G1/8	14	13	.009
0902 00 10	G1/8	G1/8	14	15	.015
0902 10 13	G1/8	G1/4	17	19.5	.020
0902 00 13	G1/4	G1/4	17	22	.025
0902 10 17	G1/8	G3/8	22	20	.030
0902 13 17	G1/4	G3/8	22	23	.040
0902 00 17	G3/8	G3/8	22	24	.045
0902 13 21	G1/4	G1/2	27	27	.050
0902 17 21	G3/8	G1/2	27	27.5	.060
0902 00 21	G1/2	G1/2	27	30	.084
0902 21 27	G1/2	G3/4	30	30	.090
0902 00 27	G3/4	G3/4	30	32	.109

WARNING These products can expose you to chemicals including LEAD which is known to the state of California to cause cancer and birth defects or other reproductive harm. For more information go to www.P65Warnings.ca.gov.



ISO Port Adapters

Parker's ISO Port Adapters meet dimensional requirements of ISO 6149-3 and SAE 2244-3.

Product Features:

- All brass construction
- Fluorocarbon O-ring
- NPTF, flare, hose barb, NTA end configurations

Markets:

- Industrial
- Construction
- Mobile
- Factory/process automation

Applications:

- Air Lines
- Water Line
- Cooling Lines

Specifications:

Pressure Range Dependent on tubing or hose end connection

Temperature Range Dependent on tubing or hose end connection



WARNING These products can expose you to chemicals including LEAD which is known to the state of California to cause cancer and birth defects or other reproductive harm. For more information go to www.P65Warnings.ca.gov.



Pipe to Metric Adaptor 222P-X-MIX

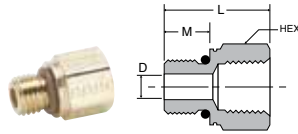

PART NUMBER	NPTF	METRIC THREAD	HEX	L	M	D
222P-2-MI10	1/8-27	M10 X 1.0	9/16	.75	.34	.18
222P-2-MI14	1/8-27	M14 X 1.5	3/4	.91	.43	.30
222P-4-MI12	1/4-18	M12 X 1.5	11/16	1.09	.43	.24
222P-4-MI14	1/4-18	M14 X 1.5	3/4	1.09	.43	.30
222P-6-MI16	3/8-18	M16 X 1.5	7/8	1.16	.45	.35
222P-6-MI22	3/8-18	M22 X 1.5	1 1/16	1.05	.51	.47
222P-8-MI27	1/2-14	M27 X 2.0	1 1/4	1.32	.63	.60

Note: Fluorocarbon o-ring is standard
For working pressure and Temperature see Metric Adapters Section

Flare to Metric Adaptor 48F-X-MIX

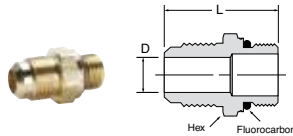

PART NUMBER	TUBE SIZE	METRIC THREAD	HEX	L	D
48F-8-MI16	1/2	M16 X 1.5	7/8	1.60	.35
48F-10-MI27	5/8	M27 X 2.0	1 1/4	1.87	.50
48F-12-MI27	3/4	M27 X 2.0	1 1/4	1.99	.63

Note: Fluorocarbon o-ring is standard
For working pressure and Temperature see SAE Flare Section

Flare Elbow to Metric Adaptor 149F-X-MIX

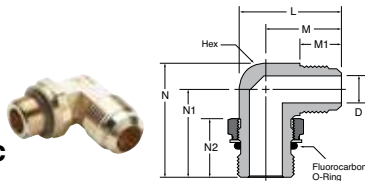

PART NUMBER	TUBE SIZE	METRIC THREAD	HEX	L	M	M1	N	N1	N2	D
149F-10-MI27	5/8	M27 X 2.0	7/8	1.95	1.46	.88	2.12	1.63	1.09	.50

Note: Fluorocarbon o-ring is standard
For working pressure and Temperature see SAE Flare Section

45° Flare Elbow to Metric Adaptor 159F-X-MIX

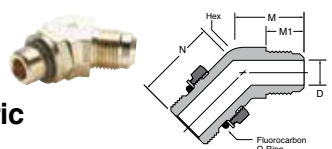

PART NUMBER	TUBE SIZE	METRIC THREAD	HEX	M	M1	N	D
159F-8-MI16	1/2	M16 X 1.5	13/16	1.10	.75	1.16	.36
159F-10-MI27	5/8	M27 X 2.0	1 1/8	1.21	.88	1.50	.50

Note: Fluorocarbon o-ring is standard
For working pressure and Temperature see SAE Flare Section

Hose Barb to Metric Adaptor 68HB-X-MIX

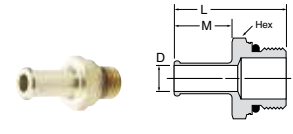

PART NUMBER	TUBE SIZE	METRIC THREAD	HEX	L	M	D
68HB-6-MI12	3/8	M12 X 1.5	11/16	1.50	.78	.24
68HB-6-MI14	3/8	M14 1.5	3/4	1.51	.78	.30
68HB-8-MI12	1/2	M12 X 1.5	11/16	1.50	.78	.24
68HB-10-MI27	5/8	M27 X 2.0	1 1/4	1.77	.78	.50

Note: Fluorocarbon o-ring is standard
For working pressure and Temperature see Hose Barb Section

Beaded Elbow to Metric Adaptor 169HB-X-MIX

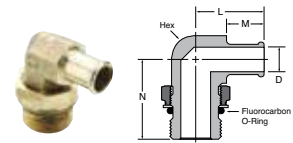

PART NUMBER	HOSE SIZE	METRIC THREAD	HEX	L	M	N	D
169HB-10-MI27	5/8	M27 X 2.0	7/8	1.41	.78	1.63	.50
169HB-16-MI27	1	M27 X 2.0	1	1.67	.97	1.68	.71

Note: Fluorocarbon o-ring is standard
For working pressure and Temperature see Hose Barb Section

NTA to Metric Adaptor 68NTA-X-MIX

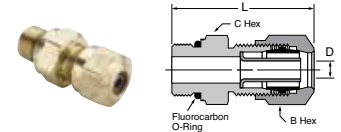

PART NUMBER	TUBE SIZE	METRIC THREAD	B HEX	C HEX	L	D
68NTA-4-MI10	1/4	M10 X 1.0	9/16	9/16	1.33	.140

Note: Fluorocarbon o-ring is standard
For working pressure and Temperature see Air Brake-NTA Section

Beaded Hose Barb 45° Elbow to Metric Thread 179HB-X-MIX

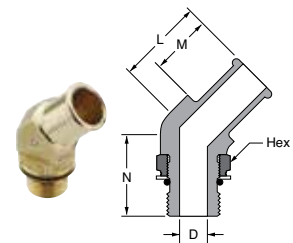

PART NUMBER	HOSE SIZE	METRIC THREAD	HEX	L	M	N	D
179HB-12-MI18	3/4	M18 X 1.5	13/16	1.15	.78	1.16	.44
179HB-16-MI27	1	M27 X 2.0	1 1/16	1.51	.97	1.71	.71

Note: Fluorocarbon o-ring is standard

WARNING These products can expose you to chemicals including LEAD which is known to the state of California to cause cancer and birth defects or other reproductive harm. For more information go to www.P65Warnings.ca.gov.

Garden Hose Fittings



Parker's Garden Hose Fittings connect garden hose to other garden hose, to pipe or to tubing. Swivel connections allow hose to twist without kinking.

Product Features:

- All brass construction
- 3/4" garden hose thread
- Rubber washer
- Flare, hose barb and pipe end configurations
- High Flow couplings

Markets:

- Industrial
- Mobile
- Factory/process automation

Applications:

- Water Line

Specifications:

Pressure Range Up to 150 PSI (10.3 bar)

Temperature Range +35° to +100° F at 75 PSI
(+1.6° to +37.7° C at 5.1 bar)

Compatible Tubing:

- Garden Hose

Note: 90Gh is intended for use with the 97HC hose clamp or crimped ferrule. All female connector ends should have a rubber washer(901GH-12) inserted prior to use.

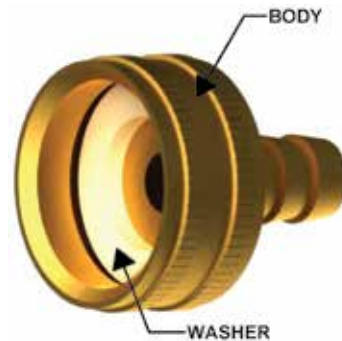

WARNING These products can expose you to chemicals including CARBON BLACK, or LEAD, which are known to the state of California to cause cancer, and LEAD which is known to cause birth defects or other reproductive harm. For more information go to www.P65Warnings.ca.gov.



Swivel Connector SAE Flare to Female Hose Thread 50GHSV

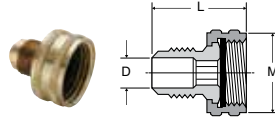

PART NO.	TUBE SIZE	HOSE THREAD	L	M	FLOW DIA. D
50GHSV-6-12	3/8	3/4	1.25	1.15	.297
50GHSV-8-12	1/2	3/4	1.34	1.15	.406

Female Hose to Male Pipe 82GH & 83GH

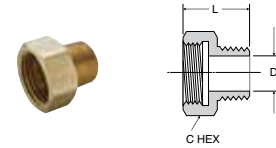

PART NO.	HOSE THREAD	PIPE THREAD	C HEX	L	FLOW DIA. D
82GH-12-8	3/4	1/2	1-3/16	1.20	.562
83GH-12-12	3/4	3/4	1-3/16	1.22	.750

Hose Barb to Male Hose Thread 53GH, 54GH & 55GH

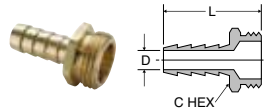

PART NO.	I.D. HOSE SIZE	HOSE THREAD	C HEX	L	FLOW DIA. D
53GH-8-12	1/2	3/4	1-1/16	1.88	.375
54GH-10-12	5/8	3/4	1-1/16	1.88	.500
55GH-12-12	3/4	3/4	1-1/16	1.88	.625

Swivel Connector Female Garden Hose to Male Pipe 88GH

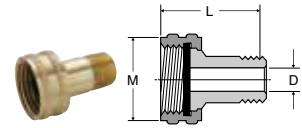

PART NO.	HOSE THREAD	PIPE THREAD	L	M	FLOW DIA. D
88GH-12-4	3/4	1/4	1.69	1.15	.312
88GH-12-6	3/4	3/8	1.69	1.15	.406

Male Hose to Male Pipe 69GH, 70GH, 71GH

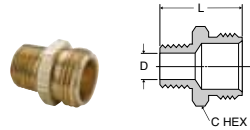

PART NO.	HOSE THREAD	PIPE THREAD	C HEX	L	FLOW DIA. D
69GH-12-4	3/4	1/4	1-1/16	1.25	.410
69GH-12-6	3/4	3/8	1-1/16	1.25	.406
70GH-12-8	3/4	1/2	1-1/16	1.39	.531
71GH-12-12	3/4	3/4	1-1/16	1.41	.750

Swivel Connector Female Garden Hose to Hose Barb 90GH

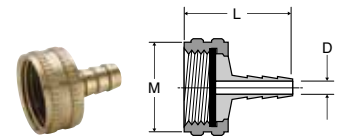

PART NO.	HOSE THREAD	I.D. HOSE SIZE	L	M	FLOW DIA. D
90GH-12-3	3/4	3/16	1.29	1.15	.125
90GH-12-4	3/4	1/4	1.21	1.15	.187
90GH-12-6	3/4	3/8	1.21	1.15	.281
90GH-12-8	3/4	1/2	1.21	1.15	.375
90GH-12-10*	3/4	5/8	1.93	1.19	.500
90GH-12-12*	3/4	3/4	1.93	1.19	.625

*Denotes hex body

Male Hose to Male Hose 75GH

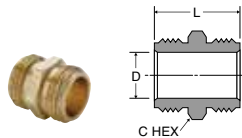

PART NO.	HOSE THREAD	C HEX	L	FLOW DIA. D
75GH-12	3/4	1-1/16	1.25	.750

Male Hose to Female Pipe 78GH, 79GH, 80GH & 81GH

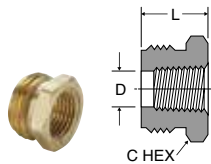

PART NO.	HOSE THREAD	PIPE THREAD	C HEX	L	FLOW DIA. D
78GH-12-4	3/4	1/4	1-1/16	.75	.422
79GH-12-6	3/4	3/8	1-1/16	.75	.562
80GH-12-8	3/4	1/2	1-1/16	.75	.687
81GH-12-12	3/4	3/4	1-3/16	1.28	.719

Knurled Hose Nut 94GH

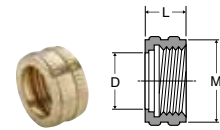

PART NO.	HOSE THREAD	L	M	FLOW DIA. D
94GH-12	3/4	.57	1.15	.808

WARNING These products can expose you to chemicals including CARBON BLACK, or LEAD, which are known to the state of California to cause cancer, and LEAD which is known to cause birth defects or other reproductive harm. For more information go to www.P65Warnings.ca.gov.



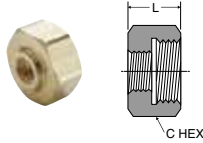

Hose Nut Reducer 95GH

PART NO.	HOSE THREAD	PIPE THREAD	C HEX	L
95GH-12-2	3/4	1/8	1-1/8	.63

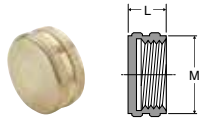

Hose Cap Nut 96GH

PART NO.	HOSE THREAD	L	M
96GH-12	3/4	.50	1.15

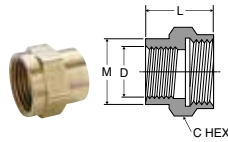

Female Hose to Female Pipe 98GH & 99GH

PART NO.	HOSE THREAD	PIPE THREAD	C HEX	L	M	FLOW DIA. D
98GH-12-8	3/4	1/2	1-3/16	1.14	1.01	.687
99GH-12-12	3/4	3/4	1-3/16	1.25	1.17	.750

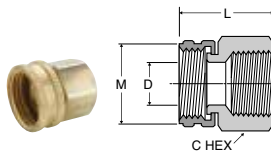

Swivel Connector Female Hose to Female Pipe 98GHSV & 99GHSV

PART NO.	HOSE THREAD	PIPE THREAD	C HEX	L	M	FLOW DIA. D
98GHSV-12-8	3/4	1/2	1	1.27	1.21	.687
99GHSV-12-12	3/4	3/4	1-3/16	1.34	1.21	.687

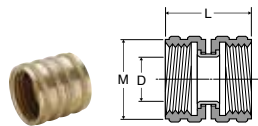

Swivel Nut Connector 101GHSV

PART NO.	HOSE THREAD	L	M	FLOW DIA. D
101GHSV-12	3/4	1.25	1.15	.625



Rubber Garden Hose Coupling Washer 901GH

PART NO.	HOSE THREAD
901GH-12	3/4

NOTE: All female connector ends should have this rubber washer

Hydraulic Quick Couplings/ High Flow Couplings

Applications

Parker Water Service Couplings are used anywhere water hoses are connected and disconnected frequently. They are used on a wide variety of applications including garden hoses, wash down systems, and mobile water tank lines. The unvalved design permits maximum flow with minimum pressure drop.

Features

- Brass and stainless steel construction for heavy duty service.
- Durable 4-ball locking mechanism for secure connections.
- Quality, temperature-resistant nitrile seals for a leak-free service life.

Specifications

- Body Size 3/4"
- Rated Pressure PSI 200 (13.7 bar)
- Rated Flow GPM 28
- Temperature Range (std seals) -40° to +250° F (-40° to 121.1° C)

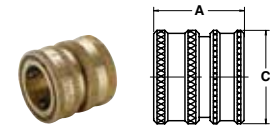

High Flow Coupler 1163-60-BPD

PART NO.	BODY SIZE	THREAD SIZE NH	A	C
1163-60-BPD	3/4	3/4-11 1/2	1.12	1.21

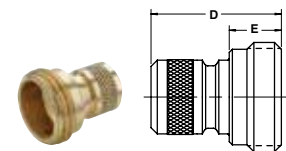

High Flow Nipple 1163-61-BPD

PART NO.	BODY SIZE	THREAD SIZE NH	D	E
1163-61-BPD	3/4	3/4-11 1/2	1.25	.5

WARNING These products can expose you to chemicals including CARBON BLACK, or LEAD, which are known to the state of California to cause cancer, and LEAD which is known to cause birth defects or other reproductive harm. For more information go to www.P65Warnings.ca.gov.





Industrial Valves

Ball Valves

Replacement Componentry

Ball Valve Stem Extensions
Series STX

Needle Valves

















Drain Cocks/
Ground Plug Shutoff











































Female Ports	V500P Female-Female	V502P Panel Mount	V520P Economy Series	V533P 3 Way Diversion	V540P 4 Way	V600P 6 Port Diversion
	 p. K8	 p. K13	 p. K19	 p. K21	 p. K21	 p. K26
V633P 6 Port Diversion	V500CS Carbon Steel	V502CS Panel Mount Carbon Steel	V502SS Panel Mount Stainless	MV709 Micro Valve	MV200 Mini Valve	MV609 Mini Valve
 p. K26	 p. K28	 p. K28	 p. K36	 p. K37	 p. K39	 p. K39
4203 Axial Valve-NPT	4202 Axial Valve-BSP	PV609 Plug Valve	Male-Female Ports	V501P Male-Female	V590P 90° Valve	V590P-X-04 90° Valve
 p. K58	 p. K58	 p. K46		 p. K11	 p. K23	 p. K23
V501SS Stainless Steel	MV708 Micro Valve	MV608 Mini Valve	PV608 Plug Valve	Solder Ports	V509P Solder - Solder	
 p. K34	 p. K37	 p. K39	 p. K46		 p. K16	
Male-Male Ports	V591P 90° Valve	V591P-X-04 90° Valve	PV607 Plug Valve	Straight Thread Ports	V506P Female - Female	V510P Male - Female
	 p. K23	 p. K23	 p. K46		 p. K15	 p. K18
V506CS Carbon Steel	Straight Thread Ports-High Pressure	V506HP Straight Thread	Female Ports-High Pressure	V500HP Female Ports	Female Ports-Padlocking-High Pressure	VP500HP Female Ports-Padlocking
 p. K30		 p. K33		 p. K32		 p. K32
Barb to Female Port	V500HB Barb to Female Port	Padlocking	VP500P Female Ports	VP501P Male - Female	VP502P Panel Mount	VP510P Straight Thread
	 p. K24		 p. K8	 p. K11	 p. K13	 p. K18
VP500CS Carbon Steel	VP502CS Panel Mount	VP502SS Stainless Steel	Straight Thread Ports-Padlocking-High Pressure	VP506HP Straight Thread		
 p. K28	 p. K28	 p. K36		 p. K33		

WARNING These products can expose you to chemicals including NICKEL, CARBON BLACK, or LEAD, which are known to the state of California to cause cancer, and LEAD which is known to cause birth defects or other reproductive harm. For more information go to www.P65Warnings.ca.gov.

Vented	VV500P Female Ports  p. K8	VV501P Male-Female  p. K11	VV502P Panel Mount  p. K13	Vented-Padlocking	VVP500P Female Ports  p. K8	VVP501P Male-Female  p. K11		
	VVP502P Panel Mount  p. K13	Polypropylene Ball Valves			VME Male Elbow  p. K41	VFE Female Elbow  p. K41	VUC Union Connector  p. K41	VEU Elbow Union  p. K41
VFC Female Connector  p. K41	VUCPB Union Connector  p. K42	VAS Angle Stop  p. K42	VME Male Elbow  p. K42	VFE Female Elbow  p. K42	VUC Union Connector  p. K42	VEU Elbow Union  p. K42		
VMC Male Connector  p. K43	VFC Female Connector  p. K43	VTEU Tube Elbow Union  p. K43	VFC Barbed Female Connector  p. K43	VFE Barbed Female Elbow  p. K43	VMC Barbed Male Connector  p. K43	VME Barbed Male Elbow  p. K44		
VUC Barbed Union Connector  p. K44	VUCPB Union Connector Barbed x Tube  p. K44	BVC Ball Valve Clip  p. K44	Tee Handle	V500P-X-04 Female Ports  p. K9	V501P-X-04 Male - Female  p. K11	V502P-X-04 Panel Mount  p. K13		
V510P-X-04 Straight Thread  p. K18	V500CS-X-04 Carbon Steel  p. K28	Oval Handle		V500P-X-21 Female Ports  p. K9	V501P-X-21 Male - Female  p. K11	V502P-X-21 Panel Mount  p. K13	V510P-X-21 Straight Thread  p. K18	
V500CS-X-21 Carbon Steel  p. K29	V502CS-X-21 Panel Mount - Carbon Steel  p. K29		V502SS-X-21 Oval Handle  p. K36	Short Handle	V502SS-X-20 Panel Mount  p. K36			
Metric Female Ports	BVGL Female Ports Long  p. K51	BVGL Female Ports Long  p. K51	MBVG Compact  p. K55					

WARNING These products can expose you to chemicals including NICKEL, CARBON BLACK, or LEAD, which are known to the state of California to cause cancer, and LEAD which is known to cause birth defects or other reproductive harm. For more information go to www.P65Warnings.ca.gov.

Metric Padlocking	BVG4PLOCK Female Ports	Needle Valves	NV101F Female - Male	NV102F Flare	NV103F Flare - Male Pipe	NV104C- NV104CA Compression - Pipe
	 p. K53		 p. K63	 p. K63	 p. K63	 p. K63
NV105C- NV105CA Compression	NV106C- NV106CA Compression - Pipe	NV107P Pipe	NV108P Female - Male	NV109P Female	NV311P Poly-Tite	NV312P Poly-Tite
 p. K63	 p. K64	 p. K64	 p. K64	 p. K64	 p. K64	 p. K64
Shutoff Valves	V203F Flare	V204F Flare - Pipe	V303C-V303CA Compression	V304C-V304CA Compression - Pipe	V401P Pipe	V402P Female - Pipe
	 p. K66	 p. K66	 p. K66	 p. K66	 p. K66	 p. K66
V403P Female	V406P 3 Way	V407P 4 Way	DC601 Pipe	Drain Cocks	DCR601 Internal Seal	DC602 Internal Seal
 p. K66	 p. K66	 p. K66	 p. K66		 p. K67	 p. K67
DC603 Internal Seal	DC604 External Seal	DC606 External Seal	DC607 Bib Drain	Auxiliary	V502P-X-ACT Actuator	V502SS-X-ACT Actuator
 p. K67	 p. K67	 p. K67	 p. K67		 p. K48	 p. K48
V502P-X-SUB Sub-Assembly	V502SS-X-SUB Sub-Assembly	ACT-P-X-KIT Brass Actuator kit	ACT-SS-X-KIT Stainless Actuator Kit	STX-P Stem Extension	PVMB-001 Mounting Bracket	HV104C-KIT Humidifier Valve Kit
 p. K49	 p. K49	 p. K49	 p. K49	 p. K61	 p. K46	 p. K63
SPV104C-KIT Self Piercing Kit	HV104C Humidifier Valve					
 p. K63	 p. K63					

WARNING These products can expose you to chemicals including NICKEL, CARBON BLACK, or LEAD, which are known to the state of California to cause cancer, and LEAD which is known to cause birth defects or other reproductive harm. For more information go to www.P65Warnings.ca.gov.

Ball Valves

Brass Series 500



Parker's industrial ball valves are intended for general purpose use. Ball valves are intended for use in the fully open or closed positions. Throttling of the valve may result in premature seal failure and/or inability to turn the valve handle.

Product Features:

- Forged brass body
- Chrome plated brass ball
- PTFE seats/seals
- Steel handle

Style:

- V-Valve
- VP-Valve, padlocking handle
- VV-Valve, vented
- VVP-Valve, vented, padlocking handle

Type:

- 500-Female/Female PTF ports

Material:

- P-Brass
- PN-Nickel plated

Options:

- 01-Stainless Steel Ball & Stem
- 02-Stainless Steel Handle & Nut
- 03-Stainless Steel Ball, Stem, Handle & Nut
- 04-Tee Handle
- 08-Unmarked yellow vinyl handle cover
- 21-Oval Handle

Specifications:

Pressure Range:

- 600 WOG , Cold Non-shock
- Saturated Steam up to 150 PSI (10.3 bar)
- Vacuum Service to 29 Inches Hg
- Vented up to 250 PSI (17.2 bar)

Temperature Range

- 0° to +350° F (-17.7° to +176.6° C)

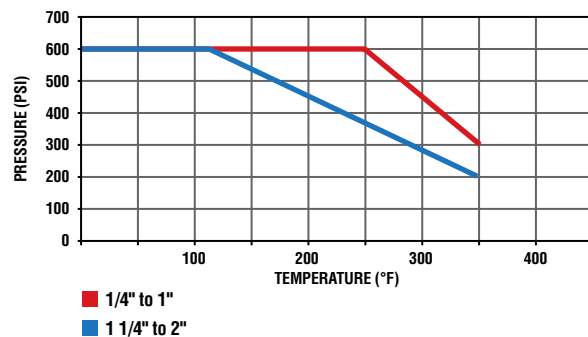

FLOW DATA	
VALVE SIZE	CV
1/4	4.0
3/8	5.8
1/2	12.0
3/4	25.0
1	35.0
1-1/4*	57.0
1-1/2*	92.0
2*	224.0

*For these part numbers only the * options are available.

WARNING These products can expose you to chemicals including NICKEL or LEAD, which are known to the state of California to cause cancer, and LEAD which is known to cause birth defects or other reproductive harm. For more information go to www.P65Warnings.ca.gov.



Female-Female Pipe Ends V500P

PART NO.	PIPE THREAD [PTF]	B HEX	C HEX	H	L	M	N	FLOW DIA. D
V500P-4	1/4	15/16	15/16	3.96	4.90	2.03	2.47	.375
V500P-6	3/8	15/16	15/16	3.96	4.90	2.03	2.47	.375
V500P-8	1/2*	1-1/16	1-1/16	3.96	5.00	2.20	2.58	.500
V500P-12	3/4**	1-1/4	1-5/16	3.96	5.25	2.42	2.81	.685
V500P-16	1**	1-1/2	1-9/16	3.96	5.34	2.75	3.08	.875

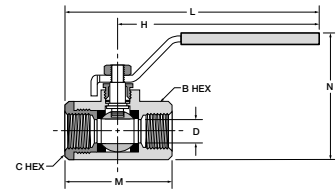

Female-Female Pipe Ends V500P-20, V500P-24, V500P-32

PART NO.	PIPE THREAD [NPT]	OCTAGON	H	L	M	N	FLOW DIA. D
V500P-20	1-1/4	1.93	6.22	8.05	3.66	3.01	1.18
V500P-24	1-1/2	2.13	6.22	8.23	4.02	3.25	1.50
V500P-32	2	2.69	6.22	8.58	4.76	3.52	1.89

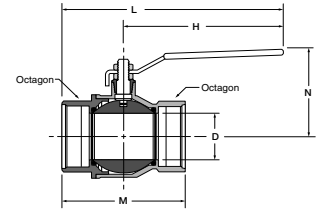

Vented, Female Pipe Ends VV500P

PART NO.	PIPE THREAD [PTF]	B HEX	C HEX	K	H	L	M	N	D FLOW Ø
VV500P-4	1/4	15/16	15/16	1.11	3.96	4.90	2.03	2.47	.375
VV500P-6	3/8	15/16	15/16	1.11	3.96	4.90	2.03	2.47	.375
VV500P-8	1/2*	1-1/16	1-1/16	1.23	3.96	5.00	2.20	2.58	.500
VV500P-12	3/4**	1-1/4	1-5/16	1.45	3.96	5.25	2.42	2.81	.685
VV500P-16	1**	1-1/2	1-9/16	1.58	3.96	5.34	2.75	3.08	.875

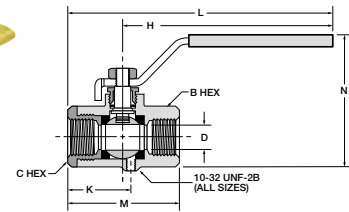

Locking Handle, Female Pipe Ends VP500P

PART NO.	PIPE THREAD [PTF]	B HEX	C HEX	H	L	M	N	D FLOW Ø
VP500P-4	1/4	15/16	15/16	3.96	4.90	2.03	2.47	.375
VP500P-6	3/8	15/16	15/16	3.96	4.90	2.03	2.47	.375
VP500P-8	1/2*	1-1/16	1-1/16	3.96	5.00	2.20	2.58	.500
VP500P-12	3/4**	1-1/4	1-5/16	3.96	5.25	2.42	2.81	.685
VP500P-16	1**	1-1/2	1-9/16	3.96	5.34	2.75	3.08	.875
FOR USE WITH 5/16" Ø SHANK LOCK; .330								
VP500P-20	1-1/4	1-15/16	1-15/16	6.22	8.05	3.66	4.04	1.180
VP500P-24	1-1/2	2-1/8	2-1/8	6.22	8.23	4.02	4.52	1.500
VP500P-32	2	2-11/16	2-11/16	6.22	8.60	4.76	5.07	1.890
FOR USE WITH 9/32" Ø SHANK LOCK; .310								

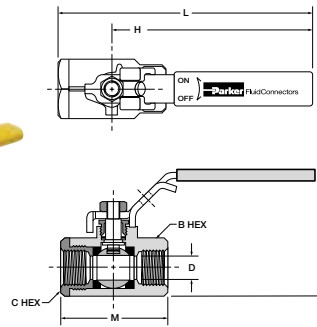

OSHA 29 CFR Part 1910 Vented, Locking Handle, Female Pipe Ends VVP500P

PART NO.	PIPE THD [PTF]	B HEX	C HEX	K	H	L	M	N	D FLOW Ø
VVP500P-4	1/4	15/16	15/16	1.11	3.96	4.90	2.03	2.47	.375
VVP500P-6	3/8	15/16	15/16	1.11	3.96	4.90	2.03	2.47	.375
VVP500P-8	1/2*	1-1/16	1-1/16	1.23	3.96	5.00	2.20	2.58	.500
VVP500P-12	3/4**	1-1/4	1-5/16	1.45	3.96	5.25	2.42	2.81	.685
VVP500P-16	1**	1-1/2	1-9/16	1.58	3.96	5.34	2.75	3.08	.875
FOR USE WITH 5/16" Ø SHANK LOCK									

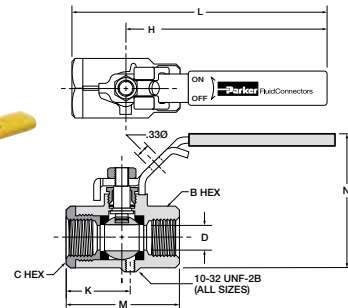

*PTF Special Short. **PTF SPL Extra Short

WARNING These products can expose you to chemicals including NICKEL or LEAD, which are known to the state of California to cause cancer, and LEAD which is known to cause birth defects or other reproductive harm. For more information go to www.P65Warnings.ca.gov.

Tee Handle, Female Pipe Ends V500P-X-04

PART NO.	PIPE THREAD (PTF)	B HEX	C HEX	H	L	M	N	D FLOW Ø
V500P-4-04	1/4	15/16	15/16	1.25	2.50	2.03	1.87	.375
V500P-6-04	3/8	15/16	15/16	1.25	2.50	2.03	1.87	.375
V500P-8-04	1/2*	1-1/16	1-1/16	1.25	2.50	2.20	1.98	.500
V500P-12-04	3/4**	1-1/4	1-5/16	1.25	2.50	2.42	2.20	.685
V500P-16-04	1**	1-1/2	1-9/16	1.25	2.50	2.75	2.48	.875

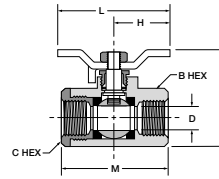

Oval Handle, Female Pipe Ends V500P-X-21

PART NO.	PIPE THREAD (PTF)	B HEX	C HEX	H	L	M	N	D FLOW Ø
V500P-4-21	1/4	15/16	15/16	1.74	3.49	2.03	2.38	.375
V500P-6-21	3/8	15/16	15/16	1.74	3.49	2.03	2.38	.375
V500P-8-21	1/2*	1-1/16	1-1/16	1.74	3.49	2.20	2.49	.500
V500P-12-21	3/4**	1-1/4	1-5/16	1.74	3.48	2.42	2.71	.685
V500P-16-21	1**	1-1/2	1-9/16	1.74	3.48	2.75	2.99	.875

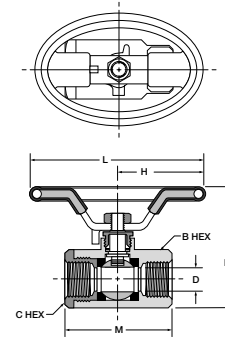

*PTF Special Short. **PTF SPL Extra Short

WARNING These products can expose you to chemicals including NICKEL or LEAD, which are known to the state of California to cause cancer, and LEAD which is known to cause birth defects or other reproductive harm. For more information go to www.P65Warnings.ca.gov.



Ball Valves

Brass Series 501



Product Features:

- Forged brass body
- Chrome plated brass ball
- PTFE seats/seals
- Steel handle

Style:

- V-Valve
- VP-Valve, padlocking handle
- VV-Valve, vented
- VVP-Valve, vented, padlocking handle

Type:

- 501-Male/Female PTF ports

Material:

- P-Brass
- PN-Nickel plated

Options:

- 01-Stainless Steel Ball & Stem
- 02-Stainless Steel Handle & Nut
- 03-Stainless Steel Ball, Stem, Handle & Nut
- 04-Tee Handle
- 08-Unmarked yellow vinyl handle cover
- 21-Oval Handle

Specifications:

Pressure Range:

- 600 WOG , Cold Non-shock
- Saturated Steam up to 150 PSI (10.3 bar)
- Vacuum Service to 29 Inches Hg
- Vented up to 250 PSI (17.2 bar)

Temperature Range

- 0° to +350° F (-17.7° to +176.6° C)

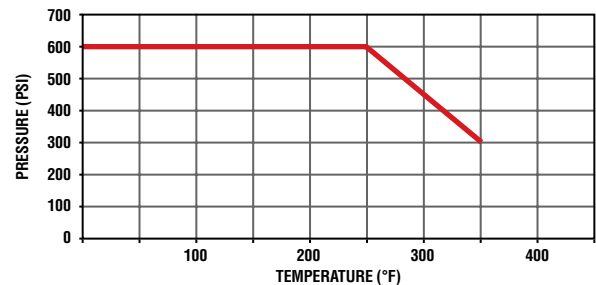

FLOW DATA	
VALVE SIZE	CV
1/4	6.3
3/8	5.7
1/2	10.0
3/4	25.0
1	35.0



WARNING These products can expose you to chemicals including NICKEL or LEAD, which are known to the state of California to cause cancer, and LEAD which is known to cause birth defects or other reproductive harm. For more information go to www.P65Warnings.ca.gov.



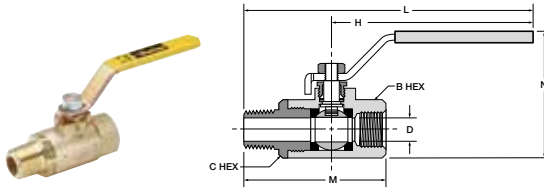

Male-Female Pipe Ends V501P

PART NO.	FEMALE PIPE THRD [PTF]	MALE PIPE THRD [NPTF]	B HEX	C HEX	H	L	M	N	D FLOW Ø
V501P-4	1/4	1/4	15/16	15/16	3.96	5.46	2.59	2.47	.344
V501P-6	3/8	3/8	15/16	15/16	3.96	5.46	2.59	2.47	.375
V501P-8	1/2*	1/2	1-1/16	1-1/16	3.96	5.75	2.94	2.58	.500
V501P-12	3/4**	3/4*	1-1/4	1-5/16	3.96	5.83	3.00	2.81	.685
V501P-16	1**	1*	1-1/2	1-9/16	3.96	6.19	3.60	3.08	.875

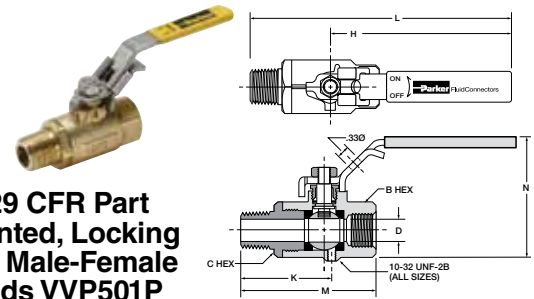

OSHA 29 CFR Part 1910 Vented, Locking Handle, Male-Female Pipe Ends VVP501P

PART NO.	FEMALE PIPE THRD [PTF]	MALE PIPE THRD [NPTF]	B HEX	C HEX	K	H	L	M	N	D FLOW Ø
VVP501P-4	1/4	1/4	15/16	15/16	1.67	3.96	5.46	2.59	2.47	.344
VVP501P-6	3/8	3/8	15/16	15/16	1.67	3.96	5.46	2.59	2.47	.375
VVP501P-8	1/2*	1/2	1-1/16	1-1/16	1.98	3.96	5.75	2.95	2.58	.500
VVP501P-12	3/4**	3/4	1-1/4	1-5/16	2.03	3.96	5.83	3.00	2.81	.685
VVP501P-16	1**	1	1-1/2	1-9/16	2.43	3.96	6.19	3.60	3.08	.875

For use with 5/16" Ø shank lock

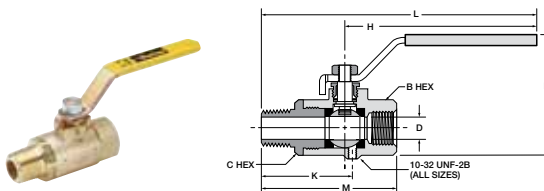

Vented, Male-Female Pipe Ends VV501P

PART NO.	FEMALE PIPE THRD [PTF]	MALE PIPE THRD [NPTF]	B HEX	C HEX	K	H	L	M	N	D FLOW Ø
VV501P-4	1/4	1/4	15/16	15/16	1.67	3.96	5.46	2.59	2.47	.344
VV501P-6	3/8	3/8	15/16	15/16	1.67	3.96	5.46	2.59	2.47	.375
VV501P-8	1/2*	1/2	1-1/16	1-1/16	1.98	3.96	5.75	2.95	2.58	.500
VV501P-12	3/4**	3/4*	1-1/4	1-5/16	2.03	3.96	5.83	3.00	2.81	.685
VV501P-16	1**	1*	1-1/2	1-9/16	2.43	3.96	6.19	3.60	3.08	.875

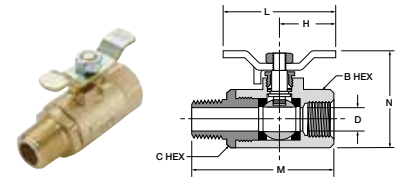

Tee Handle, Male-Female Pipe Ends V501P-X-04

PART NO.	FEMALE PIPE THRD [PTF]	MALE PIPE THRD [NPTF]	B HEX	C HEX	H	L	M	N	D FLOW Ø
V501P-4-04	1/4	1/4	15/16	15/16	1.25	2.50	2.59	1.87	.344
V501P-6-04	3/8	3/8	15/16	15/16	1.25	2.50	2.59	1.87	.375
V501P-8-04	1/2*	1/2	1-1/16	1-1/16	1.25	2.50	2.95	1.98	.500
V501P-12-04	3/4**	3/4	1-1/4	1-5/16	1.25	2.50	3.00	2.20	.685
V501P-16-04	1**	1	1-1/2	1-9/16	1.25	2.50	3.60	2.48	.875

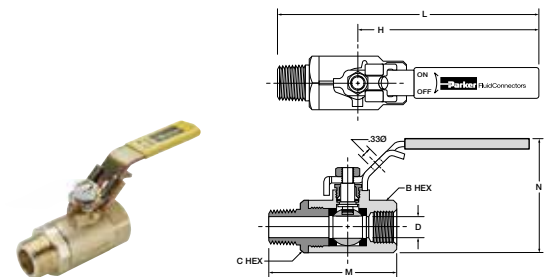

Locking Handle, Male-Female Pipe Ends VP501P

PART NO.	FEMALE PIPE THRD [PTF]	MALE PIPE THRD [NPTF]	B HEX	C HEX	H	L	M	N	D FLOW Ø
VP501P-4	1/4	1/4	15/16	15/16	3.96	5.46	2.59	2.47	.344
VP501P-6	3/8	3/8	15/16	15/16	3.96	5.46	2.59	2.47	.375
VP501P-8	1/2*	1/2	1-1/16	1-1/16	3.96	5.75	2.95	2.58	.500
VP501P-12	3/4**	3/4*	1-1/4	1-5/16	3.96	5.83	3.00	2.81	.685
VP501P-16	1**	1*	1-1/2	1-9/16	3.96	6.19	3.60	3.08	.875

For use with 5/16" Ø shank lock

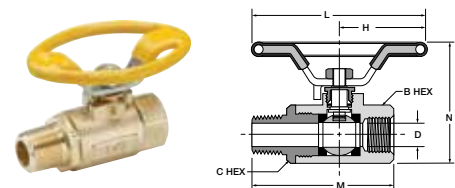

Oval Handle, Male-Female Pipe Ends V501P-X-21

PART NO.	FEMALE PIPE THRD [PTF]	MALE PIPE THRD [NPTF]	B HEX	C HEX	H	L	M	N	D FLOW Ø
V501P-4-21	1/4	1/4	15/16	15/16	1.74	3.49	2.59	2.38	.344
V501P-6-21	3/8	3/8	15/16	15/16	1.74	3.49	2.59	2.38	.375
V501P-8-21	1/2*	1/2	1-1/16	1-1/16	1.74	3.49	2.95	2.49	.500
V501P-12-21	3/4**	3/4	1-1/4	1-5/16	1.74	3.48	3.00	2.71	.685
V501P-16-21	1**	1	1-1/2	1-9/16	1.74	3.48	3.60	2.99	.875

*PTF Special Short. **PTF SPL Extra Short

WARNING These products can expose you to chemicals including NICKEL or LEAD, which are known to the state of California to cause cancer, and LEAD which is known to cause birth defects or other reproductive harm. For more information go to www.P65Warnings.ca.gov.

Ball Valves Brass Series 502



Product Features:

- Forged brass body
- Chrome plated brass ball
- PTFE seats/seals
- Steel handle

Style:

- V-Valve
- VP-Valve, padlocking handle
- VV-Valve, vented
- VVP-Valve, vented, padlocking handle

Type:

- 502-Female/Female PTF ports

Material:

- P-Brass
- PN-Nickel plated

Options:

- 01-Stainless Steel Ball & Stem
- 02-Stainless Steel Handle & Nut
- 03-Stainless Steel Ball, Stem, Handle & Nut
- 04-Tee Handle
- 08-Unmarked yellow vinyl handle cover
- 21-Oval Handle

Specifications:

Pressure Range:

- 600 WOG , Cold Non-shock
- Saturated Steam up to 150 PSI (10.3 bar)
- Vacuum Service to 29 Inches Hg
- Vented up to 250 PSI (17.2 bar)

Temperature Range

- 0° to +350° F (-17.7° to +176.6° C)

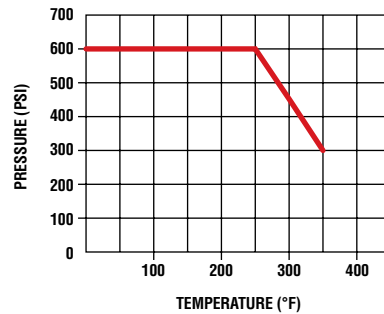

FLOW DATA	
VALVE SIZE	CV
1/4	4.0
3/8	5.8
1/2	12.0
3/4	25.0
1	35.0

Mounting detail for all sizes

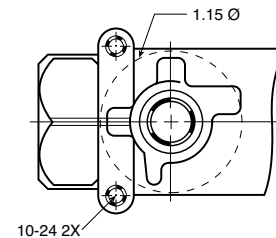

WARNING These products can expose you to chemicals including NICKEL or LEAD, which are known to the state of California to cause cancer, and LEAD which is known to cause birth defects or other reproductive harm. For more information go to www.P65Warnings.ca.gov.



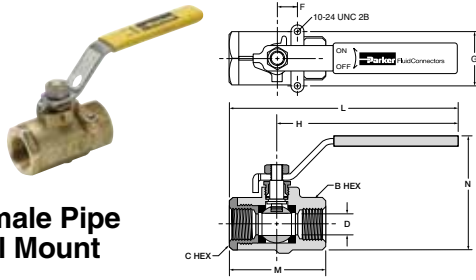

Female-Female Pipe Ends, Panel Mount V502P

PART NO.	PIPE THD. (PTF)	B HEX	C HEX	F	G	H	L	M	N	FLOW DIA. D
V502P-4	1/4	15/16	15/16	.50	1.12	3.96	4.90	2.03	2.47	.375
V502P-6	3/8	15/16	15/16	.50	1.12	3.96	4.90	2.03	2.47	.375
V502P-8	1/2*	1-1/16	1-1/16	.50	1.12	3.96	5.00	2.20	2.58	.500
V502P-12	3/4**	1-1/4	1-5/16	.87	1.37	3.96	5.25	2.42	2.81	.685
V502P-16	1**	1-1/2	1-9/16	.87	1.37	3.96	5.34	2.75	3.08	.875

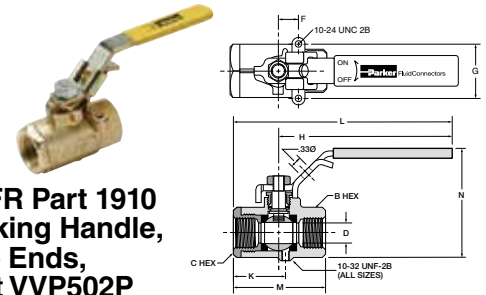

OSHA 29 CFR Part 1910 Vented, Locking Handle, Female Pipe Ends, Panel Mount VVP502P

PART NO.	PIPE THD. (PTF)	B HEX	C HEX	F	G	K	H	L	M	N	D FLOW Ø
VVP502P-4	1/4	15/16	15/16	.50	1.12	1.11	3.96	4.90	2.03	2.47	.375
VVP502P-6	3/8	15/16	15/16	.50	1.12	1.11	3.96	4.90	2.03	2.47	.375
VVP502P-8	1/2*	1-1/16	1-1/16	.50	1.12	1.23	3.96	5.00	2.20	2.58	.500
VVP502P-12	3/4**	1-1/4	1-5/16	.87	1.37	1.45	3.96	5.25	2.42	2.81	.685
VVP502P-16	1**	1-1/2	1-9/16	.87	1.37	1.58	3.96	5.34	2.75	3.08	.875

For use with 5/16" Ø shank lock

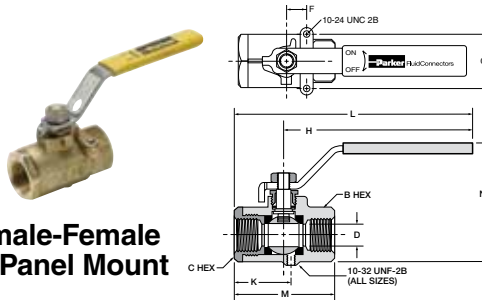

Vented, Female-Female Pipe Ends, Panel Mount VV502P

PART NO.	PIPE THD. (PTF)	B HEX	C HEX	F	G	K	H	L	M	N	D FLOW Ø
VV502P-4	1/4	15/16	15/16	.50	1.12	1.11	3.96	4.90	2.03	2.47	.375
VV502P-6	3/8	15/16	15/16	.50	1.12	1.11	3.96	4.90	2.03	2.47	.375
VV502P-8	1/2*	1-1/16	1-1/16	.50	1.12	1.23	3.96	5.00	2.20	2.58	.500
VV502P-12	3/4**	1-1/4	1-5/16	.87	1.37	1.45	3.96	5.25	2.42	2.81	.685
VV502P-16	1**	1-1/2	1-9/16	.87	1.37	1.58	3.96	5.34	2.75	3.08	.875

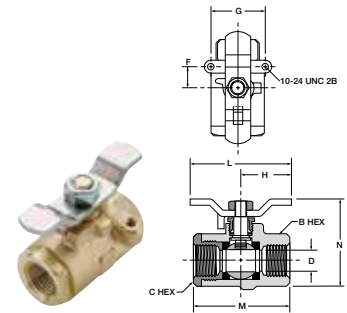

Tee Handle, Female Pipe Ends, Panel Mount V502P-X-04

PART NO.	PIPE THD. (PTF)	B HEX	C HEX	F	G	H	L	M	N	D FLOW Ø
V502P-4-04	1/4	15/16	15/16	.50	1.12	1.25	2.50	2.03	1.87	.375
V502P-6-04	3/8	15/16	15/16	.50	1.12	1.25	2.50	2.03	1.87	.375
V502P-8-04	1/2*	1-1/16	1-1/16	.50	1.12	1.25	2.50	2.20	1.98	.500
V502P-12-04	3/4**	1-1/4	1-5/16	.87	1.37	1.25	2.50	2.42	2.20	.685
V502P-16-04	1**	1-1/2	1-9/16	.87	1.37	1.25	2.50	2.75	2.48	.875

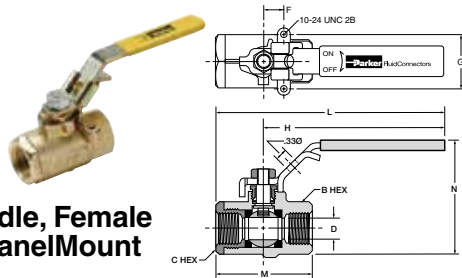

Locking Handle, Female Pipe Ends, Panel Mount VP502P

PART NO.	PIPE THD. (PTF)	B HEX	C HEX	F	G	H	L	M	N	D FLOW Ø
VP502P-4	1/4	15/16	15/16	.50	1.12	3.96	4.90	2.03	2.47	.375
VP502P-6	3/8	15/16	15/16	.50	1.12	3.96	4.90	2.03	2.47	.375
VP502P-8	1/2*	1-1/16	1-1/16	.50	1.12	3.96	5.00	2.20	2.58	.500
VP502P-12	3/4**	1-1/4	1-5/16	.87	1.37	3.96	5.25	2.42	2.81	.685
VP502P-16	1**	1-1/2	1-9/16	.87	1.37	3.96	5.34	2.75	3.08	.875

For use with 5/16" Ø shank lock

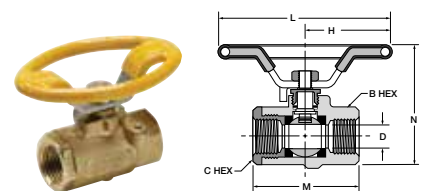

Oval Handle, Female Pipe Ends, Panel Mount V502P-X-21

PART NO.	PIPE THD. (PTF)	B HEX	C HEX	H	L	M	N	D FLOW Ø
V502P-4-21	1/4	15/16	15/16	1.74	3.49	2.03	2.38	.375
V502P-6-21	3/8	15/16	15/16	1.74	3.49	2.03	2.38	.375
V502P-8-21	1/2*	1-1/16	1-1/16	1.74	3.49	2.20	2.49	.500
V502P-12-21	3/4**	1-1/4	1-5/16	1.74	3.48	2.42	2.71	.685
V502P-16-21	1**	1-1/2	1-9/16	1.74	3.48	2.75	2.99	.875

*PTF Special Short. **PTF SPL Extra Short

WARNING These products can expose you to chemicals including NICKEL or LEAD, which are known to the state of California to cause cancer, and LEAD which is known to cause birth defects or other reproductive harm. For more information go to www.P65Warnings.ca.gov.

Ball Valve Brass Series 506



Product Features:

- Forged brass body
- Chrome plated brass ball
- PTFE seats/seals
- Steel handle

Style:

- V-Valve
- VP-Valve, padlocking handle

Type:

- 506-Female/Female SAE J1926-1 Ports

Material:

- P-Brass
- PN-Nickel plated

Options:

- 01-Stainless Steel Ball & Stem
- 02-Stainless Steel Handle & Nut
- 03-Stainless Steel Ball, Stem, Handle & Nut
- 04-Tee Handle
- 08-Unmarked yellow vinyl handle cover
- 21-Oval Handle

Specifications:

Pressure Range:

- 600 WOG , Cold Non-shock
- Saturated Steam up to 150 PSI (10.3 bar)
- Vacuum Service to 29 Inches Hg

Temperature Range

- 0° to +350° F (-17.7° to +176.6° C)

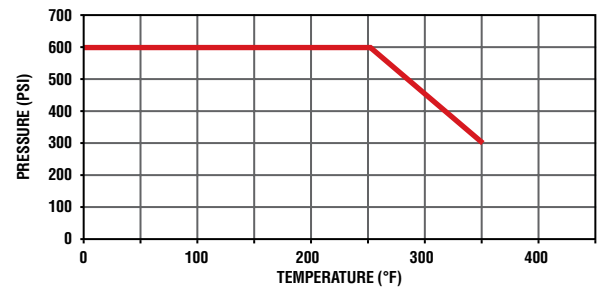

WARNING These products can expose you to chemicals including NICKEL or LEAD, which are known to the state of California to cause cancer, and LEAD which is known to cause birth defects or other reproductive harm. For more information go to www.P65Warnings.ca.gov.

Female/Female, Straight Thread O-Ring Port V506P

PART NO.	STRT. THREAD	B HEX	C HEX	H	L	M	N	D FLOW Ø
V506P-4	7/16-20	15/16	15/16	3.96	5.01	2.20	2.47	.375
V506P-6	9/16-18	15/16	15/16	3.96	5.07	2.26	2.47	.375
V506P-8	3/4-16	1-1/16	1-1/16	3.96	5.18	2.42	2.60	.500
V506P-12	1-1/16-12	1-1/4	1-5/16	3.96	5.87	3.46	2.81	.685
V506P-16	1-5/16-12	1-1/2	1-9/16	3.96	5.96	3.68	3.08	.875

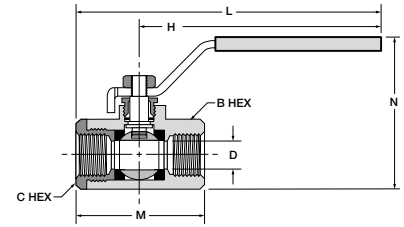

Female/Female, Straight Thread O-Ring Port V506P-20, V506P-24, V506P-32

PART NO.	STRT. THREAD	B OCT	C OCT	H	L	M	N	D FLOW Ø
V506P-20	1 5/8-12	1.93	1.93	6.22	8.05	3.66	3.01	1.18
V506P-24	1 7/8-12	2.13	2.13	6.22	8.23	4.02	3.25	1.50
V506P-32	2 1/2-12	2.85	2.85	6.22	8.60	4.76	3.52	1.89

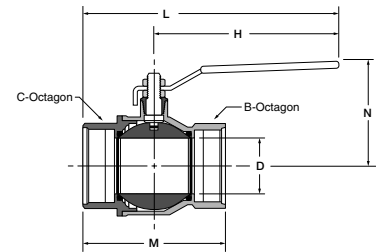

WARNING These products can expose you to chemicals including NICKEL or LEAD, which are known to the state of California to cause cancer, and LEAD which is known to cause birth defects or other reproductive harm. For more information go to www.P65Warnings.ca.gov.



Ball Valves

Brass Series 509



Product Features:

- Forged brass body
- Chrome plated brass ball
- PTFE seats/seals
- Steel handle

Style:

- V-Valve

Type:

- 509-Solder Ends

Material:

- P-Brass

Specifications:

Pressure Range:

- 600 WOG , Cold Non-shock
- Saturated Steam up to 150 PSI (10.3 bar)

Temperature Range

- Nylon: 0° to +350° F (-17.7° to +176.6° C)
- Solder temperature not to exceed 470° F (243.3° C)

Solder Cup Ends V509P

PART NO.	TUBE SIZE	E	G	H	L	M	N	FLOW DIA. D
V509P-8	1/2	.630	.49	3.94	5.00	2.24	1.69	.55
V509P-12	3/4	.877	.75	4.72	6.10	2.85	1.97	.75
V509P-16	1	1.128	.90	4.72	6.40	3.35	2.13	.94
V509P-20	1 1/4	1.378	.96	6.22	8.13	3.82	3.01	1.18
V509P-24	1 1/2	1.628	1.10	6.22	8.46	4.49	3.25	1.50
V509P-32	2	2.128	1.34	6.22	8.94	5.43	3.52	1.89

FLOW DATA	
VALVE SIZE	CV
1/2"	26
3/4"	69
1"	91
1 1/4"	127
1 1/2"	299
2"	425

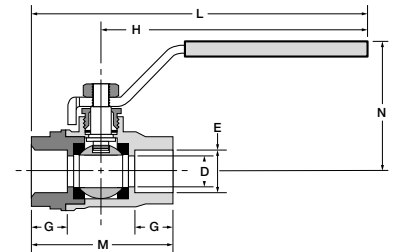

*For these part numbers only the * options are available.

WARNING These products can expose you to chemicals including NICKEL or LEAD, which are known to the state of California to cause cancer, and LEAD which is known to cause birth defects or other reproductive harm. For more information go to www.P65Warnings.ca.gov.



Ball Valves

Brass Series 510



Product Features:

- Forged brass body
- Chrome plated brass ball
- PTFE seats/seals
- Steel handle

Style:

- V-Valve
- VP-Valve, padlocking handle

Type:

- 510-Male/Female Straight Thread O-ring SAE J1926

Material:

- P-Brass

Options:

- 01-Stainless Steel Ball & Stem
- 02-Stainless Steel Handle & Nut
- 03-Stainless Steel Ball, Stem, Handle & Nut
- 04-Tee Handle
- 08-Unmarked yellow vinyl handle cover
- 21-Oval Handle

Specifications:

Pressure Range:

- 600 WOG , Cold Non-shock
- Saturated Steam up to 150 PSI (10.3 bar)
- Vacuum Service to 29 Inches Hg
- Vented up to 250 PSI (17.2 bar)

Temperature Range

- 0° to +350° F (-17.7° to +176.6° C)

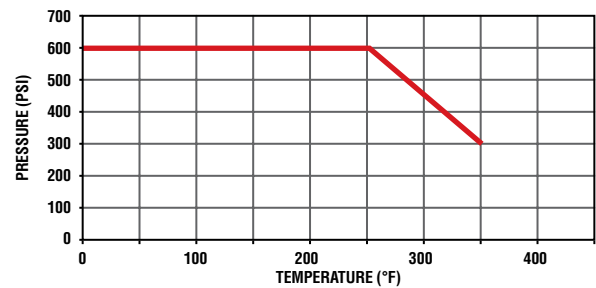

FLOW DATA	
VALVE SIZE	CV
1/4	.8
3/8	2.1
1/2	5.3
5/8	7.6
3/4	13.0
1	33.0



WARNING These products can expose you to chemicals including NICKEL or LEAD, which are known to the state of California to cause cancer, and LEAD which is known to cause birth defects or other reproductive harm. For more information go to www.P65Warnings.ca.gov.



Male-Female, Straight Thread O-Ring Port V510P

PART NO.	STRT. THREAD	B HEX	C HEX	H	L	M	N	D FLOW Ø
V510P-4	7/16-20	15/16	15/16	3.96	5.61	2.85	2.47	.188
V510P-6	9/16-18	15/16	15/16	3.96	5.68	2.92	2.47	.281
V510P-8	3/4-16	1-1/16	1-1/16	3.96	5.88	3.17	2.58	.422
V510P-10	7/8-14	1-1/4	1-5/16	3.96	6.31	3.90	2.81	.500
V510P-12	1-1/16-12	1-1/4	1-5/16	3.96	6.44	4.03	2.81	.656
V510P-16	1-5/16-12	1-1/2	1-9/16	3.96	6.56	4.28	3.08	.875

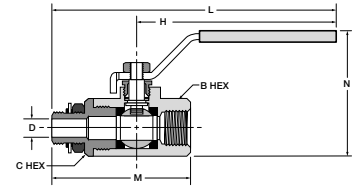

Locking Handle, Straight Thread O-Ring Port VP510P

PART NO.	STRT. THREAD	B HEX	C HEX	H	L	M	N	D FLOW Ø
VP510P-4	7/16-20	15/16	15/16	3.96	5.61	2.85	2.47	.188
VP510P-6	9/16-18	15/16	15/16	3.96	5.68	2.92	2.47	.281
VP510P-8	3/4-16	1-1/16	1-1/16	3.96	5.88	3.17	2.58	.422
VP510P-10	7/8-14	1-1/4	1-5/16	3.96	6.31	3.90	2.81	.500
VP510P-12	1-1/16-12	1-1/4	1-5/16	3.96	6.44	4.03	2.81	.656

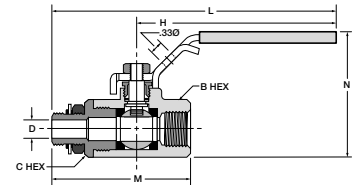

For use with 5/16" Ø shank lock

Tee Handle, Straight Thread O-Ring Port V510P-X-04

PART NO.	STRT. THREAD	B HEX	C HEX	H	L	M	N	D FLOW Ø
V510P-4-04	7/16-20	15/16	15/16	1.25	2.50	2.85	1.87	.188
V510P-6-04	9/16-18	15/16	15/16	1.25	2.50	2.92	1.87	.281
V510P-8-04	3/4-16	1-1/16	1-1/16	1.25	2.50	3.17	1.98	.422
V510P-10-04	7/8-14	1-1/4	1-5/16	1.25	2.50	3.90	2.20	.500
V510P-12-04	1-1/16-12	1-1/4	1-5/16	1.25	2.50	4.03	2.20	.656
V510P-16-04	1-5/16-12	1-1/2	1-9/16	1.25	2.50	4.28	2.48	.875

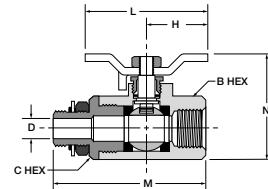

Oval Handle, Straight Thread O-Ring Port V510P-X-21

PART NO.	STRT. THREAD	B & C HEX	H	L	M	N	D FLOW Ø
V510P-4-21	7/16-20	15/16	1.74	3.49	2.85	2.38	.188
V510P-6-21	9/16-18	15/16	1.74	3.49	2.92	2.38	.281
V510P-8-21	3/4-16	1 1/16	1.74	3.49	3.17	2.49	.422
V510P-12-21	1-1/16-12	1-1/4 (B)	1.75	3.49	4.03	2.71	.656
		1-5/16 (C)					

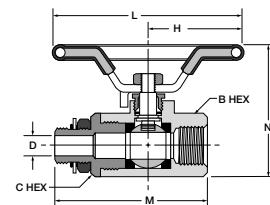

WARNING These products can expose you to chemicals including NICKEL or LEAD, which are known to the state of California to cause cancer, and LEAD which is known to cause birth defects or other reproductive harm. For more information go to www.P65Warnings.ca.gov.

Ball Valves

Brass Series 520



Product Features:

- Forged brass body
- Chrome plated brass ball
- PTFE seats/seals
- Fluorocarbon Stem O-rings
- Steel handle

Style:

- V-Valve

Type:

- 520-Female/Female NPT Ports

Material:

- P-Brass

Options:

- 04-Tee Handle

Specifications:

Pressure Range:

- 600 WOG Cold Non-shock 1/4" – 2"
- 450 WOG, Cold Non-shock 2 1/2" – 3"
- Saturated Steam up to 150 PSI (10.3 bar)
- Vacuum Service to 29 Inches Hg

Temperature Range

- -40° to +350° F (-40° to +176.6° C)

U.L. LISTED	
CATEGORY	
YSDT	LP-GAS SHUT-OFF VALVES
YRBX	FLAMMABLE LIQUID SHUT-OFF VALVES
YRPV	GAS SHUT-OFF VALVES
YQNZ	COMPRESSED GAS SHUT-OFF VALVES

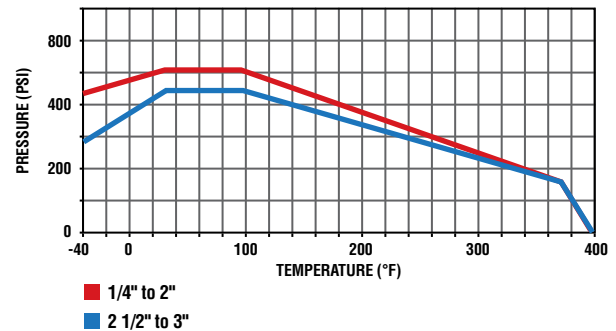

Brass Ball Valve V520P

PART NO.	PIPE THREAD [NPT]	B OCTAGON	C OCTAGON	H	L	M	N	D FLOW Ø
V520P-4	1/4-18	.79	.79	3.94	4.83	1.77	1.50	.310
V520P-6	3/8-18	.79	.79	3.94	4.83	1.77	1.50	.400
V520P-8	1/2-14	.98	.98	3.94	5.10	2.32	1.69	.600
V520P-12	3/4-14	1.22	1.22	4.72	5.98	2.52	1.97	.790
V520P-16	1-11.5	1.57	1.57	4.72	6.32	3.19	2.13	1.000
V520P-20	1-1/4	1.93	1.93	6.22	8.05	3.66	2.82	1.180
V520P-24	1-1/2	2.13	2.13	6.22	8.23	4.02	3.06	1.570
V520P-32	2	2.69	2.69	6.22	8.58	4.76	3.33	2.000
V520P-40	2-1/2	3.35	3.35	10.04	13.11	6.14	5.20	2.520
V520P-48	3	3.89	3.89	10.04	13.52	6.97	5.51	3.000

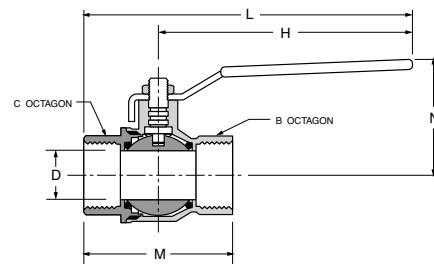

WARNING These products can expose you to chemicals including NICKEL or LEAD, which are known to the state of California to cause cancer, and LEAD which is known to cause birth defects or other reproductive harm. For more information go to www.P65Warnings.ca.gov.





Ball Valves Brass Series 533 3-Way Diversion / Series 540 4-Way

Product Features:

- Forged brass body
- Chrome plated brass ball
- PTFE seats/seals
- Steel handle

Style:

- V-Valve
- VP-Valve, padlocking handle

Type:

- 533 3-Way Diversion
- 540 4-Way

Material:

- P-Brass

Options:

- 02-Stainless Steel Handle & Nut
- 08-Unmarked yellow vinyl handle cover

Specifications:

Pressure Range:

- 400 PSI (27.5 bar)
- Vacuum Service to 29 Inches Hg

Temperature Range

- -20° to +350° F (-6.6° to +176.6° C)

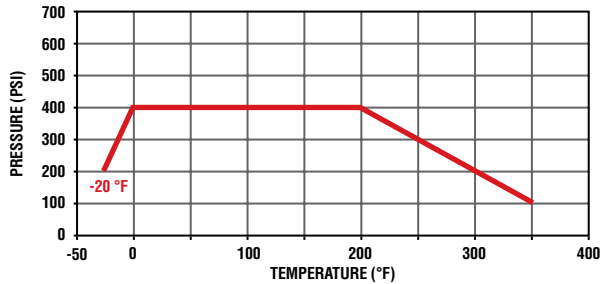

V540P FLOW INFORMATION	
POINTER OVER	FLOW PATH
A	A TO E
OFF	CLOSED
C	C TO E
D	D TO E

V540P Handle Positions

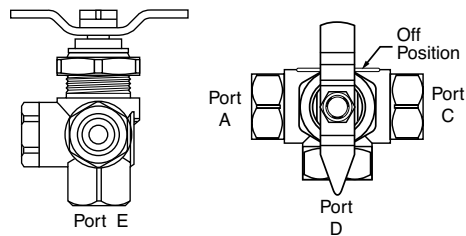

V533P Handle Positions

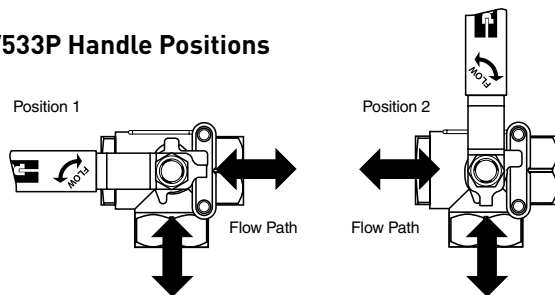

WARNING These products can expose you to chemicals including NICKEL or LEAD, which are known to the state of California to cause cancer, and LEAD which is known to cause birth defects or other reproductive harm. For more information go to www.P65Warnings.ca.gov.

Female-Female-Female Pipe Ends V533P

PART NO.	PIPE THD (PTF)	B HEX	E	F	G	H	K	L	M	N	FLOW DIA. D
V533P-4	1/4	15/16	.50	1.08	1.12	3.96	1.03	2.47	2.03	1.94	.375
V533P-6	3/8	15/16	.50	1.08	1.12	3.96	1.03	2.47	2.03	1.94	.375
V533P-8	1/2	1-1/16	.50	1.18	1.12	3.96	1.11	2.58	2.20	1.98	.500
V533P-12	3/4	1-1/4	.87	1.43	1.37	3.96	1.42	2.90	2.83	2.17	.685
V533P-16	1	1-9/16	.87	1.62	1.37	3.96	1.58	3.21	3.16	2.32	.875

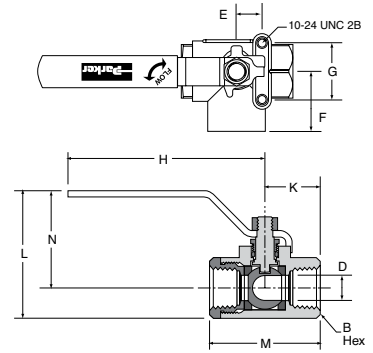

Female-Female-Female-Female Pipe Ends V540P

PART NO.	PIPE THD (PTF)	B HEX	E	F	G	H	K	L	M	N	FLOW DIA. D
V540P-4	1/4	7/8	.32	1.00	1.76	1.25	1.98	2.49	.52	1.07	.250

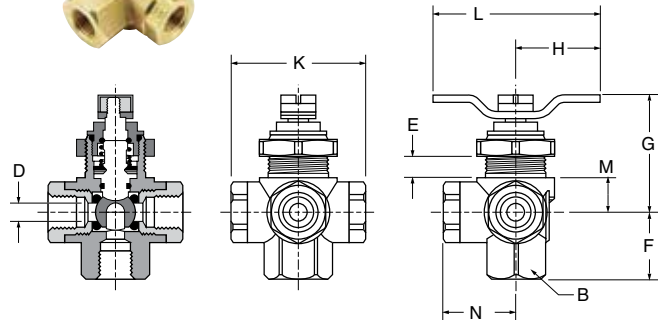

WARNING These products can expose you to chemicals including NICKEL or LEAD, which are known to the state of California to cause cancer, and LEAD which is known to cause birth defects or other reproductive harm. For more information go to www.P65Warnings.ca.gov.

Ball Valves

Brass Series 590/591



Product Features:

- Forged brass body
- Chrome plated brass ball
- PTFE seats/seals
- Steel handle

Style:

- V-Valve

Type:

- 590-Male/Female
- 591-Male/Female

Material:

- P-Brass

Options:

- 04-Lever Handle
- 08-Unmarked yellow vinyl handle cover

Specifications:

Pressure Range:

- 250 PSI (17.2 bar)
- Saturated Steam up to 150 PSI (10.3 bar)
- Vacuum Service to 29 Inches Hg

Temperature Range

- -50° to +350° F (-45.5° to +176.6° C)

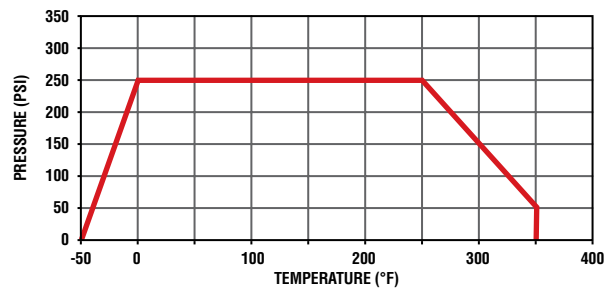

WARNING These products can expose you to chemicals including NICKEL or LEAD, which are known to the state of California to cause cancer, and LEAD which is known to cause birth defects or other reproductive harm. For more information go to www.P65Warnings.ca.gov.



90° Flow, Male-Female Pipe Ends V590P

PART NO.	PIPE PTF THREAD	HEX	H	K	L	M	N	D FLOW Ø
V590P-4	1/4	15/16	1.25	1.08	2.50	1.00	2.42	.375
V590P-6	3/8	15/16	1.25	1.09	2.50	1.00	2.43	.375
V590P-8	1/2*	1-1/16	1.25	1.30	2.50	1.08	2.67	.500
V590P-16	1**	1-9/16"	1.30	1.90	2.60	1.38	3.62	.750

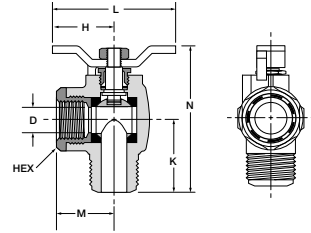

Lever Handle, 90° Flow, Male-Female Pipe Ends V590P-X-04

PART NO.	PIPE PTF THREAD	HEX	H	K	L	M	N	D FLOW Ø
V590P-4-04	1/4	15/16	3.96	1.08	4.96	1.00	3.02	.375
V590P-6-04	3/8	15/16	3.96	1.09	4.96	1.00	3.03	.375
V590P-8-04	1/2*	1-1/16	3.80	1.30	4.88	1.08	2.95	.500
V590P-16-04	1**	1-9/16"	3.96	1.90	5.34	1.38	4.17	.750

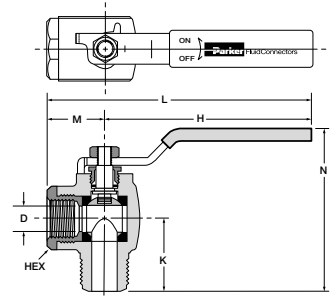

90° Flow, Male-Male Pipe Ends V591P

PART NO.	PIPE THREAD	HEX	H	K	L	M	N	D FLOW Ø
V591P-4	1/4	15/16	1.25	1.08	2.50	1.56	2.42	.375
V591P-6	3/8	15/16	1.25	1.09	2.50	1.56	2.43	.375
V591P-8	1/2	1-1/16	1.25	1.30	2.50	1.84	2.67	.500

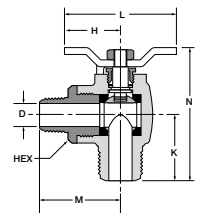

Lever Handle, 90° Flow, Male-Male Pipe Ends V591P-X-04

PART NO.	PIPE THREAD	HEX	H	K	L	M	N	D FLOW Ø
V591P-4-04	1/4	15/16	3.96	1.08	5.52	1.56	3.02	.375
V591P-6-04	3/8	15/16	3.96	1.09	5.52	1.56	3.03	.375
V591P-8-04	1/2	1-1/16	3.80	1.30	5.64	1.84	2.95	.500

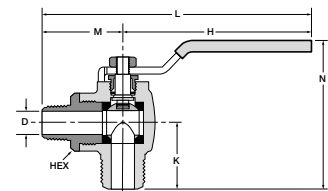

*PTF Special Short. **PTF SPL Extra Short

WARNING These products can expose you to chemicals including NICKEL or LEAD, which are known to the state of California to cause cancer, and LEAD which is known to cause birth defects or other reproductive harm. For more information go to www.P65Warnings.ca.gov.

Ball Valves

Brass Series 500HB



Product Features:

- Forged brass body
- Chrome plated brass ball
- PTFE seats/seals
- Steel handle

Style:

- V-Valve

Type:

- 500HB-Female/Beaded Hose Barb

Material:

- P-Brass

Specifications:

Pressure Range:

- 150 PSI (10.3 bar) WOG, Cold Non-Shock
- Saturated Steam up to 150 PSI (10.3 bar)
- Vacuum Service to 29 Inches Hg

Temperature Range

- 0° to +350° F (-17.7° to +176.6° C)

Brass Hose Barb Ball Valve V500P-HB

PART NO.	PORT 1	PORT 2 PTF	B HEX	C HEX	H	L	M	N	FLOW DIA. D
V500P-12-16HB	1	3/4*	1-1/4	1-5/16	3.96	6.25	3.41	2.81	.685

*PTF special extra short

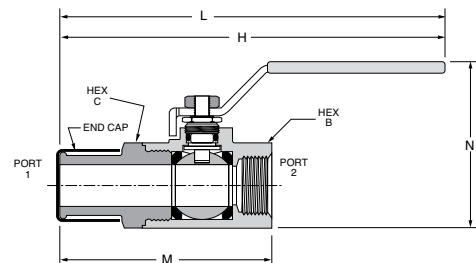

WARNING These products can expose you to chemicals including NICKEL or LEAD, which are known to the state of California to cause cancer, and LEAD which is known to cause birth defects or other reproductive harm. For more information go to www.P65Warnings.ca.gov.



Ball Valves

Brass Series 600



Product Features:

- Forged brass body
- Chrome plated brass ball
- PTFE seats/seals
- Fluorocarbon O-rings
- Steel handle

Style:

- V-Valve

Type:

- 600-Three Position
- 633-Two Position

Material:

- P-Brass

Specifications:

Pressure Range:

- 150 PSI (10.3 bar)
- Vacuum Service to 29 Inches Hg

Temperature Range

- 0° to +250° F (-17.7° to +121.1° C)

Series 600 Handle Positions

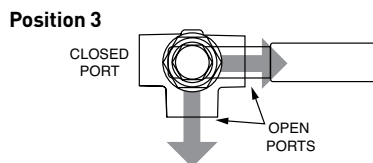
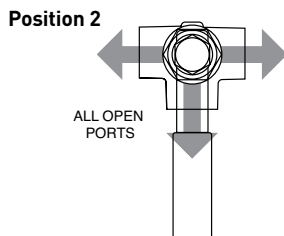
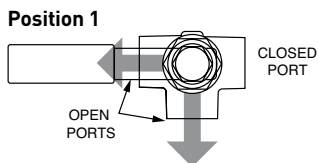

Series 633 Handle Positions

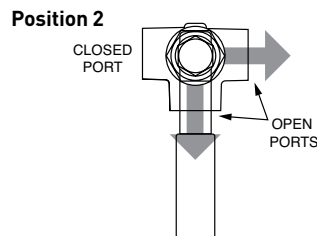
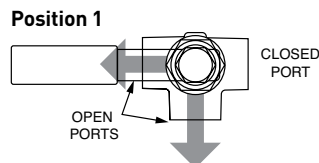

This valve can be used on applications where a fluid return or spillback is required. For use on construction equipment, chemical processing, diesel engines, filter banks, pumps and specialized industrial machinery.

NOTE: Diversion valves do not have off positions, therefore, the center ports can not be used for shut-off purposes.

WARNING These products can expose you to chemicals including NICKEL or LEAD, which are known to the state of California to cause cancer, and LEAD which is known to cause birth defects or other reproductive harm. For more information go to www.P65Warnings.ca.gov.



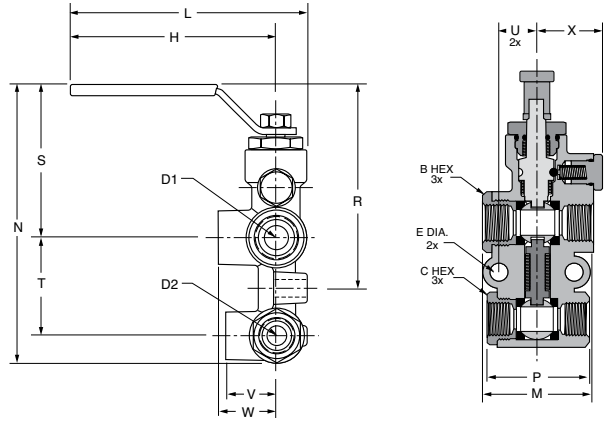

Six Port Diversion Brass Valve V600P

PIPE THD. PART NO.	PIPE THD. TOP PORT SPL SHORT	BOTTOM PORT PTF	B HEX	C HEX	D1 FLOW	D2 FLOW	E	H	L	M	N	P	R	S	T	U	V	W	X
V600P-8-6	1/2	3/8	1 1/16	15/16	.500	.375	.34	3.96	4.56	2.20	5.43	2.03	3.98	2.99	1.91	.73	.98	1.12	1.31

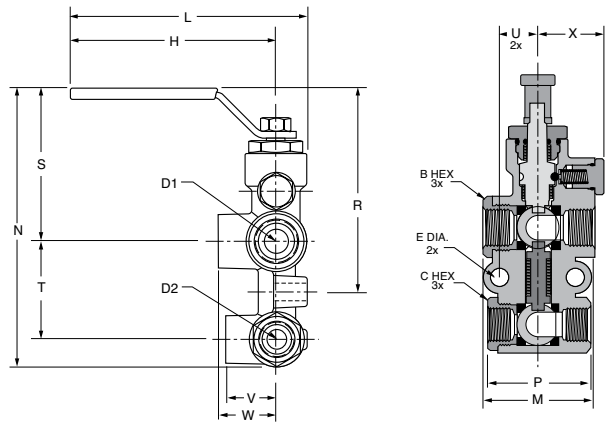

Six Port Diversion Brass Valve V633P

PIPE THD. PART NO.	PIPE THD. TOP PORT SPL SHORT	BOTTOM PORT PTF	B HEX	C HEX	D1 FLOW	D2 FLOW	E	H	L	M	N	P	R	S	T	U	V	W	X
V633P-8-6	1/2	3/8	1 1/16	15/16	.500	.375	.34	3.96	4.56	2.20	5.43	2.03	3.98	2.99	1.91	.73	.98	1.12	1.31

WARNING These products can expose you to chemicals including NICKEL or LEAD, which are known to the state of California to cause cancer, and LEAD which is known to cause birth defects or other reproductive harm. For more information go to www.P65Warnings.ca.gov.



Ball Valves

Carbon Steel Series 500CS/502CS

Product Features:

- Carbon Steel Phosphate Coated body
- Steel ball
- PTFE seats/seals
- Steel handle

Style:

- V-Valve
- VP-Valve, padlocking handle

Type:

- 500-Female/Female
- 502-Female/Female

Material:

- CS-Carbon Steel

Options:

- 04-Tee Handle
- 21-Oval Handle

Specifications:

Pressure Range:

- 1/4" – 1": 2000 PSI (137.8 bar)
- 1 1/4" – 2": 1500 PSI (103.4 bar)
- Saturated Steam up to 150 PSI (10.3 bar)

Temperature Range

- -20° to +425° F (-28.8° to +218.3° C)

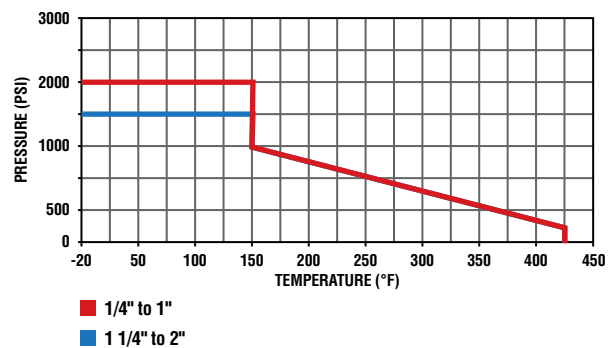

FLOW DATA	
VALVE SIZE	CV
1/4	6.0
3/8	12.8
1/2	15.0
3/4	23.0
1	36.0
1-1/4	44.0
1-1/2	64.0
2	114.0

WARNING These products can expose you to chemicals including NICKEL, which is known to the state of California to cause cancer. For more information go to www.P65Warnings.ca.gov.



Female-Female Pipe Ends V500CS

PART NO.	PIPE THREAD	B HEX	C HEX	H	L	M	N	D FLOW Ø
V500CS-4	1/4	1-1/16	15/16	3.78	1.00	2.00	1.63	.400
V500CS-6	3/8	1-1/16	15/16	3.78	1.00	2.00	1.63	.400
V500CS-8	1/2	1-1/4	1-1/16	3.78	1.25	2.37	1.73	.540
V500CS-12	3/4	1-5/8	1-3/8	5.10	1.50	2.90	2.08	.680
V500CS-16	1	2	1-5/8	5.10	1.76	3.41	2.30	.880

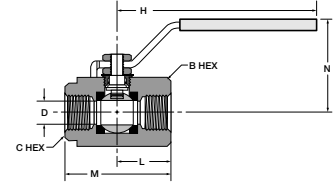

Female-Female Pipe Ends, Panel Mount V502CS

PART NO.	PIPE THD	B HEX	C HEX	F	G	H	L	M	N	FLOW DIA. D
V502CS-20	1-1/4	2	2-1/4	.94	1.50	6.10	1.87	3.80	2.76	1.000
V502CS-24	1-1/2	2-5/16	2-1/2	.94	1.50	6.10	2.27	4.55	2.98	1.250
V502CS-32	2	2-3/4	3	1.03	2.00	8.60	2.42	4.83	3.54	1.500

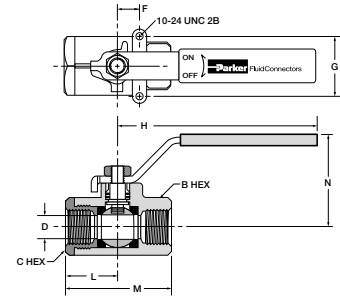

Locking Handle, Female Pipe Ends VP500CS

PART NO.	PIPE THD	B HEX	C HEX	H	L	M	N	D FLOW Ø
VP500CS-4	1/4	1-1/16	15/16	4.13	1.00	2.00	2.23	.400
VP500CS-6	3/8	1-1/16	15/16	4.13	1.00	2.00	2.23	.400
VP500CS-8	1/2	1-1/4	1-1/16	4.13	1.25	2.37	2.33	.540
VP500CS-12	3/4	1-5/8	1-3/8	5.00	1.50	2.90	2.80	.680
VP500CS-16	1	2	1-5/8	5.00	1.76	3.41	2.97	.880

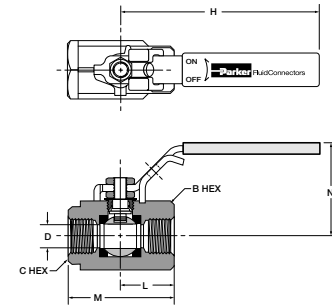

Locking Handle, Female Pipe Ends, Panel Mount VP502CS

PART NO.	PIPE THD	B HEX	C HEX	F	G	H	L	M	N	FLOW DIA. D
VP502CS-20	1-1/4	2	2-1/4	.94	1.50	7.50	1.87	3.80	3.15	1.000
VP502CS-24	1-1/2	2-5/16	2-1/2	.94	1.50	7.50	2.27	4.55	3.37	1.250
VP502CS-32	2	2-3/4	3	1.03	2.00	8.75	2.42	4.83	3.46	1.500

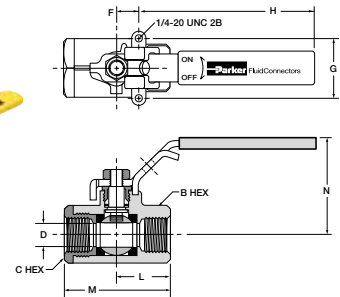

Tee Handle, Female Pipe Ends V500CS-X-04

PART NO.	PIPE THD	B HEX	C HEX	H	L	M	N	D FLOW Ø
V500CS-4-04	1/4	1-1/16	15/16	2.16	1.08	2.00	1.41	.400
V500CS-6-04	3/8	1-1/16	15/16	2.16	1.08	2.00	1.41	.400
V500CS-8-04	1/2	1-1/4	1-1/16	2.90	1.45	2.37	1.66	.540
V500CS-12-04	3/4	1-5/8	1-3/8	3.63	1.81	2.90	2.06	.680
V500CS-16-04	1	2	1-5/8	3.63	1.81	3.41	2.23	.880

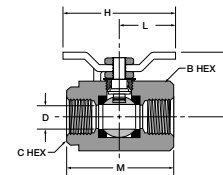

WARNING These products can expose you to chemicals including NICKEL, which is known to the state of California to cause cancer. For more information go to www.P65Warnings.ca.gov.

Oval Handle, Female Pipe Ends V500CS-X-21

PART NO.	PIPE THD	B HEX	C HEX	H	L	M	N	D FLOW Ø
V500CS-4-21	1/4	1-1/16	15/16	3.50	1.00	2.00	1.66	.400
V500CS-6-21	3/8	1-1/16	15/16	3.50	1.00	2.00	1.66	.400
V500CS-8-21	1/2	1-1/4	1-1/16	3.50	1.13	2.37	1.76	.540
V500CS-12-21	3/4	1-5/8	1-3/8	5.00	1.46	2.90	2.13	.680
V500CS-16-21	1	2	1-5/8	5.00	1.58	3.41	2.29	.880

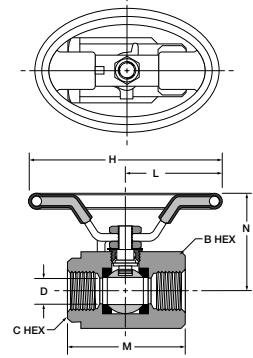

Oval Handle, Female Pipe Ends, Panel Mount V502CS-X-21

PART NO.	PIPE THD	B HEX	C HEX	F	G	H	L	M	N	FLOW DIA. D
V502CS-20-21	1-1/4	2	2-1/4	.94	1.50	5.07	2.53	3.80	3.04	1.000
V502CS-24-21	1-1/2	2-5/16	2-1/2	.94	1.50	5.07	2.53	4.55	3.26	1.250
V502CS-32-21	2	2-3/4	3	1.03	2.00	6.50	3.25	4.83	3.57	1.500

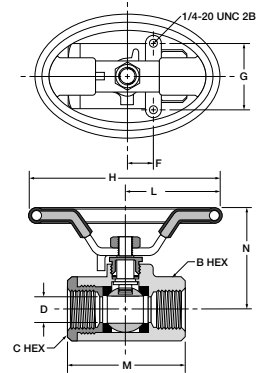

WARNING These products can expose you to chemicals including NICKEL, which is known to the state of California to cause cancer. For more information go to www.P65Warnings.ca.gov.





Ball Valves

Carbon Steel Series 506CS

Product Features:

- Carbon Steel Phosphate Coated body
- Steel ball
- PTFE seats/seals
- Steel handle

Style:

- V-Valve
- VP-Valve, padlocking handle

Type:

- 506-Female/Female SAE Straight Thread Ports

Material:

- CS-Carbon Steel

Options:

- 04-Tee Handle
- 21-Oval Handle

Specifications:

Pressure Range:

- 3000 PSI (206.8 bar)
- Saturated Steam up to 150 PSI (10.3 bar)

Temperature Range

- -20° to +425° F (-28.8° to +218.3° C)

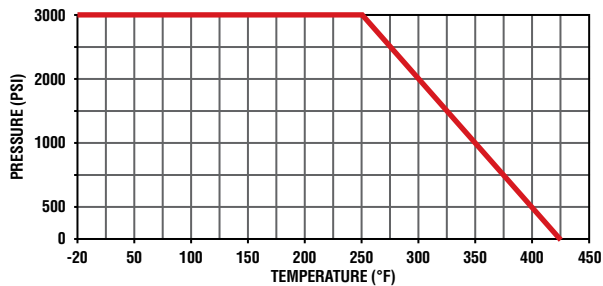

FLOW DATA	
VALVE SIZE	CV
1/4	6.0
3/8	12.0
1/2	15.0
3/4	34.0
1	54.0

Female-Female SAE Straight Thread Ports V506CS

PART NO.	STRAIGHT THREAD	B HEX	C HEX	H	L	M	N	D FLOW Ø
V506CS-4	7/16-20	1-1/16	15/16	3.78	1.00	2.00	1.63	.400
V506CS-6	9/16-18	1-1/16	15/16	3.78	1.00	2.00	1.63	.400
V506CS-8	3/4-16	1-5/8	1-1/4	4.78	1.32	2.84	2.16	.500
V506CS-12	1-1/16-12	1-7/8	1-5/8	4.78	1.66	3.71	2.35	.750
V506CS-16	1-5/16-12	2-1/2	2-1/8	6.10	1.88	4.15	2.85	1.000

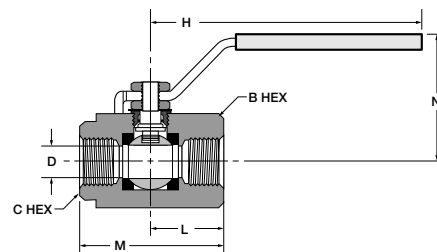

WARNING These products can expose you to chemicals including NICKEL, which is known to the state of California to cause cancer. For more information go to www.P65Warnings.ca.gov.





Ball Valves

Carbon Steel Series 500HP, 506HP

Product Features:

- Carbon Steel Phosphate Coated body
- Steel ball
- Delrin with Molybdenum Disulphide Seats
- Nitrile O-rings Stem Seals
- Steel handle

Style:

- V-Valve
- VP-Valve, padlocking handle

Type:

- 500-Female/Female NPT Ports
- 506-Female/Female SAE Straight Thread Ports

Material:

- HP-High Pressure Carbon Steel

Specifications:

Pressure Range:

- 6000 PSI (413.6 bar)

Temperature Range

- -10° to +210° F (-23.3° to 98.8° C)

Pressure Drop (PSI)

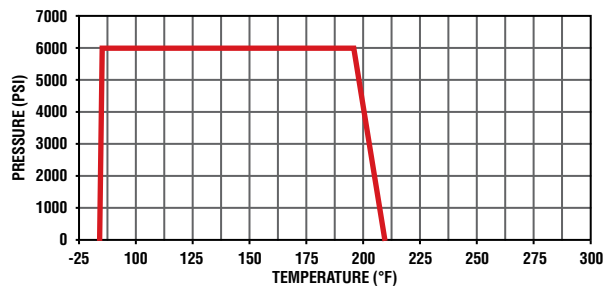
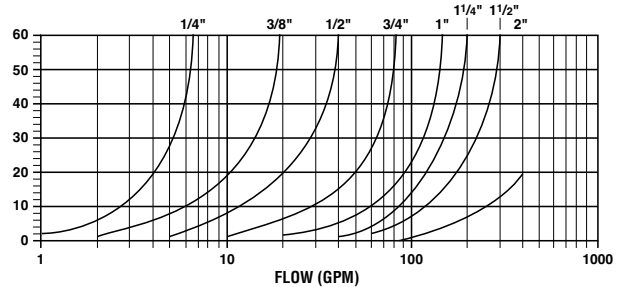

WARNING These products can expose you to chemicals including NICKEL, which is known to the state of California to cause cancer. For more information go to www.P65Warnings.ca.gov.

6000 PSI Female-Female Pipe Ends V500HP-X

PART NO.	PIPE THREAD (NPT)	B	C	H	L	M	N	FLOW DIA. D
V500HP-4	1/4-18	.69	1.38	4.50	1.44	2.75	2.94	.240
V500HP-6	3/8-18	.56	1.50	4.50	1.69	2.88	3.06	.390
V500HP-8	1/2-14	.75	1.63	4.50	1.88	3.38	3.19	.510
V500HP-12	3/4-14	.69	2.25	7.00	2.41	3.81	4.69	.790
V500HP-16	1-11.5	.94	2.50	7.00	2.56	4.50	4.94	.950

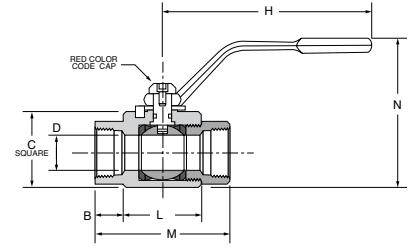

6000 PSI Female-Female Pipe Ends V500HP-X (LARGE)

PART NO.	PIPE THREAD (NPT)	B	C	H	L	M	N	FLOW DIA. D
V500HP-20	1 1/4-11.5	.85	3.25	10.00	3.15	4.84	6.31	1.26
V500HP-24	1 1/2-11.5	.99	3.75	10.00	3.35	5.33	6.76	1.50
V500HP-32	2-11.5	1.30	4.50	10.00	3.94	6.54	7.42	1.89

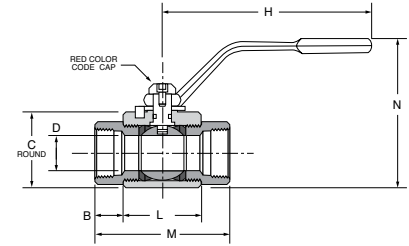

6000 PSI Locking-Female-Female Pipe Ends VP500HP-X

PART NO.	PIPE THREAD (NPT)	B	C	H	L	M	N	FLOW DIA. D
VP500HP-4	1/4-18	.69	1.38	4.50	1.44	2.75	2.94	.240
VP500HP-6	3/8-18	.56	1.50	4.50	1.69	2.88	3.06	.390
VP500HP-8	1/2-14	.75	1.63	4.50	1.88	3.38	3.19	.510
VP500HP-12	3/4-14	.69	2.25	7.00	2.41	3.81	4.69	.790
VP500HP-16	1-11.5	.94	2.50	7.00	2.56	4.50	4.94	.950

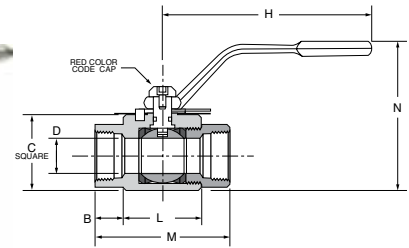

6000 PSI Locking-Female-Female Pipe Ends VP500HP-X (LARGE)

PART NO.	PIPE THREAD (NPT)	B	C	H	L	M	N	FLOW DIA. D
VP500HP-20	1 1/4-11.5	.85	3.25	10.00	3.15	4.84	6.31	1.26
VP500HP-24	1 1/2-11.5	.99	3.75	10.00	3.35	5.33	6.76	1.50
VP500HP-32	2-11.5	1.30	4.50	10.00	3.94	6.54	7.42	1.89

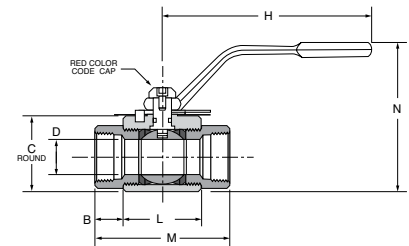

WARNING These products can expose you to chemicals including NICKEL, which is known to the state of California to cause cancer. For more information go to www.P65Warnings.ca.gov.

6000 PSI Female-Female Straight Thread Ends V506HP-X

PART NO.	SAE J1926-1 THREAD	B	C	H	L	M	N	FLOW DIA. D
V506HP-4	7/16-20 UNF	.69	1.38	4.50	1.44	2.75	2.94	.240
V506HP-6	9/16-18 UNF	.56	1.50	4.50	1.69	2.88	3.06	.390
V506HP-8	3/4-16 UNF	.75	1.63	4.50	1.88	3.38	3.19	.510
V506HP-12	1 1/16-12 UNF	.69	2.25	7.00	2.41	3.81	4.69	.790
V506HP-16	1 5/16-12 UNF	.94	2.50	7.00	2.56	4.50	4.94	.950

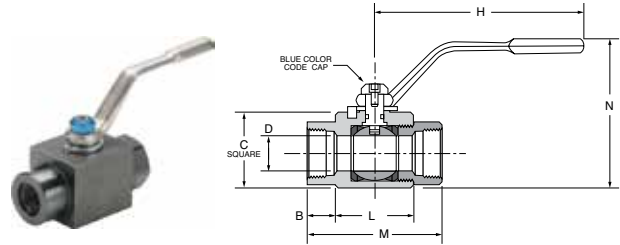

6000 PSI Female-Female Straight Thread Ends V506HP-X (LARGE)

PART NO.	SAE J1926-1 THREAD	B	C	H	L	M	N	FLOW DIA. D
V506HP-20	1 5/8-12 UNF	.85	3.25	10.00	3.15	4.84	6.31	1.26
V506HP-24	1 7/8-12 UNF	.99	3.75	10.00	3.35	5.33	6.76	1.50
V506HP-32	2 1/2-12 UNF	1.30	4.50	10.00	3.94	6.54	7.42	1.89

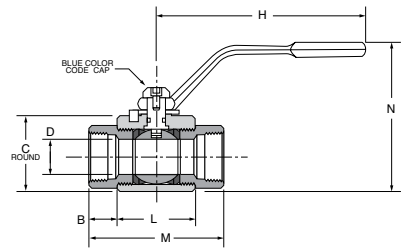

6000 PSI Locking-Female-Female Straight Thread Ends VP506HP-X

PART NO.	SAE J1926-1 THREAD	B	C	H	L	M	N	FLOW DIA. D
VP506HP-4	7/16-20 UNF	.69	1.38	4.50	1.44	2.75	2.94	.240
VP506HP-6	9/16-18 UNF	.56	1.50	4.50	1.69	2.88	3.06	.390
VP506HP-8	3/4-16 UNF	.75	1.63	4.50	1.88	3.38	3.19	.510
VP506HP-12	1 1/16-12 UNF	.69	2.25	7.00	2.41	3.81	4.69	.790
VP506HP-16	1 5/16-12 UNF	.94	2.50	7.00	2.56	4.50	4.94	.950

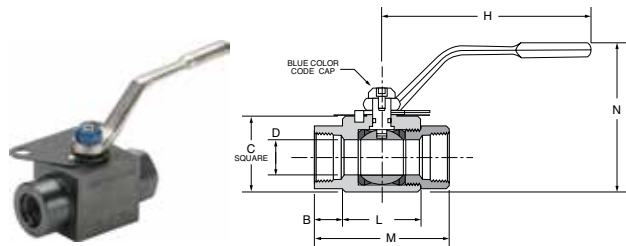

6000 PSI Locking-Female-Female Straight Thread Ends VP506HP-X (LARGE)

PART NO.	SAE J1926-1 THREAD	B	C	H	L	M	N	FLOW DIA. D
VP506HP-20	1 5/8-12 UNF	.85	3.25	10.00	3.15	4.84	6.31	1.26
VP506HP-24	1 7/8-12 UNF	.99	3.75	10.00	3.35	5.33	6.76	1.50
VP506HP-32	2 1/2-12 UNF	1.30	4.50	10.00	3.94	6.54	7.42	1.89

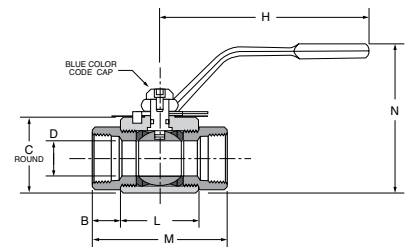

WARNING These products can expose you to chemicals including NICKEL, which is known to the state of California to cause cancer. For more information go to www.P65Warnings.ca.gov.



Ball Valves

Stainless Steel Series 501SS

Product Features:

- CF-8M Stainless Steel body
- Stainless Steel ball
- PTFE Seats/Seals
- Stainless Steel handle
- Silicone Free

Material:

- SS – Stainless Steel

Options

- 20-Short Handle
- 21-Oval Handle
- 35-Welded Retainer Nut

Specifications:

Pressure Range:

- 2000 PSI (137.8 bar)
- Vacuum service 28 inches Hg

Temperature Range

- 0° to +400° F (-17.7° to +204.4° C)

Style:

- V-Valve

Type:

- 501-Male/Female NPT Ports

Approvals

- Meets material requirements of NACE MR-01-75

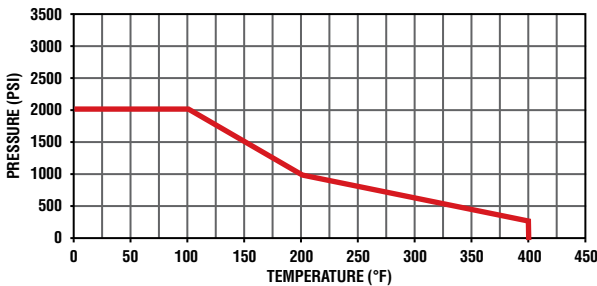

FLOW DATA	
VALVE SIZE	CV
1/4	4.0
3/8	6.0
1/2	14.0
3/4	35.0
1	54.0

Mounting Detail

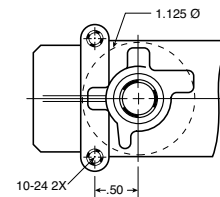

Male-Female Pipe Ends V501SS

PART NO.	PIPE THREAD [NPT]	HEX	F	G	L	M	N	D FLOW Ø
V501SS-4	1/4	15/16	.50	1.12	5.60	2.65	1.97	.280
V501SS-6	3/8	15/16	.50	1.12	5.60	2.65	1.97	.375
V501SS-8	1/2	1-1/16	.50	1.12	5.85	3.05	2.00	.500
V501SS-12	3/4	1-3/8	.88	1.37	7.27	3.85	2.55	.720
V501SS-16	1	1-5/8	.88	1.37	7.48	4.25	2.68	.940

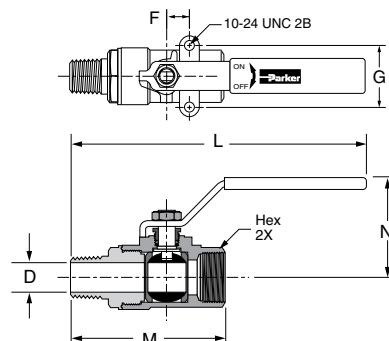

WARNING These products can expose you to chemicals including NICKEL, which is known to the state of California to cause cancer. For more information go to www.P65Warnings.ca.gov.



Ball Valves

Stainless Steel Series 502SS



Product Features:

- CF-8M Stainless Steel body
- Stainless Steel ball
- PTFE Seats/Seals
- Stainless Steel handle
- Silicone Free

Style:

- V-Valve
- VP-Valve, Padlocking

Type:

- 502-Panel Mount Female/
Female NPT Ports

Material:

- SS – Stainless Steel

Options

- 20-Short Handle
- 21-Oval Handle
- 35-Welded Retainer Nut

Specifications:

Pressure Range:

- 1/4" – 1": 2000 PSI (137.8 bar)
- 1 1/4" – 2": 1500 PSI (103.4 bar)
- Vacuum service 28 inches Hg

Temperature Range

- 0° to +400° F (-17.7° to +204.4° C)

Approvals

- Meets material requirements of NACE MR-01-75

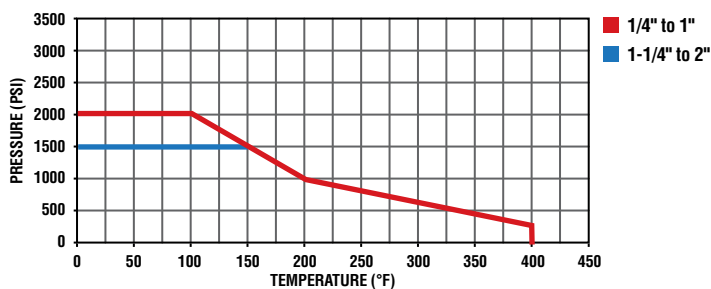

FLOW DATA		MOUNTING HOLE DIAMETER	
VALVE SIZE	CV	VALVE SIZE	DIA. IN.
1/4	4.0	1/4	1.125
3/8	6.0	3/8	1.125
1/2	14.0	1/2	1.125
3/4	35.0	3/4	1.500
1	54.0	1	1.500
1 1/4	74.0	1 1/4	1.875
1 1/2	120.0	1 1/2	1.875
2	226.0	2	1.875

Mounting Detail

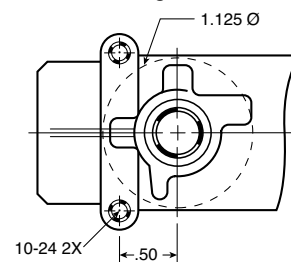

Note: Periodically check the adjustable packing nut and tighten as required.

WARNING These products can expose you to chemicals including NICKEL, which is known to the state of California to cause cancer. For more information go to www.P65Warnings.ca.gov.



Female Pipe Ends, Panel Mount V502SS

PART NO.	PIPE THD (NPT)	B/C HEX	F	G	H	I THREAD	L	M	N	PANEL FLOW DIA. D	HOLE DIA.
V502SS-4	1/4	15/16	.500	1.125	4.00	10-24 UNC	5.03	2.07	2.52	.380	1.125
V502SS-6	3/8	15/16	.500	1.125	4.00	10-24 UNC	5.03	2.07	2.52	.380	1.125
V502SS-8	1/2	1-1/16	.500	1.125	4.00	10-24 UNC	5.13	2.27	2.65	.500	1.125
V502SS-12	3/4	1-3/8	.875	1.375	5.00	10-24 UNC	6.67	3.35	3.46	.790	1.500
V502SS-16	1	1-5/8	.875	1.375	5.00	10-24 UNC	6.77	3.54	3.74	1.000	1.500
V502SS-20	1-1/4	2	1.000	1.500	7.00	1/4-20 UNC	9.00	4.00	4.55	1.250	2.000
V502SS-24	1-1/2	2-3/8	1.000	1.500	7.00	1/4-20 UNC	7.19	4.38	5.42	1.500	2.000
V502SS-32	2	3	1.000	1.500	7.00	1/4-20 UNC	9.75	5.50	5.68	2.000	2.000

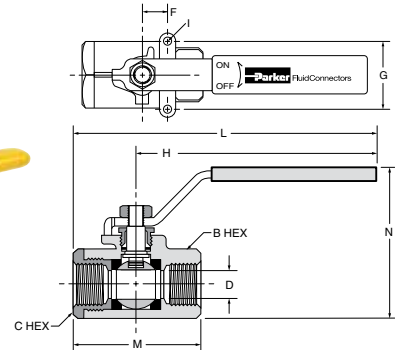

Short Handle, Female Pipe Ends, Panel Mount V502SS-X-20

PART NO.	PIPE THREAD (NPT)	B/C HEX	G	H	L	M	N	FLOW DIA. D
V502SS-4-20	1/4	15/16	1.12	2.28	3.32	2.07	2.53	.375
V502SS-6-20	3/8	15/16	1.12	2.28	3.32	2.07	2.53	.375
V502SS-8-20	1/2	1-1/16	1.12	2.22	3.37	2.25	2.63	.500

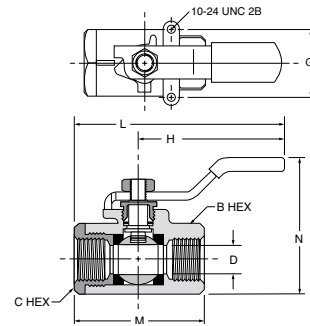

Locking Handle, Female Pipe Ends, Panel Mount VP502SS

PART NO.	PIPE THD (NPT)	B/C HEX	F	G	H	I THREAD	L	M	N	PANEL FLOW DIA. D	HOLE DIA.
VP502SS-4	1/4	15/16	.500	1.125	4.00	10-24 UNC	5.03	2.07	2.52	.380	1.125
VP502SS-6	3/8	15/16	.500	1.125	4.00	10-24 UNC	5.03	2.07	2.52	.380	1.125
VP502SS-8	1/2	1-1/16	.500	1.125	4.00	10-24 UNC	5.13	2.27	2.65	.500	1.125
VP502SS-12	3/4	1-3/8	.875	1.375	5.00	10-24 UNC	6.67	3.35	3.46	.790	1.500
VP502SS-16	1	1-5/8	.875	1.375	5.00	10-24 UNC	6.77	3.54	3.74	1.000	1.500
VP502SS-20	1-1/4	2	1.000	1.500	7.00	1/4-20 UNC	9.00	4.00	4.55	1.250	2.000
VP502SS-24	1-1/2	2-3/8	1.000	1.500	7.00	1/4-20 UNC	7.19	4.38	5.42	1.500	2.000
VP502SS-32	2	3	1.000	1.500	7.00	1/4-20 UNC	9.75	5.50	5.68	2.000	2.000

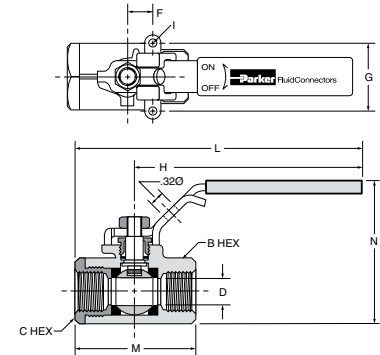

Oval Handle, Female Pipe Ends, Panel Mount V502SS-X-21

PART NO.	PIPE THD (NPT)	B/C HEX	G	H	L	I THREAD	M	N	PANEL FLOW DIA. D	HOLE DIA.
V502SS-4-21	1/4	15/16	1.125	1.74	3.48	10-24 UNC	2.07	2.43	.380	1.125
V502SS-6-21	3/8	15/16	1.125	1.74	3.48	10-24 UNC	2.07	2.43	.380	1.125
V502SS-8-21	1/2	1-1/16	1.125	1.74	3.48	10-24 UNC	2.27	2.54	.500	1.125
V502SS-12-21	3/4	1-3/8	1.375	2.68	5.36	10-24 UNC	3.35	3.45	.790	1.500
V502SS-16-21	1	1-5/8	1.375	2.68	5.36	10-24 UNC	3.54	3.74	1.000	1.500

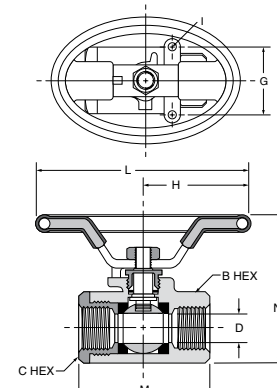

WARNING These products can expose you to chemicals including NICKEL, which is known to the state of California to cause cancer. For more information go to www.P65Warnings.ca.gov.

Ball Valves Micro Series 708/709



Product Features:

- Brass Body
- Chrome Plated Brass Ball
- PTFE Seats/Seals
- Nitrile Stem Seal
- Chrome Plated Steel Handle

Style:

- MV-Micro Valve

Type:

- 708-Male/Female
- 709-Female/Female

Specifications:

Pressure Range:

- Up to 500 PSI (34.4 bar)
- Vacuum service 29 inches Hg

Temperature Range

- -35° to +300° F (-37.2 to +148.8° C)

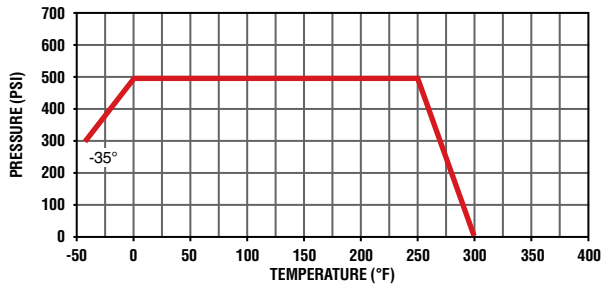

FLOW DATA		
VALVE SIZE	MV708 CV	MV709 CV
1/4	.95	.95

Male-Female Pipe Ends, Mini Ball Valve MV708

PART NO.	PIPE THREAD	B HEX	H	L	M	N	P	FLOW DIA. D
MV708-2	1/8	9/16	1.18	.63	1.62	.93	.38	.180
MV708-4	1/4	11/16	1.52	.70	1.57	.79	.50	.210

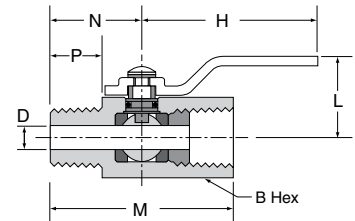

Female Pipe Ends, Mini Ball Valve MV709

PART NO.	PIPE THREAD	B HEX	H	L	M	N	FLOW DIA. D
MV709-2	1/8	9/16	1.18	.63	1.52	.68	.180
MV709-4	1/4	11/16	1.52	.70	1.57	.76	.210

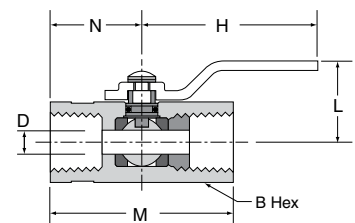

WARNING These products can expose you to chemicals including NICKEL or LEAD, which are known to the state of California to cause cancer, and LEAD which is known to cause birth defects or other reproductive harm. For more information go to www.P65Warnings.ca.gov.





Ball Valves

Mini Series 200/608/609

Product Features:

- Chrome Plated Brass Body
- Chrome Plated Brass Ball
- PTFE Seats/Seals
- Fluorocarbon Stem Seal
- 608/609 Polyamide Wedge Handle
- 200 Polyamide Lever Handle

Style:

- MV-Mini Valve

Type:

- 608-Male/Female
- 609-Female/Female
- 200-Female/Female
- 21-Oval Handle

Specifications:

Pressure Range:

- MV200: 200 PSI (13.7 bar)
- MV608/609: Vacuum Service 28 Inches Hg
- MV608/609: 450 PSI (31.0 bar)

Temperature Range

- 0° to +200° F (-17.7° to +93.3° C)

MV200 Pressure and Temperature

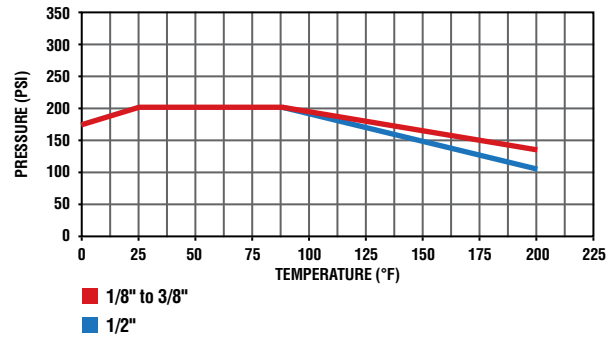

MV608/609 Pressure and Temperature

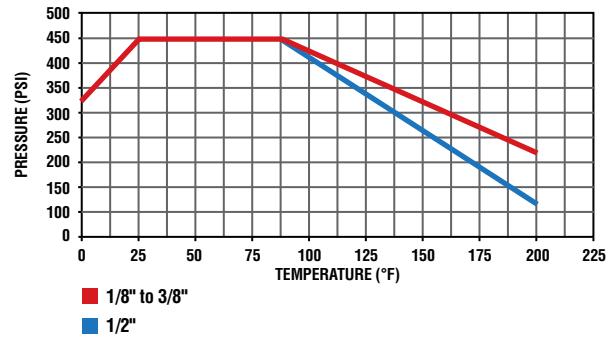

FLOW DATA			
VALVE SIZE	MV200 CV	MV608 CV	MV609 CV
1/8	1.3	1.2	1.4
1/4	4.0	5.8	4.3
3/8	3.7	3.9	3.6
1/2	5.8	5.6	6.0

WARNING These products can expose you to chemicals including NICKEL or LEAD, which are known to the state of California to cause cancer, and LEAD which is known to cause birth defects or other reproductive harm. For more information go to www.P65Warnings.ca.gov.



Female Pipe Ends, Lever Handle, Mini Ball Valve MV200

PART NO.	PIPE THREAD	HEX	B	C	H	L	FLOW DIA. D
MV200-2	1/8	.83	1.71	1.20	.91	2.83	.31
MV200-4	1/4	.83	1.71	1.20	.91	2.83	.31
MV200-6	3/8	.83	1.71	1.20	.91	2.83	.31
MV200-8	1/2	.98	2.11	1.28	1.10	2.83	.39

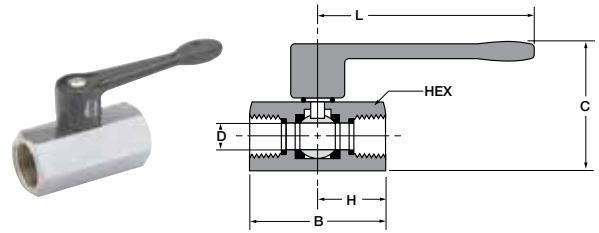

Male-Female Pipe Ends, Compact Handle, Mini Ball Valve MV608

PART NO.	PIPE THREAD	A HEX	B	C	FLOW DIA. D
MV608-2	1/8	.83	1.72	1.22	.20
MV608-4	1/4	.83	1.72	1.22	.31
MV608-6	3/8	.83	1.72	1.22	.31
MV608-8	1/2	.98	2.11	1.30	.39

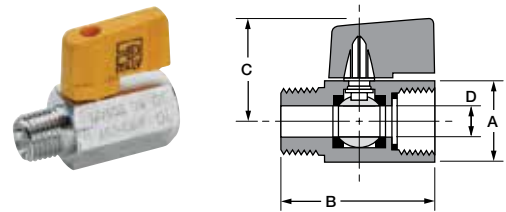

Female Pipe Ends, Compact Handle, Mini Ball Valve MV609

PART NO.	PIPE THREAD	A HEX	B	C	FLOW DIA. D
MV609-2	1/8	.83	1.71	1.22	.24
MV609-4	1/4	.83	1.71	1.22	.31
MV609-6	3/8	.83	1.71	1.22	.31
MV609-8	1/2	.98	2.11	1.30	.39
MV609-6-4	3/8X1/4	.83	1.71	1.22	.31

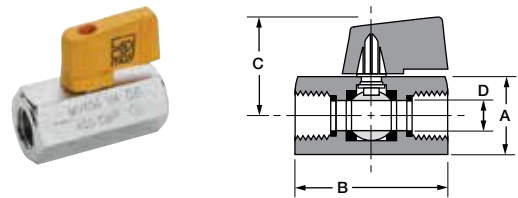

WARNING These products can expose you to chemicals including NICKEL or LEAD, which are known to the state of California to cause cancer, and LEAD which is known to cause birth defects or other reproductive harm. For more information go to www.P65Warnings.ca.gov.



Ball Valves Polypropylene

Parker's Polypropylene Ball Valves offers a corrosion-resistant, all plastic design making them ideal for water filtration units, coffee and beverage machines and a wide variety of other fluid applications.

Product Features:

- Wide chemical acceptance range
- Bi-directional flow maximizes productivity
- Full flow reduces pressure drop across valve
- EPDM seals
- Push-in and barbed connections
- Meets FDA and NSF/ANSI 51 requirements for food contact

Advantages:

- Reduce costs – Built in LIQUIfit, TrueSeal and Par-Barb connections eliminates the need for a secondary fitting.
- Save Space – Low-profile design allows for easy assembly and access where space is a concern.

Type:

- LFPP – LIQUIfit
- PP – TrueSeal
- PBPP – Par-Barb

Specifications:

Pressure Range Up to 150 PSI (10.3 bar)

Temperature Range

LIQUIfit: 35° to +200° F (+1.7° to +93.3° C)

Par-Barb: 35° to +200° F (+1.7° to +93.3° C)

TrueSeal: 0° to +225° F (-17.8° to +107.2° C)

Assembly Instructions

1. Cut tubing squarely – maximum of 15° angle allowable.
2. Check that port or mating part is clean and free of debris.
3. Mark tubing to appropriate tube insertion length. (see Tube Insertion Chart on page N22)
4. Insert tubing until it bottoms
5. Pull on tubing to verify it is fully inserted
6. To disassemble, simply press release button, hold against body and pull tubing out of fitting.



WARNING These products can expose you to chemicals including CARBON BLACK, or LEAD, which are known to the state of California to cause cancer, and LEAD which is known to cause birth defects or other reproductive harm. For more information go to www.P65Warnings.ca.gov.



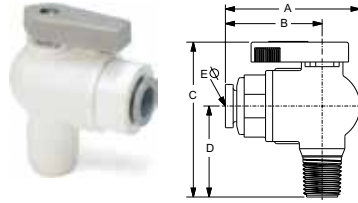

VME - Valve Male Elbow

PART NO.	NOM. TUBE O.D.	NPTF THREAD SIZE	A	B	C	D	ØE THRU HOLE MIN.
LFPP4VME2	1/4	1/8	1.74	1.21	2.00	1.10	.19
LFPP4VME4	1/4	1/4	1.74	1.21	2.18	1.28	.19
LFPP4VME6	1/4	3/8	1.74	1.21	2.18	1.28	.19
LFPP4VME8	1/4	1/2	1.74	1.21	2.37	1.47	.19
LFPP6VME2	3/8	1/8	1.85	1.32	2.00	1.10	.25
LFPP6VME4	3/8	1/4	1.85	1.32	2.18	1.28	.25
LFPP6VME6	3/8	3/8	1.85	1.32	2.18	1.28	.25
LFPP6VME8	3/8	1/2	1.85	1.32	2.37	1.47	.25

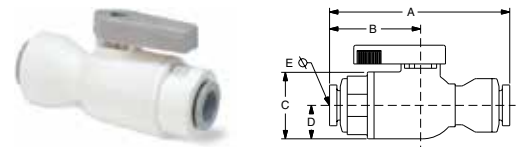

VUC - Valve Union Connector Metric

PART NO.	1 TUBE SIZE MM	2 TUBE SIZE MM	A MM	B MM	C MM	D MM	ØE THRU HOLE MIN. MM
LFPP6MVUC6M	6	6	.57	.27	.36	.13	.19
LFPP8MVUC8M	8	8	.60	.27	.36	.13	.25
LFPP10MVUC10M	10	10	.70	.33	.36	.13	.33
LFPP12MVUC12M	12	12	.88	.43	.36	.13	.37

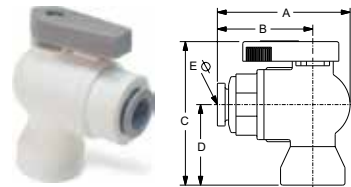

VFE - Valve Female Elbow

PART NO.	NOM. TUBE O.D.	NPTF THREAD SIZE	A	B	C	D	ØE THRU HOLE MIN.
LFPP4VFE2	1/4	1/8	1.74	1.21	1.82	.92	.19
LFPP4VFE4	1/4	1/4	1.74	1.21	2.05	1.15	.19
LFPP4VFE6	1/4	3/8	1.74	1.21	2.18	1.28	.19
LFPP6VFE2	3/8	1/8	1.85	1.32	1.82	.92	.25
LFPP6VFE4	3/8	1/4	1.85	1.32	2.05	1.15	.25
LFPP6VFE6	3/8	3/8	1.85	1.32	2.18	1.28	.25

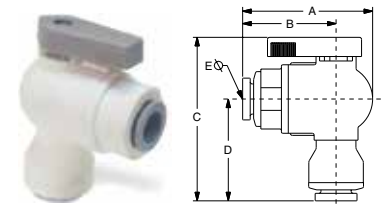

VEU - Valve Elbow Union

PART NO.	1 TUBE SIZE	2 TUBE SIZE	A	B	C	D	ØE THRU HOLE MIN.
LFPP4VEU4	1/4	1/4	1.75	1.22	2.33	1.42	.19
LFPP4VEU6	1/4	3/8	1.75	1.22	2.33	1.42	.11
LFPP6VEU4	3/8	1/4	1.83	1.30	2.32	1.40	.19
LFPP6VEU6	3/8	3/8	1.85	1.32	2.34	1.44	.25

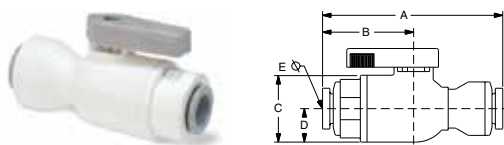

VUC - Valve Union Connector

PART NO.	1 TUBE SIZE	2 TUBE SIZE	A	B	C	D	ØE THRU HOLE MIN.
LFPP4VUC4	1/4	1/4	2.55	1.22	1.0	.5	.19
LFPP4VUC6	1/4	3/8	2.57	1.30	1.0	.5	.19
LFPP6VUC6	3/8	3/8	2.67	1.32	1.4	.5	.25

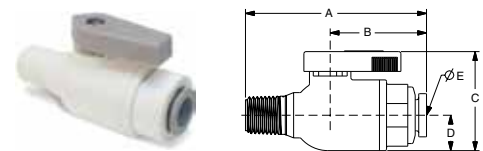

VMC - Valve Male Connector

PART NO.	NOM. TUBE O.D.	NPTF THREAD SIZE	A	B	C	D	ØE THRU HOLE MIN.
LFPP4VMC2	1/4	1/8	2.22	1.21	1.4	.5	.19
LFPP4VMC4	1/4	1/4	2.40	1.21	1.4	.5	.19
LFPP4VMC6	1/4	3/8	2.40	1.21	1.4	.5	.19
LFPP4VMC8	1/4	1/2	2.59	1.21	1.4	.5	.19
LFPP6VMC2	3/8	1/8	2.33	1.32	1.4	.5	.25
LFPP6VMC4	3/8	1/4	2.51	1.32	1.4	.5	.25
LFPP6VMC6	3/8	3/8	2.51	1.32	1.4	.5	.25
LFPP6VMC8	3/8	1/2	2.70	1.32	1.4	.5	.25

NOTE: PPL refers to Polypropylene. FCB refers to Fluorocarbon.

WARNING These products can expose you to chemicals including CARBON BLACK, or LEAD, which are known to the state of California to cause cancer, and LEAD which is known to cause birth defects or other reproductive harm. For more information go to www.P65Warnings.ca.gov.

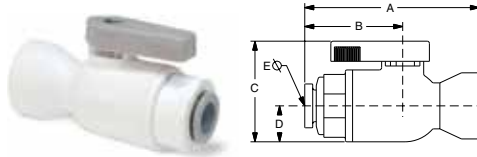

VFC - Valve Female Connector

PART NO.	NOM. TUBE O.D.	NPTF THREAD SIZE	A	B	C	D	ØE THRU HOLE MIN.
LFPP4VFC2	1/4	1/8	2.04	1.21	1.4	.5	.19
LFPP4VFC4	1/4	1/4	2.27	1.21	1.4	.5	.19
LFPP4VFC6	1/4	3/8	2.40	1.21	1.4	.5	.19
LFPP6VFC2	3/8	1/8	2.15	1.32	1.4	.5	.25
LFPP6VFC4	3/8	1/4	2.38	1.32	1.4	.5	.25
LFPP6VFC6	3/8	3/8	2.51	1.32	1.4	.5	.25

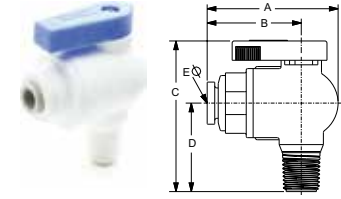

VME - Valve Male Elbow

PART NUMBER	NOM. TUBE O.D.	NPTF THREAD SIZE	A	B	C	D	ØE THRU HOLE MIN.
PP4VME2-MG (+)	1/4	1/8	1.74	1.21	2.00	1.10	.19
PP4VME4-MG	1/4	1/4	1.74	1.21	2.18	1.28	.19
PP4VME6-MG	1/4	3/8	1.74	1.21	2.18	1.28	.19
PP4VME8-MG (+)	1/4	1/2	1.74	1.21	2.37	1.47	.19
PP6VME2-MG (+)	3/8	1/8	1.85	1.32	2.00	1.10	.25
PP6VME4-MG	3/8	1/4	1.85	1.32	2.18	1.28	.25
PP6VME6-MG	3/8	3/8	1.85	1.32	2.18	1.28	.25
PP6VME8-MG	3/8	1/2	1.85	1.32	2.37	1.47	.25

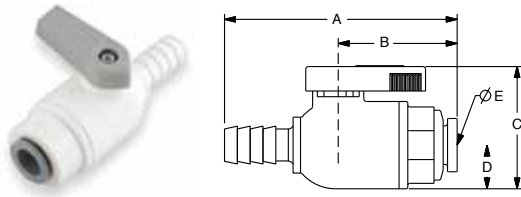

VUCPB - Valve Union Connector Barbed x Tube

PART NO.	HOSE ID	TUBE OD	OD	A	B	C	D	ØE THRU HOLE MIN.
LFPP4VUCPB4	1/4	1/4	.31	2.40	1.08	1.42	.50	.15
LFPP6VUCPB6	3/8	3/8	.43	2.63	1.32	1.42	.50	.19

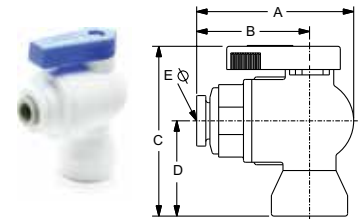

VFE - Valve Female Elbow

PART NUMBER	NOM. TUBE O.D.	NPTF THREAD SIZE	A	B	C	D	ØE THRU HOLE MIN.
PP4VFE2-MG (+)	1/4	1/8	1.74	1.21	1.82	.92	.19
PP4VFE4-MG	1/4	1/4	1.74	1.21	2.05	1.15	.19
PP4VFE6-MG	1/4	3/8	1.74	1.21	2.18	1.28	.19
PP6VFE2-MG (+)	3/8	1/8	1.85	1.32	1.82	.92	.25
PP6VFE4-MG	3/8	1/4	1.85	1.32	2.05	1.15	.25
PP6VFE6-MG	3/8	3/8	1.85	1.32	2.18	1.28	.25

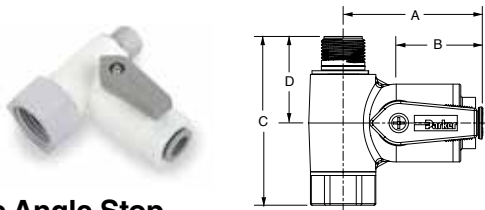

VAS - Valve Angle Stop

PART NO.	TUBE O.D.	MALE THD.	FEMALE THD.	A	B	C	D	E	F
LFPP4VAS6	1/4	3/8	3/8	1.95	1.24	2.17	1.11	1.41	.91
LFPP4VAS8	1/4	3/8	1/2	1.95	1.24	2.40	1.11	1.41	.91
LFPP6VAS6	3/8	3/8	3/8	2.06	1.35	2.17	1.11	1.41	.91
LFPP6VAS8	3/8	3/8	1/2	2.06	1.35	2.40	1.11	1.41	.91

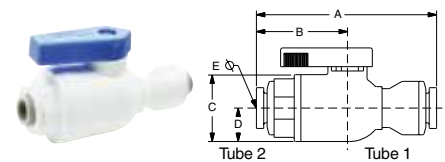

VUC - Valve Union Connector

PART NUMBER	1 TUBE SIZE	2 TUBE SIZE	A	B	C	D	ØE THRU HOLE MIN.
PP4VUC4-MG	1/4	1/4	2.55	1.22	1.0	.5	.19
PP4VUC6-MG	1/4	3/8	2.55	1.22	1.0	.5	.19
PP6VUC4-MG	3/8	1/4	2.57	1.30	1.0	.5	.19
PP6VUC6-MG	3/8	3/8	2.67	1.32	1.4	.5	.25

WARNING These products can expose you to chemicals including CARBON BLACK, or LEAD, which are known to the state of California to cause cancer, and LEAD which is known to cause birth defects or other reproductive harm. For more information go to www.P65Warnings.ca.gov.

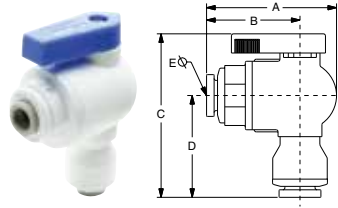

VEU - Valve Elbow Union

PART NUMBER	1 TUBE SIZE	2 TUBE SIZE	A	B	C	D	ØE THRU HOLE MIN.
PP4VEU4-MG	1/4	1/4	1.75	1.22	2.33	1.42	.19
PP4VEU6-MG	1/4	3/8	1.75	1.22	2.33	1.42	.11
PP6VEU4-MG	3/8	1/4	1.83	1.30	2.32	1.40	.19
PP6VEU6-MG	3/8	3/8	1.85	1.32	2.34	1.44	.25

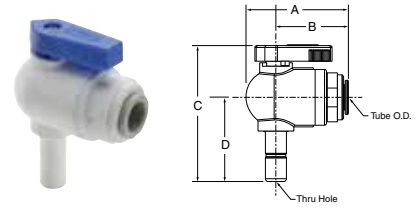

VTEU - Valve Tube Elbow Union

PART NUMBER	NOM. TUBE O.D.	STEM	A	B	C	D	ØE THRU HOLE MIN.
PP4VTEU6-MG	1/4	3/8	1.75	1.22	2.43	1.50	.17
PP6VTEU6-MG	3/8	3/8	1.83	1.30	2.43	1.50	.25

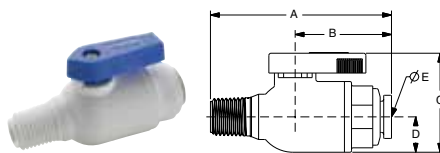

VMC - Valve Male Connector

PART NUMBER	NOM. TUBE O.D.	NPTF THREAD SIZE	A	B	C	D	ØE THRU HOLE MIN.
PP4VMC2-MG (+)	1/4	1/8	2.22	1.21	1.4	.5	.19
PP4VMC4-MG	1/4	1/4	2.40	1.21	1.4	.5	.19
PP4VMC6-MG	1/4	3/8	2.40	1.21	1.4	.5	.19
PP4VMC8-MG (+)	1/4	1/2	2.59	1.21	1.4	.5	.19
PP6VMC2-MG (+)	3/8	1/8	2.33	1.32	1.4	.5	.25
PP6VMC4-MG	3/8	1/4	2.51	1.32	1.4	.5	.25
PP6VMC6-MG	3/8	3/8	2.51	1.32	1.4	.5	.25
PP6VMC8-MG (+)	3/8	1/2	2.70	1.32	1.4	.5	.25

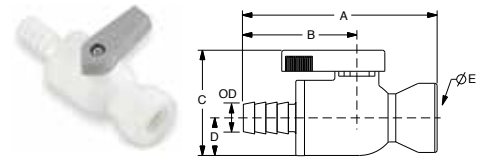

VFC - Valve Barbed Female Connector

PART NO.	HOSE I.D.	NPTF THD.	O.D.	A	B	C	D	ØE THRU HOLE MIN.
PBPP4VFC4	1/4	1/4	.31	2.76	1.60	1.41	.50	.15
PBPP6VFC6	3/8	3/8	.43	2.79	1.60	1.41	.50	.19

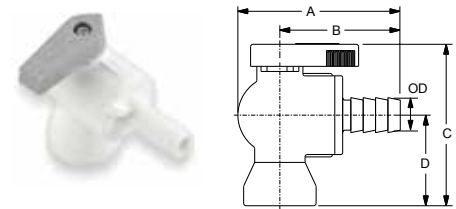

VFE - Valve Barbed Female Elbow

PART NO.	HOSE I.D.	NPTF THD.	O.D.	A	B	C	D	ØE THRU HOLE MIN.
PBPP4VFE4	1/4	1/4	.31	2.13	1.60	2.05	1.15	.15
PBPP6VFE4	3/8	1/4	.43	2.13	1.60	2.05	1.15	.15
PBPP6VFE6	3/8	3/8	.43	2.13	1.60	2.18	1.28	.19

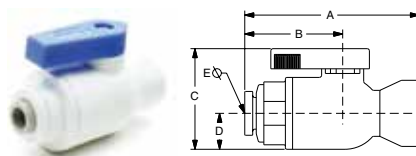

VFC - Valve Female Connector

PART NUMBER	NOM. TUBE O.D.	NPTF THREAD SIZE	A	B	C	D	ØE THRU HOLE MIN.
PP4VFC2-MG	1/4	1/8	2.04	1.21	1.4	.5	.19
PP4VFC4-MG	1/4	1/4	2.27	1.21	1.4	.5	.19
PP4VFC6-MG	1/4	3/8	2.40	1.21	1.4	.5	.19
PP6VFC2-MG	3/8	1/8	2.15	1.32	1.4	.5	.25
PP6VFC4-MG	3/8	1/4	2.38	1.32	1.4	.5	.25
PP6VFC6-MG	3/8	3/8	2.51	1.32	1.4	.5	.25

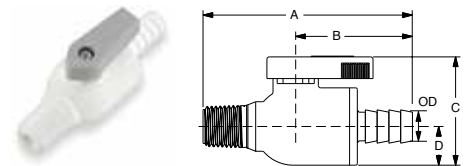

VMC - Valve Barbed Male Connector

PART NO.	HOSE I.D.	NPTF THD.	O.D.	A	B	C	D	ØE THRU HOLE MIN.
PBPP4VMC4	1/4	1/4	.31	2.79	1.60	1.42	.50	.15
PBPP6VMC6	3/8	3/8	.43	2.79	1.60	1.42	.50	.19

WARNING These products can expose you to chemicals including CARBON BLACK, or LEAD, which are known to the state of California to cause cancer, and LEAD which is known to cause birth defects or other reproductive harm. For more information go to www.P65Warnings.ca.gov.



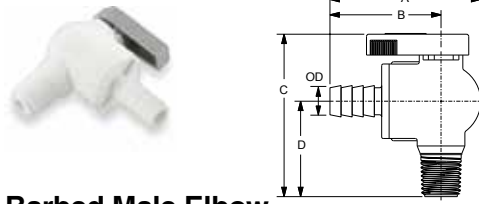

VME - Valve Barbed Male Elbow

PART NO.	HOSE I.D.	NPTF THD.	O.D.	A	B	C	D	ØE THRU HOLE MIN.
PBPP4VME4	1/4	1/4	.31	2.13	1.60	2.18	1.28	.15
PBPP6VME6	3/8	3/8	.43	2.13	1.60	2.18	1.28	.19

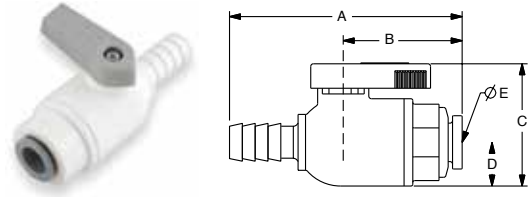

VUCPB - Valve Union Connector Barbed x Tube

PART NO.	HOSE ID	TUBE OD	OD	A	B	C	D	ØE THRU HOLE MIN.
LFPP4VUCPB4	1/4	1/4	.31	2.40	1.08	1.42	.50	.15
LFPP6VUCPB6	3/8	3/8	.43	2.63	1.32	1.42	.50	.19

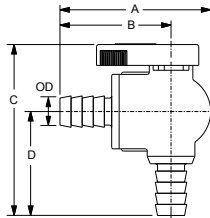

VEU - Parbarb Elbow Ball Valve

PART NO.	HOSE I.D.	O.D.	A	B	C	D	ØE THRU HOLE MIN.
PBPP4VEU4	1/4	.31	2.13	1.57	2.32	1.40	.15
PBPP6VEU6	3/8	.43	2.13	1.60	2.32	1.40	.25
PBPP8VEU8	1/2	.55	2.13	1.60	2.32	1.40	.25

BVC Ball Valve Clip

BV-Clip Shown below holding VUCPB and VME

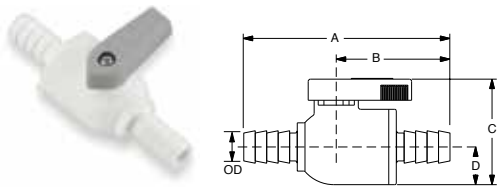
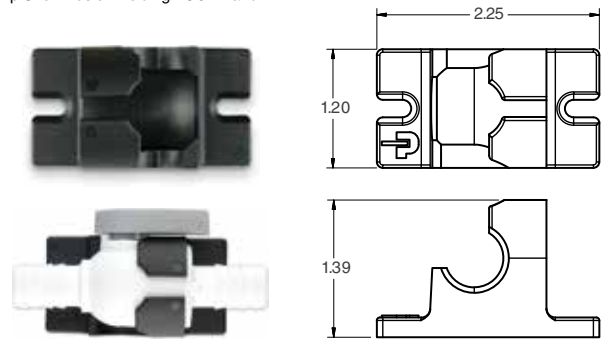

VUC - Valve Barbed Union Connector

PART NO.	HOSE I.D.	O.D.	A	B	C	D	ØE THRU HOLE MIN.
PBPP4VUC4	1/4	.31	2.91	1.60	1.42	.50	.15
PBPP6VUC6	3/8	.43	2.91	1.60	1.42	.50	.19
PBPP8VUC8	1/2	.55	2.91	1.60	1.42	.50	.25

WARNING These products can expose you to chemicals including CARBON BLACK, or LEAD, which are known to the state of California to cause cancer, and LEAD which is known to cause birth defects or other reproductive harm. For more information go to www.P65Warnings.ca.gov.





Plug Valves Series PV

Product Features:

- Extruded Brass Body
- One Piece Stem/Handle
- Acetal Stem/Handle
- 100% Leak Tested

Style:

- PV-Plug Valve

Type:

- 607-Male/Male
- 608-Male/Female
- 609-Female/Female

Specifications:

Pressure Range:

- Up to 250 PSI (17.2 bar)

Temperature Range

- -40° to +175° F (-40° to +79.4° C)

Assembly Instructions

To assure sealability and reliable performance, the valve must be installed so that the flow media travels in the direction of the arrow on the valve handle.



Valve Components

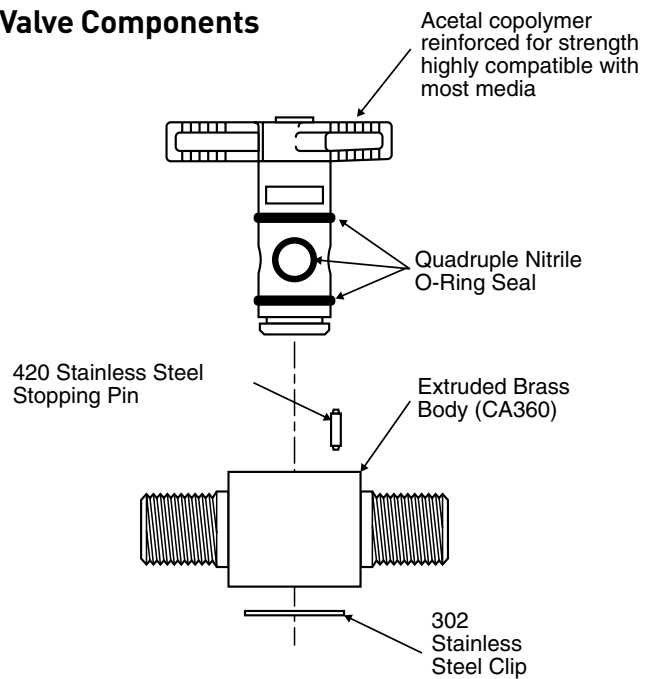

WARNING These products can expose you to chemicals including NICKEL or LEAD, which are known to the state of California to cause cancer, and LEAD which is known to cause birth defects or other reproductive harm. For more information go to www.P65Warnings.ca.gov.



Male Pipe to Male Pipe Plug Valve PV607

PART NO.	PIPE THREAD	H	L	M	N	N1	FLOW DIA. D
PV607-2	1/8	.67	1.34	1.66	1.38	.51	.200
PV607-4	1/4	.67	1.34	2.02	1.38	.51	.200

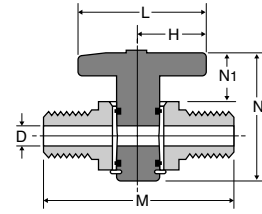

Female Pipe to Male Pipe Plug Valve PV608

PART NO.	PIPE THREAD	H	L	M	N	N1	FLOW DIA. D
PV608-2	1/8	.67	1.34	1.67	1.38	.51	.200
PV608-4	1/4	.67	1.34	2.06	1.38	.51	.200

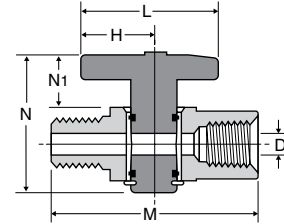

Female Pipe to Female Pipe Plug Valve PV609

PART NO.	PIPE THREAD	H	L	M	N	N1	FLOW DIA. D
PV609-2	1/8	.67	1.34	1.68	1.38	.51	.200
PV609-4	1/4	.67	1.34	2.10	1.38	.51	.200

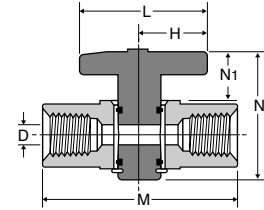

Mounting Bracket PVMB-001

PART NO.	H	M	N	N1	D
PVMB-001	.68	1.86	.90	.45	.135

Note: 1" diameter hole required in panel when using mounting bracket

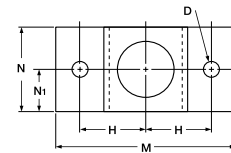

WARNING These products can expose you to chemicals including NICKEL or LEAD, which are known to the state of California to cause cancer, and LEAD which is known to cause birth defects or other reproductive harm. For more information go to www.P65Warnings.ca.gov.

Ball Valves

Rotary Actuator Series ACT



Product Features:

- One Piece Aluminum Extrusion Body
- PTFE Seals
- Stainless Steel Shaft
- Self Lubricated Vane Seal
- Anodized Aluminum Extrusion Vane

Specifications:

Pressure Range:

- 150 PSI (10.3 bar)
Maximum Air Pressure to Actuator
- Vacuum service 28 inches Hg

Temperature Range

- -40° to +180° F (-40° to +82.2° C)

How Do Vane Actuators Work?

Parker vane actuators provide the maximum amount of output torque from the smallest possible envelope size. They convert fluid power pressure into rotary motion for a wide variety of industrial applications. Double vane units produce twice the torque output of single vane actuators from identical envelope dimensions and have a maximum rotation of 95°.

A short cylindrical chamber encloses a vane attached to a central shaft. Fluid pressure differential is applied through a stationary barrier (stator) within the cylinder to one side of the vane. The opposite side of the vane is connected to exhaust through the stator. This pressure differential produces rotation of the vane and central shaft. Due to vane actuator design there will always be some internal bypass in these units.

Rotary Actuator Series ACT Features

(See figure 1, next page)

1. **Heads**-are precision machined from aluminum, then hard-coat anodized and PTFE impregnated to ensure long seal life and low breakaway pressure.
2. **Body** - is machined from a one-piece aluminum extrusion that incorporates the stator for superior rigidity. The extrusion is hard-coat anodized and PTFE impregnated, resulting in a smooth, slick seal surface which guarantees long seal life and low breakaway pressure.
3. **Shoulder Seal** - a nitrile-energized, PTFE seal is used to reduce bypass flow and friction, providing superior performance and long life.
4. **Shaft Seal** - the high-quality, self-lubricated, abrasion-resistant nitrile seal is a multiple lobe construction for leakfree operation and greater reliability.
5. **Shaft** - stainless steel provides high strength and corrosion resistance for the most demanding applications.
6. **Bearings** - hard-coat anodized aluminum-bearing surface with permanent solid film lubricant provides substantial shaft support and wear resistance, ensuring continuous lubrication, high performance, and long life.
7. **Mounting** - combination face and base mounting offer flexibility in application and design.
8. **Vane Seal** - a special self-lubricated, abrasion-resistant nitrile compound is molded into a one-piece vane seal, providing low breakaway pressure and long life, even with no lubrication. The vane seal is also removable so that field repairs can be made, if necessary.
9. **Vane** - a hard-coat anodized aluminum extrusion permanently affixed to shaft, forming a structurally sound assembly. The light weight also reduces inertia allowing faster operating speeds.



WARNING These products can expose you to chemicals including NICKEL or LEAD, which are known to the state of California to cause cancer, and LEAD which is known to cause birth defects or other reproductive harm. For more information go to www.P65Warnings.ca.gov.



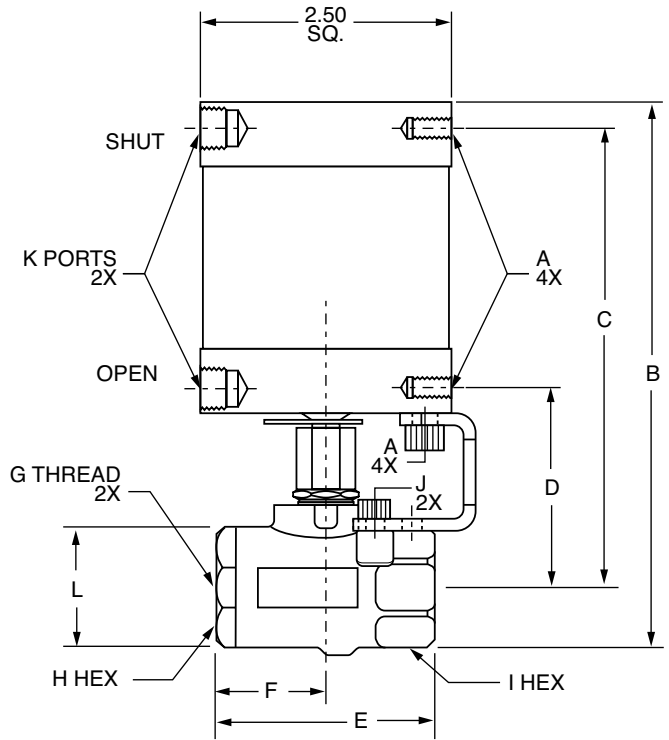
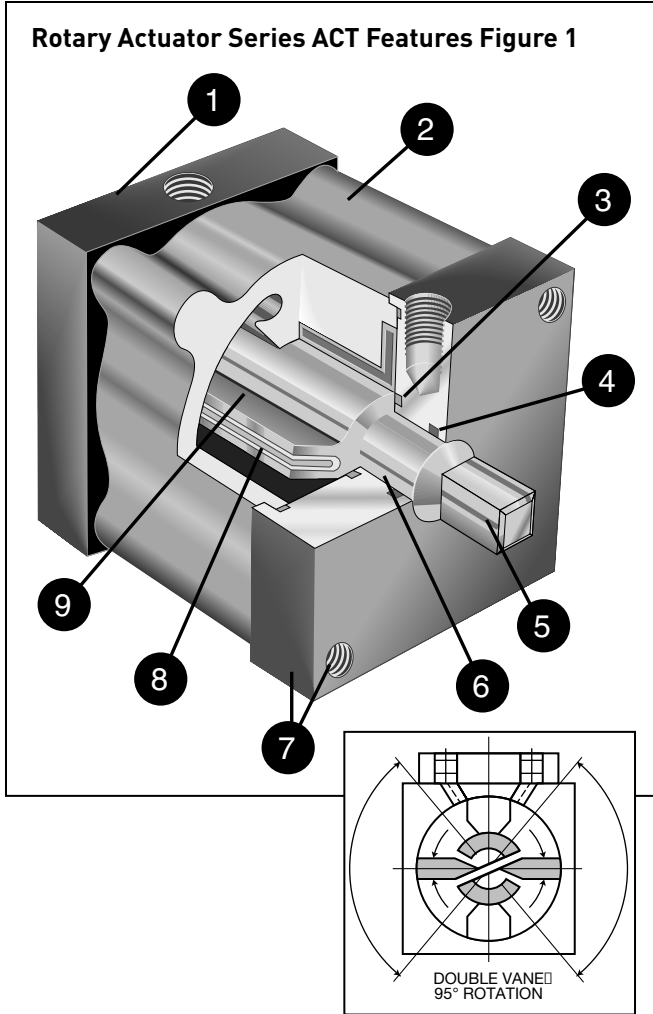

Rotary Actuator, Female Pipe Ends V502P-X-ACT

PART NO.	SIZE	A MTG. HOLES	B	C	D	E	F	G	H HEX	I HEX	J UNC	K NPTF	L	FLOW DIA.	FLOW CV	MIN. ACT PRESSURE (PSI)
V502P-4-ACT	1/4	1/4-20 UNC	5.25	4.47	1.91	2.03	1.00	1/4-18PTF	15/16	15/16	10-24	1/8-27	1.06	.375	4.0	50
V502P-6-ACT	3/8	1/4-20 UNC	5.25	4.47	1.91	2.03	1.00	3/8-18PTF	15/16	15/16	10-24	1/8-27	1.06	.375	5.8	50
V502P-8-ACT	1/2	1/4-20 UNC	5.38	4.54	1.98	2.20	1.09	1/2-14PTF*	1-1/16	1-1/16	10-24	1/8-27	1.19	.500	12.0	50
V502P-12-ACT	3/4	1/4-20 UNC	5.57	4.63	2.07	2.42	1.29	3/4-14PTF**	1-5/16	1-1/4	10-24	1/8-27	1.38	.685	25.0	75
V502P-16-ACT	1	1/4-20 UNC	5.85	4.76	2.20	2.75	1.38	1-11.5PTF**	1-9/16	1-1/2	10-24	1/8-27	1.67	.875	35.0	75

Stainless Steel Rotary Actuator, Female Pipe Ends V502SS-X-ACT

PART NO.	SIZE	A MTG. HOLES	B	C	D	E	F	G	H/I HEX	J	K NPTF	L	FLOW DIA.	FLOW CV
V502SS-4-ACT	1/4	1/4-20 UNC	5.41	4.61	2.05	2.07	1.04	1/4-18 NPT	15/16	10-24	1/8-27	1.10	.375	4.0
V502SS-6-ACT	3/8	1/4-20 UNC	5.41	4.61	2.05	2.07	1.04	3/8-18 NPT	15/16	10-24	1/8-27	1.10	.375	6.0
V502SS-8-ACT	1/2	1/4-20 UNC	5.53	4.64	2.08	2.27	1.17	1/2-14 NPT	1 1/16	10-24	1/8-27	1.28	.500	14.0

*Ptf Special Short. **Ptf Special Extra Short

WARNING These products can expose you to chemicals including NICKEL or LEAD, which are known to the state of California to cause cancer, and LEAD which is known to cause birth defects or other reproductive harm. For more information go to www.P65Warnings.ca.gov.

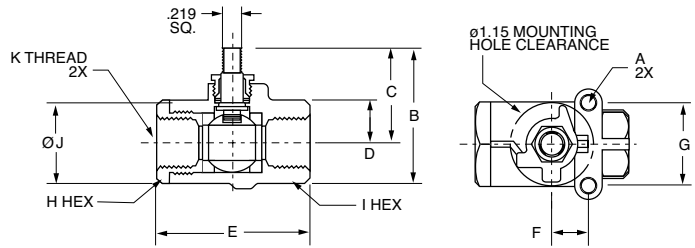

Actuator Sub-Assembly V502P-X-SUB

PART NO	SIZE	A UNC	B	C	D	E	F	G	H HEX	I HEX	J	K
V502P-4-SUB	1/4	10-24	1.68	1.15	.495	2.03	.50	1.12	15/16	15/16	1.06	1/4-18 PTF
V502P-6-SUB	3/8	10-24	1.68	1.15	.495	2.03	.50	1.12	15/16	15/16	1.06	3/8-18 PTF
V502P-8-SUB	1/2	10-24	1.78	1.19	.565	2.20	.50	1.12	1-1/16	1-1/16	1.19	1/2-14 PTF*
V502P-12-SUB	3/4	10-24	2.09	1.40	.655	2.42	.87	1.37	1-5/16	1-1/4	1.38	3/4-14 PTF**
V502P-16-SUB	1	10-24	2.38	1.54	.785	2.75	.87	1.37	1-9/16	1-1/2	1.67	1-11.5 PTF**

* PTF Special Short
 ** PTF Special Extra Short

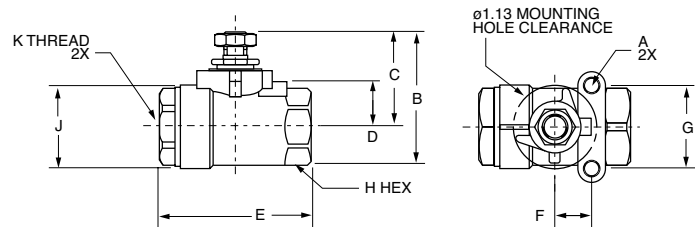

Actuator Sub-Assembly V502SS-X-SUB

PART NO	SIZE	A UNC	B	C	D	E	F	G	H HEX	J	K
V502SS-4-SUB	1/4	10-24	1.88	1.32	.63	2.07	.50	1.12	15/16	1.10	1/4-18 NPT
V502SS-6-SUB	3/8	10-24	1.88	1.32	.63	2.07	.50	1.12	15/16	1.10	3/8-18 NPT
V502SS-8-SUB	1/2	10-24	2.00	1.35	.66	2.27	.50	1.12	1-1/16	1.28	1/2-14 NPT

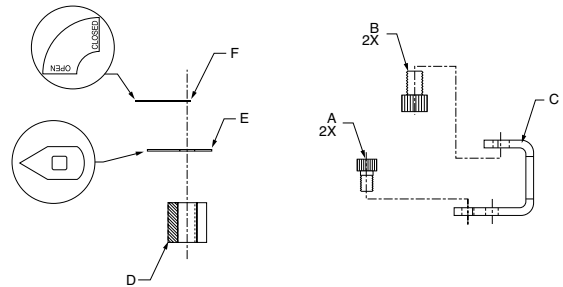

ACT-P-X-KIT

PART NO.	FOR USE WITH	A	B	C	D	E	F
ACT-P-1-KIT	V502P-4, 6, 8-ACT	10-24 UNC	1/4-20 UNC	BRACKET	.60 LONG COUPLING	POSITION INDICATOR	POSITION LABEL
ACT-P-2-KIT	V502P-12, 16-ACT	10-24 UNC	1/4-20 UNC	BRACKET	.55 LONG COUPLING	POSITION INDICATOR	POSITION LABEL

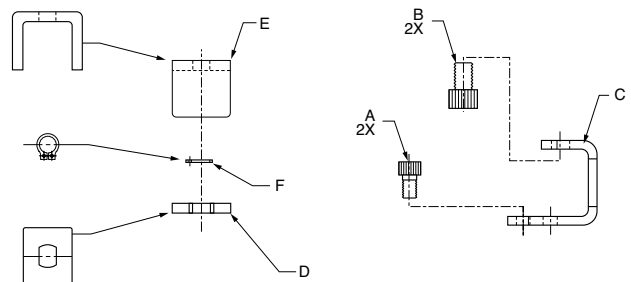

ACT-SS-X-KIT

PART NO.	FOR USE WITH	A	B	C	D	E	F
ACT-SS-1-KIT	V502SS-4, 6, 8-ACT	10-24 UNC	1/4-20 UNC	BRACKET	CLIP	HANDLE YOKE	SNAP RING

WARNING These products can expose you to chemicals including NICKEL or LEAD, which are known to the state of California to cause cancer, and LEAD which is known to cause birth defects or other reproductive harm. For more information go to www.P65Warnings.ca.gov.

Ball Valve Series BVGL



Product Features:

- Nickel plated brass body
- Chrome plated brass ball
- PTFE seats/seals
- Fluorocarbon stem seal

Specifications:

- Female threads manufactured in accordance to DIN 2999/ISO 228

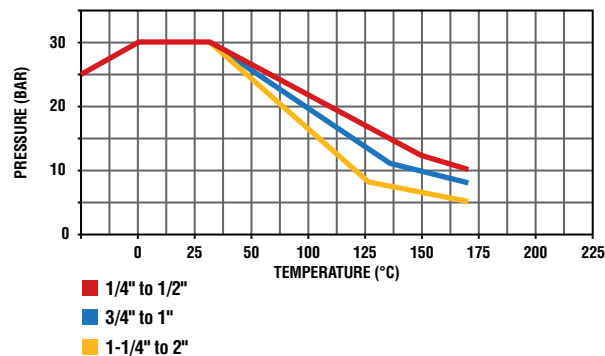

Advantages

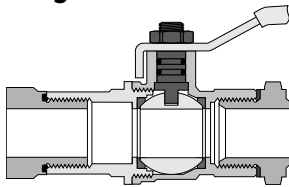

Long female threads

BVGL series valves are manufactured with long female threads in accordance to DIN 2999/ISO 228. This enables the valves to be used with Prestolok and brass adaptors but also Parker's range of steel hydraulic fittings, e.g. Triple-Lok, O-Lok, EO, and BSPP coned adaptors.

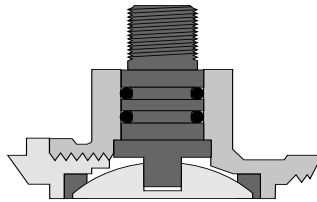

Anti extrusion stem

The BVGL series ball valves are fitted with an anti extrusion stem to prevent blow out in the case of pressure peaks. The stem is sealed with two Fluorocarbon O-rings for maximum safety and performance.

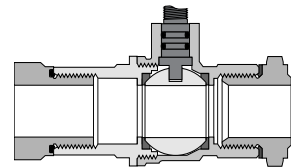

Full flow

All BVGL series valves are full-flow. This limits the turbulence created by the passage of fluid across the valve, minimizing pressure drop.



WARNING These products can expose you to chemicals including NICKEL or LEAD, which are known to the state of California to cause cancer, and LEAD which is known to cause birth defects or other reproductive harm. For more information go to www.P65Warnings.ca.gov.



BVGL BSPP Female/Female Valve with Lever Handle

PART NO.	DN MM	THREAD BSPP	C	H	L	L1	O
BVG4-1/4L	8	1/4	20	38	50	82	25.0
BVG4-3/8L	10	3/8	20	38	60	82	25.0
BVG4-1/2L	15	1/2	25	43	75	100	32.5
BVG4-3/4L	20	3/4	32	50	80	120	39.0
BVG4-1L	25	1	41	54	90	120	47.5
BVG4-1.1/4L	32	1 1/4	50	73	110	158	59.0
BVG4-1.1/2L	40	1 1/2	55	79	120	158	71.5
BVG4-2L	50	2	70	86	140	158	86.0

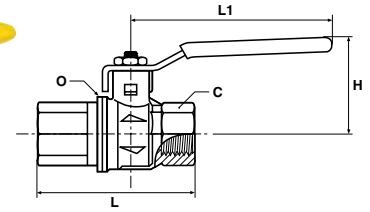

BVGT4 BSPP Female/Female Valve with Compact Handle

PART NO.	DN MM	THREAD BSPP	C	H	L	L1	O
BVGT4-1/4L	8	1/4	20	39	50	50	25.0
BVGT4-3/8L	10	3/8	20	39	60	50	25.0
BVGT4-1/2L	15	1/2	25	43	75	50	32.5
BVGT4-3/4L	20	3/4	32	47	80	60	39.0
BVGT4-1L	25	1	41	51	90	60	47.5

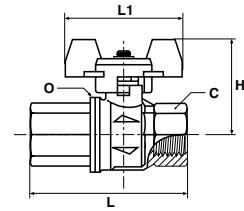

WARNING These products can expose you to chemicals including NICKEL or LEAD, which are known to the state of California to cause cancer, and LEAD which is known to cause birth defects or other reproductive harm. For more information go to www.P65Warnings.ca.gov.

Ball Valve Series BVGLOCK



Product Features:

- Nickel plated brass body
- Chrome plated brass ball
- PTFE seats /seals
- PTFE packing gland
- Carbon steel handle

Specifications:

- Meets the requirements of European directive DI 89/392/ CEE relating to the isolation of power supply and to meet the health and safety requirements for machines and materials in paragraphs L233-5 of the code DU Travail.

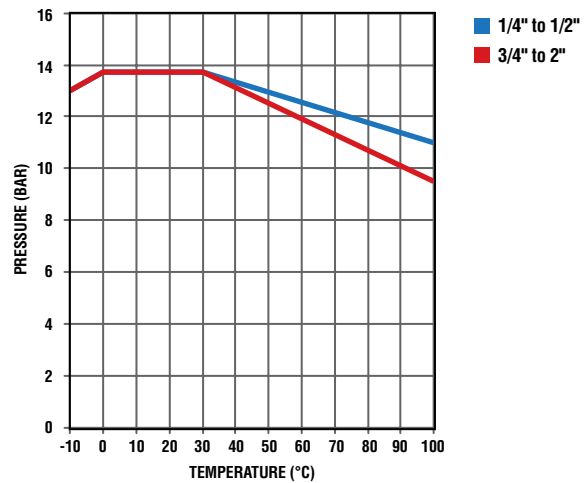

WARNING These products can expose you to chemicals including NICKEL or LEAD, which are known to the state of California to cause cancer, and LEAD which is known to cause birth defects or other reproductive harm. For more information go to www.P65Warnings.ca.gov.



Advantages

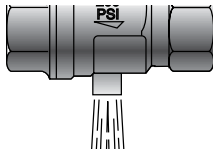

Threaded Exhaust

BVGLOCK series ball valves are manufactured with an exhaust port, this safety feature enables the downstream air pressure to be vented when the valve is closed. 1/4-1" have M5 thread. 1.1/4 and larger are not threaded.

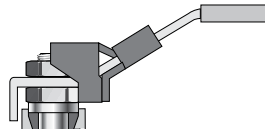

Lockable Handle

The BVGLOCK series ball valves are fitted with a handle that can be locked in the closed position with a padlock. This safety feature ensures the valve cannot be accidentally opened, and only authorized personnel can operate the valve.

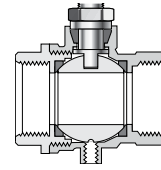

DIN 2999 / ISO 228 Female Threads

BVGLOCK series valves are manufactured with long female threads in accordance to DIN2999/ISO228. This enables the valves to be used with Prestolok and brass adaptors but also Parker's range of steel hydraulic fittings and EO-fittings form "A" or "C" to DIN 3852.

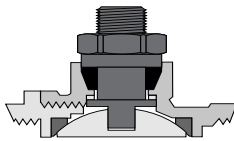

Anti Extrusion Stem

The BVGLOCK series ball valves are fitted with an anti-extrusion stem to prevent blow out in the case of pressure peaks.

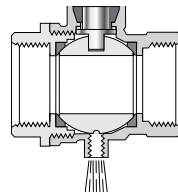

Full Flow

All BVGLOCK series valves are full-flow. This limits the turbulence created by the passage of fluid across the valve, minimizing pressure drop.

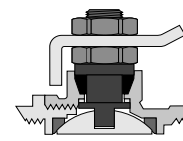

Adjustable Packing

The PTFE packing gland and adjustable washer are designed to give longer service life and lower operating torques.

BVG4PLOCK BSPP Female/Female, Vented, Locking Handle

PART NO.	D FLOW Ø	THREAD BSPP	C	G	H	I	L	L1	N
BVG4P-1/4 LOCK	8.0	1/4	20	22.5	47.5	12.0	45	96	M5
BVG4P-3/8 LOCK	9.5	3/8	20	22.5	47.5	12.0	45	96	
BVG4P-1/2 LOCK	15.0	1/2	25	29.5	52.0	15.5	59	96	
BVG4P-3/4 LOCK	19.0	3/4	31	32.0	59.5	17.0	64	117	
BVG4P-1 LOCK	24.0	1	40	40.5	63.5	21.0	81	117	
BVG4P-1.1/4LOCK	32.0	1-1/4	49	46.5	76.5	23.0	93	158	G1/4
BVG4P-1.1/2LOCK	40.0	1-1/2	54	51.0	82.5	23.0	102	158	
BVG4P-2LOCK	50.0	2	69	60.5	89.5	26.5	121	158	

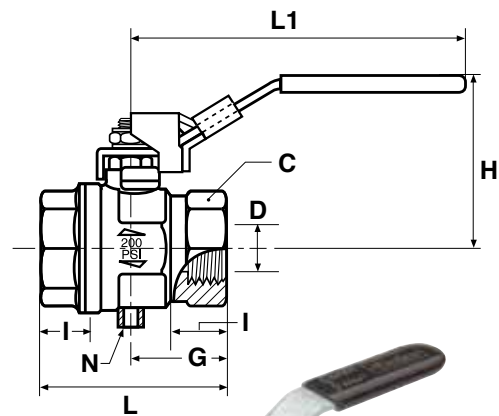

WARNING These products can expose you to chemicals including NICKEL or LEAD, which are known to the state of California to cause cancer, and LEAD which is known to cause birth defects or other reproductive harm. For more information go to www.P65Warnings.ca.gov.



Axial Valves



Parker's Axial Valve incorporates both the valve and actuation function. With pneumatic or electro-pneumatic control, it avoids many of the restrictions associated with traditional actuators.

Product Features:

- Compact, up to 50% smaller than valves with separate actuators
- Simple to install
- Common sub-base for solenoid control
- Automation of the open/close function
- Operation independent of the upstream and downstream pressure in the circuit

Specifications:

- Pressure Range:**
 - Up to 150 PSI (10.3 bar)
- Vacuum Service:**
 - 29 in Hg
- Pilot Pressure:**
 - NC: 60 to 115 PSI (4.1 to 7.9 bar)
- Temperature Range:**
 - -4° to +275° F (-20° to +135° C)

Water at ambient temperature under a 1 bar differential pressure.

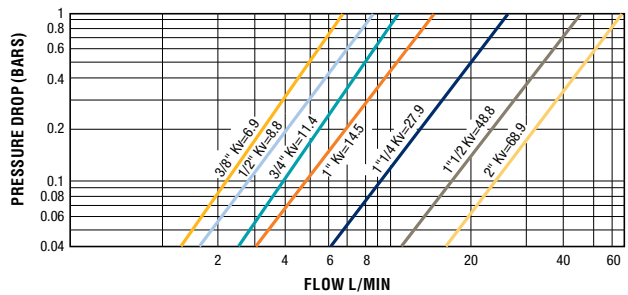

Applications:

- Injection Molding
- Pneumatics
- Packaging
- Textile
- Printing
- Robotics

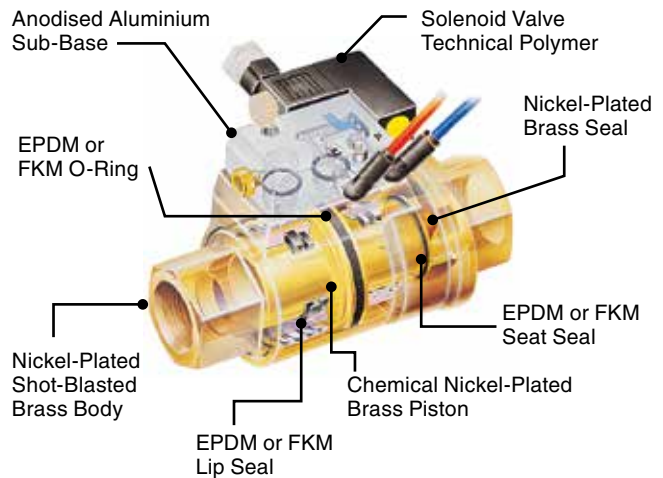

WARNING These products can expose you to chemicals including NICKEL or LEAD, which are known to the state of California to cause cancer, and LEAD which is known to cause birth defects or other reproductive harm. For more information go to www.P65Warnings.ca.gov.



Operation

Depending on operational requirement, air is passed into the actuation chamber to open or close the valve.

Normally Closed Axial Valve (NC)

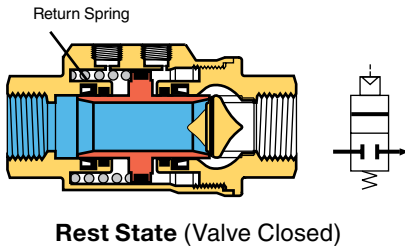

Normally Open Axial Valve (NO)

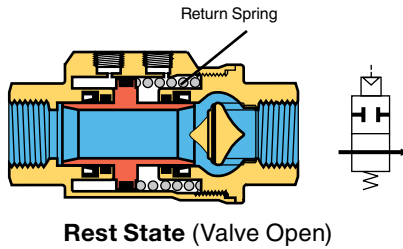

Double-Acting Axial Valve (DE)

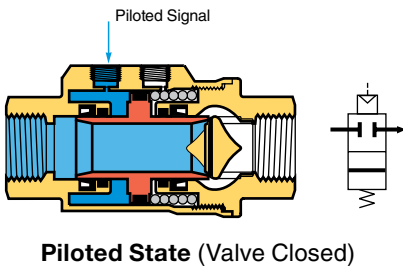
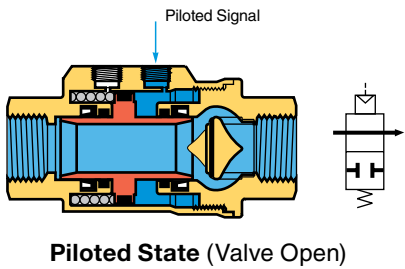
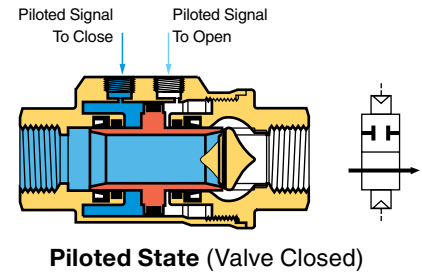

Installation Options

The Parker axial valve offers 3 different control methods dependant on the requirements of the installation:

Pneumatic Control

Example: Double-acting axial valve 4222

- Local compressed air control
- For repetitive on/off cycles
- Remote control where access to the machine is difficult
- For explosive or explosion prevention areas

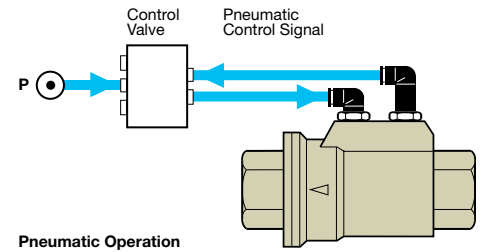

Electro-Pneumatic Control

Example: Normally closed axial valve 4202

- Sub-base and mini-solenoid valve 4298
- For automated industrial systems requiring remote control
- Namur seating plane solenoid valve

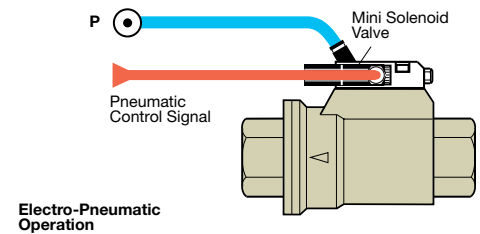

Dual Pneumatic and Electro-Pneumatic Control

Example: Normally open axial valve 4212

- Sub-base and mini-solenoid valve 4298
- Pneumatic push-button 4299
- Dual control structure
- For increased safety: prevents localised operating errors
- Namur seating plane solenoid valve

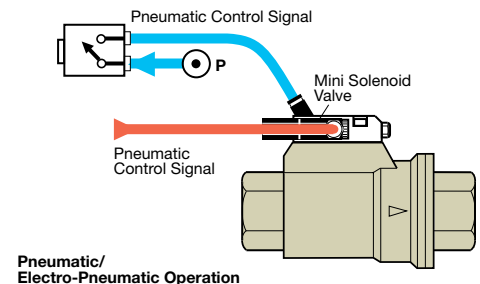

WARNING These products can expose you to chemicals including NICKEL or LEAD, which are known to the state of California to cause cancer, and LEAD which is known to cause birth defects or other reproductive harm. For more information go to www.P65Warnings.ca.gov.

4203 Normally Closed, Double Female – NPT

PART NO.	C NPT	DN	F MM	G IN	H IN	H1 IN	L IN	LB.
4203 10 18 20	3/8	10	22	1.81	2.12	1.21	3.60	1.79
4203 15 22 20	1/2	15	27	2.03	2.33	1.31	4.13	2.39
4203 20 28 20	3/4	20	33	2.50	2.76	1.51	4.92	3.60
4203 25 35 20	1	25	41	2.72	2.99	1.63	5.31	4.46
4203 32 43 20	1 1/4	32	50	3.39	3.59	1.90	6.02	7.28
4203 40 50 20	1 1/2	40	60	3.78	4.01	2.12	6.67	9.22
4203 50 44 20	2	50	75	4.29	4.50	2.35	7.39	14.02

Pilot port: 1/8 - 27 NPT Complete with 1/8 NPT silencer

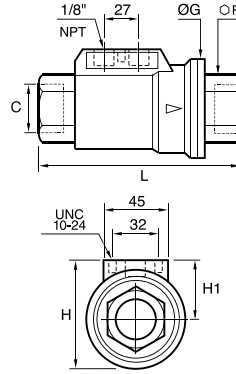

4202 Normally Closed, Double Female – BSPP

PART NO.	C BSPP	DN	F MM	G IN	H IN	H1 IN	L IN	KG.
4202 10 17 20	G3/8	10	22	46	54	31	98	.814
4202 15 21 20	G1/2	15	27	52	60	35	112	1.085
4202 20 27 20	G3/4	20	33	64	70	38	135	1.634
4202 25 34 20	G1	25	41	69	76	41.5	143	2.024
4202 32 42 20	G1 1/4	32	50	86	91	48	165	3.301
4202 40 49 20	G1 1/2	40	60	96	102	54	180	4.180
4202 50 48 20	G2	50	75	109	115	60.5	207	6.360

Pilot port: 1/8 BSPP Complete with 1/8 BSPT silencer

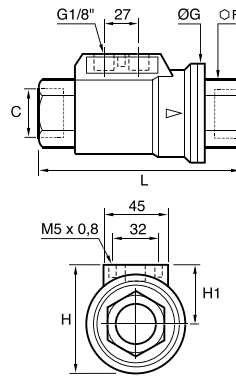

WARNING These products can expose you to chemicals including NICKEL or LEAD, which are known to the state of California to cause cancer, and LEAD which is known to cause birth defects or other reproductive harm. For more information go to www.P65Warnings.ca.gov.

Replacement Handles

	VALVE	PLATED STEEL LEVER W/COVER	S.S. LEVER (NO COVER)	S.S. LEVER W/COVER	TEE (NO COVER)	OVAL (W/COVER)	SHORT LEVER (NO COVER)	PLATED STEEL LKG. LEVER W/COVER	S.S. LOCKING LEVER W/COVER
V500P (501, 502, 506, 510, 590, 591)	-4	2560-10082	2566-00105		2566-00147	2566-00215	2566-00231	2560-10080	2560-10081
	-6	2560-10082	2566-00105		2566-00147	2566-00215	2566-00231	2560-10080	2560-10081
	-8	2560-10082	2566-00105		2566-00147	2566-00215	2566-00231	2560-10080	2560-10081
	-10	2560-10097	2566-00178		2566-00179			2566-10100	
	-12	2560-10097	2566-00178		2566-00179	2566-00180	—	2560-10100	2560-10101
	-16	2560-10097	2566-00178		2566-00179	2566-00180	—	2560-10100	2560-10101
	-20	2566-00143	2566-00153			—	2566-00142	2566-00135	—
	-24	2566-00143	2566-00153			—	2566-00142	2566-00135	—
V501SS & V502SS	-4	—		2566-00132	—	2566-00108	2566-00146	—	2566-00138
	-6	—		2566-00132	—	2566-00108	2566-00146	—	2566-00138
	-8	—		2566-00132	—	2566-00108	2566-00146	—	2566-00138
	-12	—		2566-00133	—	2566-00109	—	—	2566-00184
	-16	—		2566-00133	—	2566-00109	—	—	2566-00184
V502SS	-20	—		2566-00134	—	—	—	—	2566-00185
	-24	—		2566-00134	—	—	—	—	2566-00185
	-32	—		2566-00134	—	—	—	—	2566-00185
V500CS & V502CS	-4	2566-00158			2566-00170	2566-00166		2566-00162	
	-6	2566-00158			2566-00170	2566-00166		2566-00162	
	-8	2566-00158			2566-00171	2566-00166		2566-00162	
	-12	2566-00159			2566-00172	2566-00167		2566-00163	
	-16	2566-00159			2566-00172	2566-00167		2566-00163	
	-20	2566-00160				2566-00168		2566-00164	
	-24	2566-00160				2566-00168		2566-00164	
V506CS	-4	2566-00158			2566-00170	2566-00166		2566-00162	
	-6	2566-00158			2566-00170	2566-00166		2566-00162	
	-8							2566-00234	
	-12	—						2566-00235	
	-16	—						2566-00236	
V533P	-4	2560-10152	2566-00105		2566-00147	2566-00215	2566-00231	2560-10160	
	-6	2560-10152	2566-00105		2566-00147	2566-00215	2566-00231	2560-10160	
	-8	2560-10152	2566-00105		2566-00147	2566-00215	2566-00231	2560-10160	
	-12	2560-10153	2566-00178		2566-00179	2566-00180		2560-10168	
	-16	2560-10153	2566-00178		2566-00179	2566-00180		2560-10168	
V520P	-4				2566-00277			2566-00262	
	-6				2566-00277			2566-00262	
	-8				2566-00277			2566-00262	
	-12				2566-00280			2566-00261	
	-16				2566-00280			2566-00261	
	-20	2566-00143	2566-00153					2566-00135	
	-24	2566-00143	2566-00153					2566-00135	
	-32	2566-00143	2566-00153					2566-00135	
	40	2566-00253							
48	2566-00253								
V500HR, V506HP, V507HP	-4							BVHPLK-1 ^A	
	-6							BVHPLK-1 ^A	
	-8							BVHPLK-1 ^A	
	-12							BVHPLK-2 ^A	
	-16							BVHPLK-2 ^A	
	-20							BVHPLK-3 ^A	
	-24							BVHPLK-3 ^A	
-32							BVHPLK-3 ^A		

^A Locking kit for use with standard handles

Replacement Handle Nuts

VALVE	PLATED STEEL	STAINLESS STEEL
V500P-4	2567-00020	2567-00023
V500P-6	2567-00020	2567-00023
V500P-8	2567-00020	2567-00023
V500P-12	2567-00055	2567-00057
V500P-16	2567-00055	2567-00057
V500P-20	2567-00051	2567-00052
V500P-24	2567-00051	2567-00052
V500P-32	2567-00051	2567-00052
V500CS-4	2567-00020	2567-00023
V500CS-6	2567-00020	2567-00023
V500CS-8	2564-00020	2567-00023

Replacement Handle Covers

VALVE	LEVER	SHORT LEVER	TEE
V500P-4	2569-00108	2569-00342	2569-00155
V500P-6	2569-00108	2569-00342	2569-00155
V500P-8	2569-00108	2569-00342	2569-00155
V500P-12	2569-00296		2569-00155
V500P-16	2569-00296		2569-00155
V500P-20	2569-00229	2569-00234	
V500P-24	2569-00229	2569-00234	
V500P-32	2569-00229	2569-00234	
V502SS-4		2569-00203	
V502SS-6		2569-00203	
V502SS-8		2569-00203	

STX	Stem Extension Kit
P	For use on Brass Ball Valves
1	1: 1/4" thru 1/2" valves 2: 3/4" thru 1" valves
125	125: 1-1/4" extension length 225: 2-1/4" extension length

STX	Stem Extension Kit
SS	For use on Stainless Steel Ball Valves
1	1: 1/4" thru 1/2" valves 2: 3/4" thru 1" valves 3: 1-1/4"-2" valves
125	125: 1-1/4" extension length 225: 2-1/4" extension length

All stem extension kit componentry is made from high quality, corrosion resistant stainless steel

Note: Stem extensions cannot be used with series 509 and series 520.

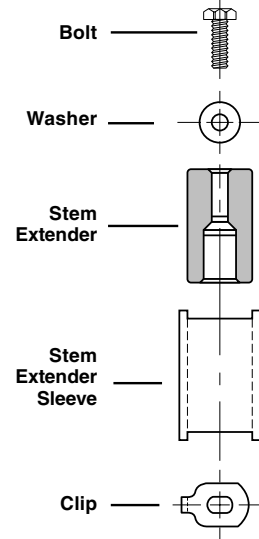

Brass Valve Extension Dimensions STX-P-1-125

PART NO.	VALVE SIZE	B HEX	C HEX	H	L	M	N	D FLOW Ø
STX-P-1-125	1/4	15/16	15/16	3.96	4.96	2.03	3.73	.375
STX-P-1-125	3/8	15/16	15/16	3.96	4.96	2.03	3.73	.375
STX-P-1-125	1/2	1-1/16	1-1/16	3.96	5.05	2.20	3.84	.500
STX-P-2-125	3/4	1-1/4	1-5/16	3.96	5.25	2.42	4.06	.685
STX-P-2-125	1	1-1/2	1-9/16	3.96	5.89	2.75	4.33	.875

Note: Drawing shows STX-P assembled to XV500P series-not included

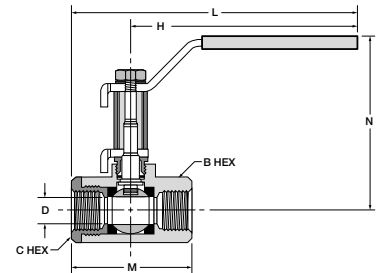

Brass Valve Extension Dimensions STX-P-1-225

PART NO.	VALVE SIZE	B HEX	C HEX	H	L	M	N	D FLOW Ø
STX-P-1-225	1/4	15/16	15/16	3.96	4.96	2.03	4.73	.375
STX-P-1-225	3/8	15/16	15/16	3.96	4.96	2.03	4.73	.375
STX-P-1-225	1/2	1-1/16	1-1/16	3.96	5.05	2.20	4.84	.500
STX-P-2-225	3/4	1-1/4	1-5/16	3.96	5.25	2.42	5.06	.685
STX-P-2-225	1	1-1/2	1-9/16	3.96	5.89	2.75	5.33	.875

Note: Drawing shows STX-P assembled to XV500P series-not included

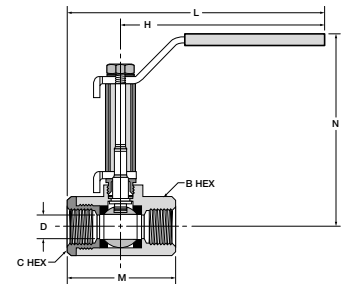

WARNING These products can expose you to chemicals including NICKEL or LEAD, which are known to the state of California to cause cancer, and LEAD which is known to cause birth defects or other reproductive harm. For more information go to www.P65Warnings.ca.gov.

Needle Valves



Parker's all brass needle valves have metal-to-metal seats with fine thread screwdown. The specially formulated low temperature seal remains elastic to temperatures as low as -40°F (-40°C).

Product Features:

- Extruded Brass Body & Stem
- Low Temperature Seal
- Metal-to-Metal Seal
- Pin Handle

Specifications:

Pressure Range:

- Up to 150 PSI (10.3 bar)

Temperature Range

- -40° to $+175^{\circ}\text{F}$ (-20° to $+79.4^{\circ}\text{C}$)
- Humidifier Valve Kit & Self Piercing Humidifier Kit:
 -30° to $+250^{\circ}\text{F}$ (-34.4° to $+121.1^{\circ}\text{C}$)
- NV311P/NV312P: 0° to $+150^{\circ}\text{F}$ (-17.7° to $+65.5^{\circ}\text{C}$)

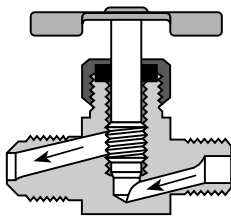
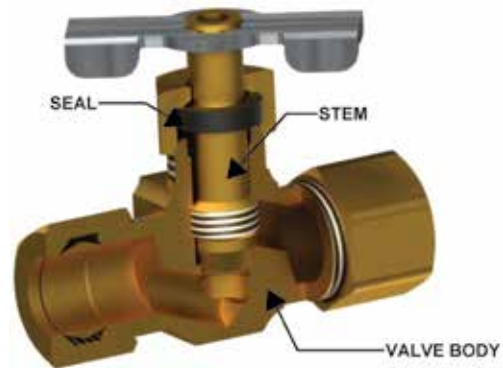

Needle Valves Installation Instructions

Series NV valves should always be installed with the pressure against the seat. Refer to drawing to determine correct direction of flow.

WARNING These products can expose you to chemicals including NICKEL or LEAD, which are known to the state of California to cause cancer, and LEAD which is known to cause birth defects or other reproductive harm. For more information go to www.P65Warnings.ca.gov.



Angle Needle Valve NV101F

Flare to Male Pipe * Provided with Pin Handle
 Temperature Range: -45° to +250° F (-42.7° to +121.1° C)

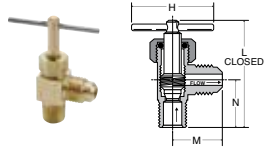

PART NO.	TUBE SIZE	PIPE THREAD	H	L	M	N
NV101F-4-2*	1/4	1/8	1.50	1.58	.75	.66
NV101F-6-4	3/8	1/4	1.38	1.86	.95	.90

Needle Valve NV102F

Flare to Flare *Provided with Pin Handle
 Temperature Range: -45° to +250° F (-42.7° to +121.1° C)

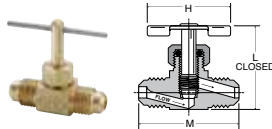

PART NO.	TUBE SIZE	H	L	M
NV102F-4*	1/4	1.50	1.34	1.50

Needle Valve NV103F

Flare to Male Pipe *Provided with Pin Handle
 Temperature Range: -45° to +250° F (-42.7° to +121.1° C)

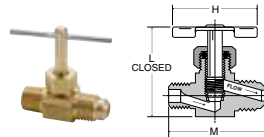

PART NO.	TUBE SIZE	PIPE THREAD	H	L	M
NV103F-4-2*	1/4	1/8	1.50	1.33	1.35

Humidifier Valve HV104C

Temperature Range: -45° to +250° F (-42.7° to +121.1° C)

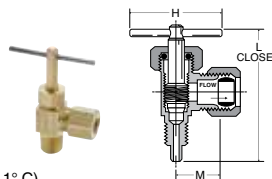

PART NO.	TUBE SIZE	PIPE THREAD	H	L	M
HV104C-4-2	1/4	1/8	1.50	1.89	.53

Humidifier Valve clamp kit HV104C-kit

Temperature Range: -30° to +250° F (-34.4° to +121.1° C) Clamp fits 3/8" O.D. through 1.315" O.D. tube or pipe. Kit includes 60PT-4 and 63PT-4 for assembly with plastic or nylon tubing. For complete kit, specify entire part number as shown below:

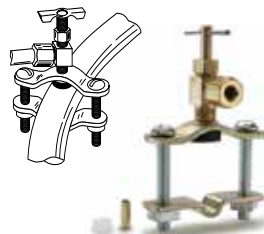

PART NO.	TUBE SIZE	PIPE THREAD
HV104C-4-2 KIT	1/4	1/8

Self-Piercing Humidifier Valve clamp kit SPV104C-kit

Temperature Range: -30° to +250° F (-34.4° to +121.1° C) Clamp fits 3/8" O.D. through 1.315" O.D. tube or pipe. Kit includes 60PT-4 and 63PT-4 for assembly with plastic or nylon tubing. For complete kit, specify entire part number as shown below:

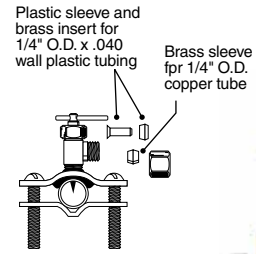

PART NO.	TUBE SIZE	PIPE THREAD
SPV104C KIT	1/4	1/8

Angle Needle Valve NV104C-NV104CA

Compression to Male Pipe *Provided with Pin Handle
 Temperature Range: -45° to +250° F (-42.7° to +121.1° C)

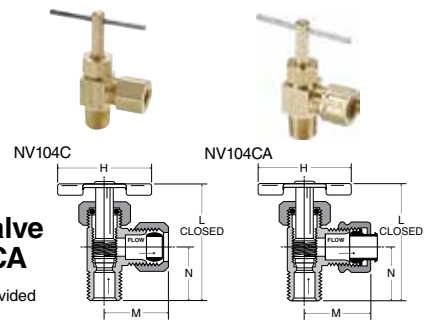

PART NO.	TUBE SIZE	PIPE THREAD	H	L	M	N
NV104C-4-2*	1/4	1/8	1.50	1.54	.88	.67
NV104CA-4-2*	1/4	1/8	1.50	1.49	.77	.66
NV104C-4-4	1/4	1/4	1.38	1.80	.93	.75
NV104C-5-2*	5/16	1/8	1.50	1.63	.88	.68
NV104C-6-4	3/8	1/4	1.38	1.76	.94	.81

Needle Valve NV105C-NV105CA

Compression to Compression
 *Provided with Pin Handle
 Temperature Range: -45° to +250° F (-42.7° to +121.1° C)

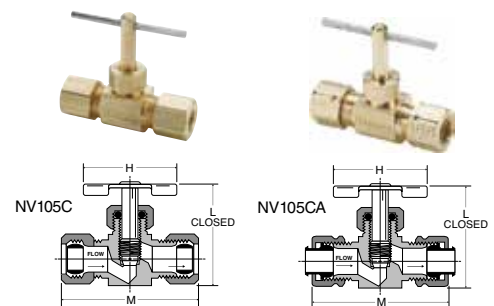

PART NO.	TUBE SIZE	H	L	M
NV105C-4*	1/4	1.50	1.41	1.75
NV105C-5*	5/16	1.50	1.35	1.73
NV105C-6	3/8	1.38	1.55	1.93
NV105CA-4*	1/4	1.50	1.41	1.64
NV105CA-6	3/8	1.38	1.55	1.78

WARNING These products can expose you to chemicals including NICKEL or LEAD, which are known to the state of California to cause cancer, and LEAD which is known to cause birth defects or other reproductive harm. For more information go to www.P65Warnings.ca.gov.

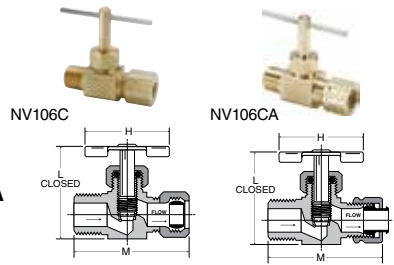

Needle Valve NV106C-NV106CA

Compression to Male Pipe
 *Provided with Pin Handle
 Temperature Range: -45° to +250° F (-42.7° to +121.1° C)

PART NO.	TUBE SIZE	PIPE THREAD	H	L	M
NV106C-4-2*	1/4	1/8	1.50	1.41	1.53
NV106C-4-4*	1/4	1/4	1.50	1.40	1.55
NV106C-5-2*	5/16	1/8	1.50	1.35	1.50
NV106C-6-4	3/8	1/4	1.38	1.56	1.75
NV106CA-4-2	1/4	1/8	1.50	1.41	1.47
NV106CA-4-4*	1/4	1/4	1.50	1.33	1.52
NV106CA-6-4	3/8	1/4	1.38	1.53	1.78

Needle Valve NV311P

Poly-Tite to Male Pipe
 Temperature Range: 0° to +150° F (0° to +65.5° C)

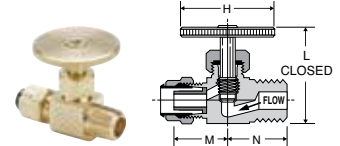

PART NO.	TUBE SIZE	PIPE THREAD	H	L	M	N
NV311P-4-2	1/4	1/8	1.07	1.17	.50	.63
NV311P-4-4	1/4	1/4	1.07	1.18	.50	.72
NV311P-6-4	3/8	1/4	1.07	1.19	.56	.72

Needle Valve NV107P

Male Pipe to Male Pipe
 *Provided with Pin Handle
 Temperature Range: -45° to +250° F (-42.7° to +121.1° C)

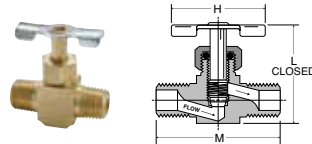

PART NO.	PIPE THREAD	H	L	M
NV107P-2*	1/8	1.50	1.35	1.25
NV107P-4	1/4	1.38	1.54	1.65

Needle Valve NV108P

Female Pipe to Male Pipe
 *Provided with Pin Handle
 Temperature Range: -45° to +250° F (-42.7° to +121.1° C)

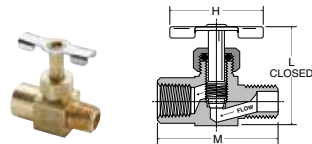

PART NO.	PIPE THREAD	H	L	M
NV108P-2*	1/8	1.50	1.36	1.24
NV108P-4	1/4	1.38	1.56	1.61

Needle Valve NV109P

Female Pipe to Female Pipe
 *Provided with Pin Handle
 Temperature Range: -45° to +250° F (-42.7° to +121.1° C)

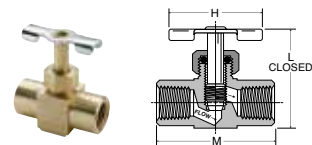

PART NO.	PIPE THREAD	H	L	M
NV109P-2*	1/8	1.50	1.35	1.25
NV109P-4	1/4	1.38	1.53	1.60

Angle Needle Valve NV312P

Poly-Tite to Male Pipe
 Temperature Range: 0° to +150° F (0° to +65.5° C)

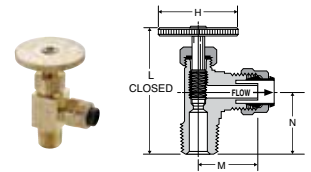

PART NO.	TUBE SIZE	PIPE THREAD	H	L	M	N
NV312P-4-2	1/4	1/8	1.07	1.53	.48	.68
NV312P-4-4	1/4	1/4	1.07	1.72	.56	.86
NV312P-6-4	3/8	1/4	1.07	1.68	.64	.86

WARNING These products can expose you to chemicals including NICKEL or LEAD, which are known to the state of California to cause cancer, and LEAD which is known to cause birth defects or other reproductive harm. For more information go to www.P65Warnings.ca.gov.

Drain Cocks/ Ground Plug Shutoff



Parker's ground plug shutoffs are manufactured from castings or forged bodies for extra strength. Hand tightening provides a metal-to-metal seal. Drain cocks are manufactured in both external and internal seats.

Specifications:

Pressure Range:

- Ground Plug Shutoff: 30 PSI (2.0 bar)
- Drain Cocks: Up to 150 PSI (10.3 bar)

Temperature Range

- Ground Plug Shutoff: 32° to +125° F (0° to +51.6° C)
- V406P/V407P: -40° to +180° F (-40° to +82.2° C)
- Drain Cocks: -65° to +250° F (-53.8° to +121.1° C)
- DCR601: -30° to +250° F (-34.4° to +121.1° C)



WARNING These products can expose you to chemicals including NICKEL or LEAD, which are known to the state of California to cause cancer, and LEAD which is known to cause birth defects or other reproductive harm. For more information go to www.P65Warnings.ca.gov.



Ground Plug Shutoff V203F

Flare to Flare
Temperature Range: +32° to +125° F (0° to +51.6° C)

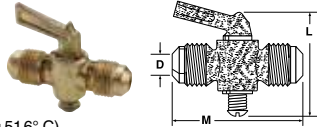

PART NO.	TUBE SIZE	L	M	FLOW DIA. D
V203F-6-6	3/8	2.26	2.13	.220
V203F-8-8	1/2	2.26	2.50	.281

Ground Plug Shutoff V204F

Flare to Male Pipe
Temperature Range: +32° to +125° F (0° to +51.6° C)

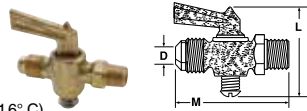

PART NO.	TUBE SIZE	PIPE THREAD	L	M	FLOW DIA. D
V204F-4-2	1/4	1/8	1.85	2.00	.188
V204F-6-4	3/8	1/4	1.85	2.18	.218

Ground Plug Shutoff V303C / V303CA

Compression to Compression
Temperature Range: +32° to +125° F (0° to +51.6° C)

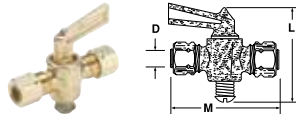

PART NO.	TUBE SIZE	L	M	FLOW DIA. D
V303C-4-4	1/4	1.88	2.33	.188
V303CA-4-4	1/4	1.90	1.75	.188
V303C-6-6	3/8	2.26	2.45	.218
V303CA-6-6	3/8	1.76	1.60	.218

Ground Plug Shutoff V304C / V304CA

Compression to Male Pipe
Temperature Range: +32° to +125° F (0° to +51.6° C)

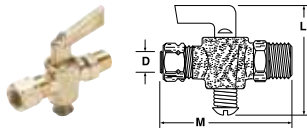

PART NO.	TUBE SIZE	PIPE THREAD	L	M	FLOW DIA. D
V304C-4-2	1/4	1/8	1.90	2.29	.188
V304CA-4-2	1/4	1/8	1.88	2.00	.188
V304C-4-4	1/4	1/4	1.90	2.15	.188
V304C-6-4	3/8	1/4	1.83	2.24	.218
V304CA-6-4	3/8	1/4	1.83	2.11	.218

Ground Plug Shutoff V401P

Male Pipe to Male Pipe
Temperature Range: +32° to +125° F (0° to +51.6° C)

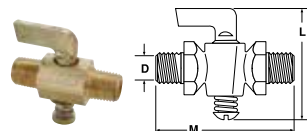

PART NO.	PIPE THREAD	L	M	FLOW DIA. D
V401P-2-2	1/8	1.90	2.25	.188
V401P-4-4	1/4	1.90	1.98	.188

Ground Plug Shutoff V402P

Female Pipe to Male Pipe
Temperature Range: +32° to +125° F (0° to +51.6° C)

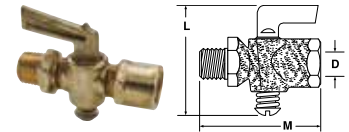

PART NO.	FEMALE PIPE THREAD	PIPE THREAD	L	M	FLOW DIA. D
V402P-2-2	1/8	1/8	1.85	1.78	.218
V402P-4-4	1/4	1/4	1.86	2.26	.218
V402P-6-6	3/8	3/8	2.34	2.21	.245

Ground Plug Shutoff V403P

Female Pipe to Female Pipe
Temperature Range: +32° to +125° F (0° to +51.6° C)

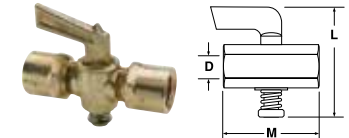

PART NO.	FEMALE PIPE THREAD	L	M	FLOW DIA. D
V403P-2-2	1/8	1.90	1.51	.218
V403P-4-4	1/4	1.90	1.65	.188
V403P-6-6*	3/8	2.25	2.00	.250

*Made from extruded bar stock

Three-way valve V406P

Female Pipe three ends
Temperature Range: -40° to +180° F (-40° to +82.2° C)

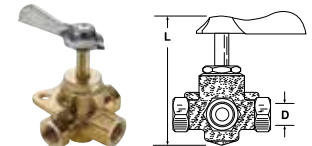

PART NO.	PIPE THREAD	L	FLOW DIA. D
V406P-4	1/4	3.10	.281

Four-way valve V407P

Female Pipe four ends
Temperature Range: -40° to +180° F (-40° to +82.2° C)

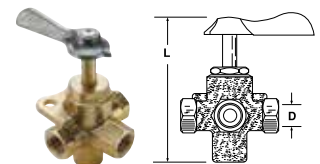

PART NO.	PIPE THREAD	L	FLOW DIA. D
V407P-4	1/4	3.30	.281

Ground Plug Shutoff DC601

Temperature Range: +32° to +125° F (0° to +51.6° C)

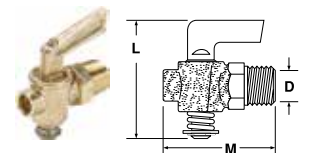

PART NO.	PIPE THREAD	L	M	FLOW DIA. D
DC601-2	1/8	1.90	1.40	.170
DC601-4	1/4	1.90	1.52	.170
DC601-6	3/8	2.26	1.74	.281
DC601-8	1/2	2.29	1.82	.281

WARNING These products can expose you to chemicals including NICKEL or LEAD, which are known to the state of California to cause cancer, and LEAD which is known to cause birth defects or other reproductive harm. For more information go to www.P65Warnings.ca.gov.

Drain Cock DCR601

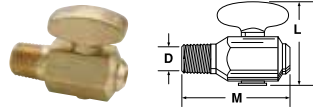

Temperature Range: -30° to +250° F (-34.4° to +121.1° C)

PART NO.	PIPE THREAD	L	M	FLOW DIA. D
DCR601-4	1/4	1.41	1.73	.156

Bib Drain Valve DC607

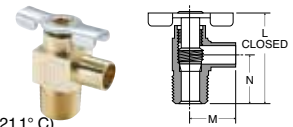

Temperature Range: -65° to +250° F (-53.8° to +121.1° C)

PART NO.	HOSE SIZE	PIPE THREAD	FLOW	L	M	N
DC607-4	3/8	1/4	.31	1.32	.67	.71

Internal Seal Drain Cock DC602

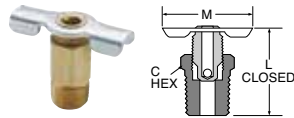

Temperature Range: -65° to +250° F (-53.8° to +121.1° C)

PART NO.	PIPE THREAD	C HEX	L	M
DC602-2	1/8	13/32	.92	1.25
DC602-4	1/4	9/16	.94	1.25

Drain Cock DC603

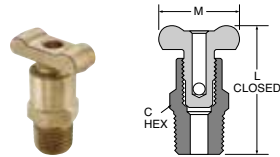

Temperature Range: -65° to +250° F (-53.8° to +121.1° C)

PART NO.	PIPE THREAD	C HEX	L	M
DC603-2	1/8	5/8	1.41	1.00
DC603-4	1/4	5/8	1.54	1.16
DC603-6	3/8	11/16	1.63	1.16

External Seal Drain Cock DC604

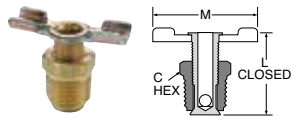

Temperature Range: -65° to +250° F (-53.8° to +121.1° C)

PART NO.	PIPE THREAD	C HEX	L	M
DC604-2*	1/8	7/16	.85	1.25
DC604-4	1/4	9/16	1.00	1.38
DC604-6*	3/8	11/16	1.22	1.68

*When assembled handle wings are down facing

External Seal Drain Cock DC606

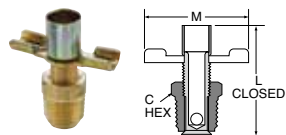

Temperature Range: -65° to +250° F (-53.8° to +121.1° C)

PART NO.	PIPE THREAD	C HEX	L	M
DC606-4	1/4-18	9/16	1.50	1.38

WARNING These products can expose you to chemicals including NICKEL or LEAD, which are known to the state of California to cause cancer, and LEAD which is known to cause birth defects or other reproductive harm. For more information go to www.P65Warnings.ca.gov.



Accessories

Blow Guns

Silencers

Bins, Bags &
Copper Tubing



For Bins information visit:
www.parker.com/bins



Blow Guns	410-S Controlled Pressure	410-SV Controlled Pressure	415-S Controlled Pressure	400-S-TIP Replacement Tip	410 Full Pressure	410-N Full Pressure
	 p. L5	 p. L5	 p. L5	 p. L5	 p. L5	 p. L5
415-N Full Pressure	BG441-NBL BG Series	BG442-SBL BG Series	BG443-NBL BG Series	BG444-SBL BG Series	0653 NPT/BSPP	0652-0655 BSPP
 p. L5	 p. L6	 p. L6	 p. L6	 p. L6	 p. L7	 p. L7
0656-0657 Angled Nozzle	Nozzles	0690 03 Straight Tube Nozzle Long	0690 04 Straight Tube Nozzle Short	0690 05 Angled Tube Nozzle Long	0690 06 Angled Tube Nozzle Short	0690 08 Coanda Effect Nozzle
 p. L7		 p. L8	 p. L8	 p. L8	 p. L8	 p. L9
0690 09 Air Screen Nozzle	0690 10 Booster Nozzle	0690 11 Booster Nozzle with Air Screen	Silencers	0673 0610 0670 Threaded Silencer UNF, NPT or BSPP	0673 Compact Threaded Silencer Male BSPP, M5	0677 Miniature Silencer BSPP
 p. L9	 p. L9	 p. L9		 p. L10	 p. L10	 p. L10
0671 Plug-In Silencer	0614 0672 Flow Control Silencer Male NPT, BSPP	0611 0674 Threaded Silencer NPT, BSPP, M5	0676 Flow Control Silencer BSPP	0682 Stainless Steel Threaded Silencer Male BSPP	0683 Stainless Steel Threaded Silencer Male NPT	
 p. L10	 p. L11	 p. L11	 p. L11	 p. L11	 p. L11	
Bins	16-CB 16 Compartment	24-CB 24 Compartment	ADJ-CB Adjustable Compartments	4CB-SR Slide Rack	LSR-STAND Stand	9-DC 9 Drawer
	 p. L12	 p. L12	 p. L12	 p. L12	 p. L13	 p. L13
18-DC 18 Drawer	24B-CABINET 24 Opening	40B-CABINET 40 Opening	PNEU-CAB Mobile Cabinet	Bags	4X6PSB Clear Plastic Bag	6X8PSB Clear Plastic Bag
 p. L13	 p. L13	 p. L14	 p. L14		 p. L14	 p. L14
Copper Tubing	X50CT Coiled Copper Tubing					
 p. L14						

WARNING These products can expose you to chemicals including NICKEL or LEAD, which are known to the state of California to cause cancer, and LEAD which is known to cause birth defects or other reproductive harm. For more information go to www.P65Warnings.ca.gov.

Blow Guns

Controlled Pressure Blow Guns

Parker Controlled Pressure Blow Guns meet OSHA requirements (section 29 CFR 1910.242 paragraph b), and directive #100-1. "Compressed air shall not be used for cleaning purposes except where reduced to less than 30 psi, and then only with effective chip guarding and personal protective equipment."

Parker Controlled Pressure Blow Guns have a black epoxy coated zinc body and vented nozzles to prevent pressure build-up when dead ending occurs up to 150 PSI (10.3 bar).

SPECIFICATIONS		
PART NO.	MAXIMUM PRESSURE PSI (BAR)	WT. (LB) P/PIECE
410-S	150 (10.3)	.50
410-SV	150 (10.3)	.53
415-S	150 (10.3)	.48



410-S

Parker Controlled Pressure Blow Guns features thumb lever valve actuator and brass nozzle. Inlet port is 1/4" NPT.



410-SV

Parker Venturi Nozzle Controlled Pressure Blow Gun with thumb lever valve and large venturi side ports for high volume flow. Inlet port is 1/4" NPT.



415-S

Parker Controlled Pressure Blow Guns features push button valve actuator and brass nozzle. Inlet port is 1/4" NPT.



400-S-TIP

Blow Gun Replacement Tip

Full Pressure Blow Guns

The following Parker Blow Guns must have a pressure regulator setting below 30 psi to conform to OSHA safety requirements 29 CFR 1910.242 Paragraph b.

SPECIFICATIONS		
PART NO.	MAXIMUM PRESSURE PSI (BAR)	WT. (LB) P/PIECE
410	150 (10.3)	.48
410-N	150 (10.3)	.51
415-N	150 (10.3)	.49



410

Parker two way thumb lever valve has a zinc body with 1/4" NPT inlet and 1/8" NPSF outlet.



410-N

Parker thumb lever style Blow Gun features a zinc body, brass nozzle, and 1/4" NPT female inlet.



415-N

Parker Blow Gun features a push button style actuator, zinc body with a brass nozzle and 1/4" NPT female inlet.

Note: Standard Gun without nozzle.

WARNING These products can expose you to chemicals including NICKEL or LEAD, which are known to the state of California to cause cancer, and LEAD which is known to cause birth defects or other reproductive harm. For more information go to www.P65Warnings.ca.gov.



BG Series Blow Guns

Made from impact resistant plastic, BG Series blow guns are durable and versatile. Extended nozzles allow air to be directed where it is required. The pistol grip trigger allows greater control over the amount of air delivered. Combined, these two features provide superior performance in a light weight, ergonomically designed package.

Nozzles are available in short and extended versions and most models meet OSHA directives on the use of compressed air for cleaning purposes. OSHA directive #100-1 states that “when dead ending occurs a static pressure at the main orifice shall not exceed 30 psi.” For those blow guns that do not meet this requirement, OSHA requires that “compressed air shall not be used for cleaning purposes except where reduced to less than 30 psi, and then only with effective

chip guarding and personal protective equipment” (section 29 CFR 1910.242 paragraph b). Please refer to the blow gun descriptions below for compatibility with OSHA directive #100-1.

Nozzle configurations are designed for maximum flexibility. Applications with special requirements may find the BG443-NBL with a 1/8” NPT fitting convenient for adapting existing nozzles or extra-long extensions. For information on specials or made-to-order blow gun nozzles, please contact the Quick Coupling Division.

- Easy to control variable flow pistol grip trigger.
- Nozzles available that meet OSHA requirements.
- Lightweight ergonomical design.
- Bodies are constructed of impact resistant plastic.

SPECIFICATIONS	
RATED PRESSURE PSI	175 (12.0 bar)
TEMPERATURE RANGE	TO +120° F (+48.8° C)
INLET PORT	1/4” NPTF

NOMENCLATURE	
EXAMPLE: BG442-SBL	ATTRIBUTE:
BG	BG SERIES BLOW GUN
4	INLET PORT IN 16THS
42	NOZZLE STYLE 41 - EXTENDED 42 - EXTENDED (OSHA) 43 - 1/8” FNPT 44 - SHORT (OSHA)
S	MEETS OSHA REQUIREMENTS S - YES N - NO
BL	COLOR BL - BLACK

BG441-NBL BG Series Blow Gun

PART NO.	NOZZLE	MEETS OSHA REQUIREMENTS
BG441-NBL	EXTENDED	NO



BG443-NBL BG Series Blow Gun

PART NO.	NOZZLE	MEETS OSHA REQUIREMENTS
BG443-NBL	1/8” FEMALE NPT	NO



BG442-SBL BG Series Blow Gun

PART NO.	NOZZLE	MEETS OSHA REQUIREMENTS
BG442-SBL	EXTENDED	YES



BG444-SBL BG Series Blow Gun

PART NO.	NOZZLE	MEETS OSHA REQUIREMENTS
BG444-SBL	VORTEC	YES



WARNING These products can expose you to chemicals including NICKEL or LEAD, which are known to the state of California to cause cancer, and LEAD which is known to cause birth defects or other reproductive harm. For more information go to www.P65Warnings.ca.gov.



New “Energy Saving” Flow Reducer System

- The flow reducer system allows for 40% savings in air consumption and guarantees stable flow, max 120 NI/min
- Can be adapted to all available interchangeable nozzles
- Available in a lower connection, threaded 1/4 NPT or 1/4 BSPP
- When combined with a specific interchangeable nozzle, the “energy saving” blow gun complies to OSHA 1910.242(b) nozzle and or OSHA 1910.95(b), addressing reduced pressure when in close proximity to an obstacle, chip guarding and noise level.

0653 Flow Reducer Blowgun NPT/BSPP

PART NO.	C NPT	C1	F IN	H1 IN	H2 IN	L1 IN	L2 IN	WT OZ
0653 66 14	1/4	M12X1.25	.79	4.60	1.34	5.78	.060	6.35

PART NO.	C BSPP	C1	F IN	H1 IN	H2 IN	L1 IN	L2 IN	WT KG
0653 66 13	G1/4	M12X1.25	20	117	34	147	1.5	.180

Combined with the osha 1910.242(B) nozzle, when in close proximity to an obstacle, the flow is deviated to reduce pressure to 0.5 Bar at the end of the nozzle.

The flow reducer system allows for 40% savings in air consumption and guarantees stable flow max 120 nl/m

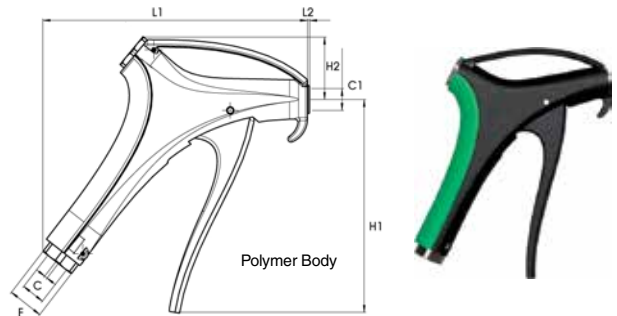

0652-0655 Progressive Control Blowgun BSPP

PART NO.	C BSPP	C1	F MM	H1 MM	H2 MM	L1 MM	L2 MM	WT KG
0652 66 13	G1/4	M12X1.25	17	128	14	120	1.5	.161
0655 66 13	G1/4	M12X1.25	20	117	37	145	2	.014

Choose from the wide range of interchangeable nozzles to have the right tool for the job - please refer to pages L8 and L9

0652 66 13 - lower connection
0655 66 13 - upper connection

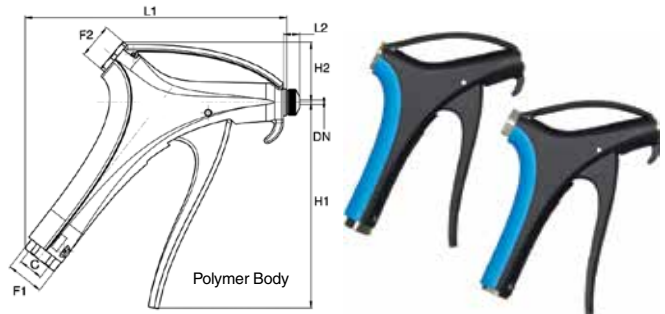

0656-0657 Progressive Control Blowgun Short Angled Nozzle NPT/BSPP

PART NO.	C NPT	C1	F IN	H1 IN	H2 IN	L1 IN	L2 IN	WT OZ
0656 66 13	1/4	M12X1.25	17	4.99	.55	4.68	.06	5.97

PART NO.	C BSPP	C1	F IN	H1 IN	H2 IN	L1 IN	L2 IN	WT KG
0657 66 13	G1/4	M12X1.25	17	128	14	120	1.5	.169

0656 66 13 - lower connection
0657 66 13 - upper connection

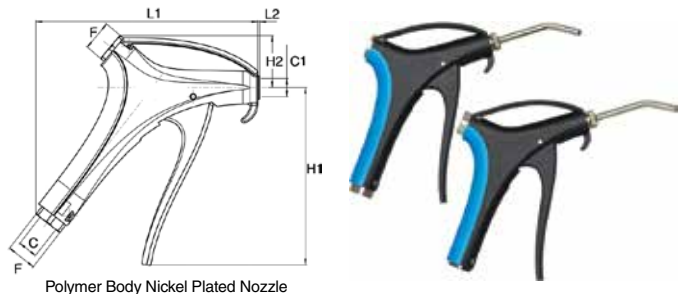

WARNING These products can expose you to chemicals including NICKEL or LEAD, which are known to the state of California to cause cancer, and LEAD which is known to cause birth defects or other reproductive harm. For more information go to www.P65Warnings.ca.gov.

0690 03 Straight Tube Nozzle Long

PART NO.	C METRIC	DN	G IN	L IN	L1 IN	WT OZ
0690 03 00	M12X1.25	2.5	.59	13	12	2.09
SPREAD OF CONE	MAX FLOW TOLERANCE ± 10%		NOISE LEVEL ISO15744			
21°	365 NI/MIN		83 dBA			

- OSHA 1910.95 (b) conforming
- Directive 2003/10/EC*

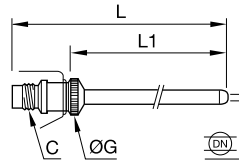

0690 04 Straight Tube Nozzle Short

PART NO.	C METRIC	DN	G IN	L IN	L1 IN	WT OZ
0690 04 00	M12X1.25	2.5	.59	4	3	1.13
SPREAD OF CONE	MAX FLOW TOLERANCE ± 10%		NOISE LEVEL ISO15744			
21°	385 NI/MIN		82 dBA			

- OSHA 1910.242 (b) conforming
- OSHA 1910.95 (b) conforming
- Directive 2003/10/EC*

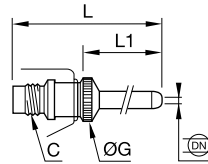

0690 05 Angled Tube Nozzle Long

PART NO.	C METRIC	DN	G IN	L IN	L1 IN	WT OZ
0690 05 00	M12X1.25	2.5	.59	12.4	11.5	2.09
SPREAD OF CONE	MAX FLOW TOLERANCE ± 10%		NOISE LEVEL ISO15744			
21°	330 NI/MIN		82 dBA			

- OSHA 1910.95 (b) conforming
- Directive 2003/10/EC*

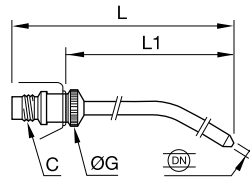

0690 06 Angled Tube Nozzle Short

PART NO.	C METRIC	DN	G IN	L IN	L1 IN	WT OZ
0690 06 00	M12X1.25	2.5	.59	3.7	2.75	1.13
SPREAD OF CONE	MAX FLOW TOLERANCE ± 10%		NOISE LEVEL ISO15744			
21°	565 NI/MIN		86 dBA			

- OSHA 1910.242 (b) conforming
- OSHA 1910.95 (b) conforming
- Directive 2003/10/EC*

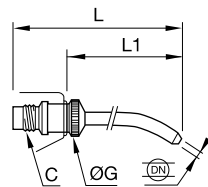

* Hearing protectors should always be worn when exposure to noise lasts longer than 8 hours.

WARNING These products can expose you to chemicals including NICKEL or LEAD, which are known to the state of California to cause cancer, and LEAD which is known to cause birth defects or other reproductive harm. For more information go to www.P65Warnings.ca.gov.

0690 08 Coanda Effect Nozzle

PART NO.	C METRIC	L IN	L1 IN	WT OZ
0690 08 00	M12X1.25	1.87	1.02	1.06
SPREAD OF CONE	MAX FLOW TOLLERANCE ± 10%	NOISE LEVEL ISO15744		
20°	240 NI/MIN	73 dBA		

- OSHA 1910.242 (b) conforming
- OSHA 1910.95 (b) conforming
- Directive 2003/10/EC*

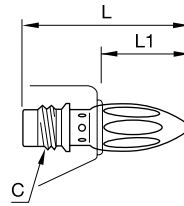

0690 09 Air Screen Nozzle

PART NO.	C METRIC	DN	G IN	L IN	L1 IN	WT OZ
0690 09 00	M12X1.25	2	1.18	1.59	.73	.68
SPREAD OF CONE	MAX FLOW TOLLERANCE ± 10%	NOISE LEVEL ISO15744				
JET 24° SCREEN 140°	650 NI/MIN	86 dBA				

- OSHA 1910.242 (b) conforming
- OSHA 1910.95 (b) conforming
- Directive 2003/10/EC*

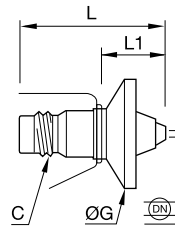

0690 10 Booster Nozzle

PART NO.	C METRIC	DN	G IN	L IN	L1 IN	WT OZ
0690 10 00	M12X1.25	2.5	.59	2.52	1.65	1.22
SPREAD OF CONE	MAX FLOW TOLLERANCE ± 10%	NOISE LEVEL ISO15744				
28°	335 NI/MIN	99 dBA				

- OSHA 1910.95 (b) conforming
- Directive 2003/10/EC*

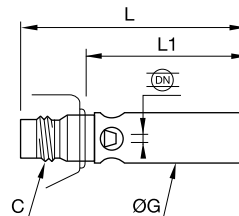

0690 11 Booster Nozzle with Air Screen

PART NO.	C METRIC	DN	G IN	G1 IN	L IN	L1 IN	WT OZ
0690 11 00	M12X1.25	2.5	1.18	.59	2.99	2.13	1.48
SPREAD OF CONE	MAX FLOW TOLLERANCE ± 10%	NOISE LEVEL ISO15744					
JET 26° SCREEN 140°	625 NI/MIN	86 dBA					

- OSHA 1910.242 (b) conforming
- OSHA 1910.95 (b) conforming
- Directive 2003/10/EC*

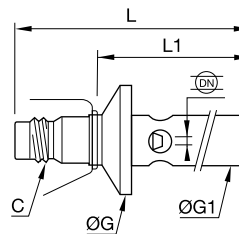

* Hearing protectors should always be worn when exposure to noise lasts longer than 8 hours.

WARNING These products can expose you to chemicals including NICKEL or LEAD, which are known to the state of California to cause cancer, and LEAD which is known to cause birth defects or other reproductive harm. For more information go to www.P65Warnings.ca.gov.

Silencers

Technical Specification of Silencers:

MATERIAL	WORKING PRESSURE	WORKING TEMPERATURE
SINTERED BRONZE	175 PSI (12.0 bar)	-4° to +300° F (-20° to +148.8° C)
POLYETHYLENE	145 PSI (9.9 bar)	-14° to +175° F (-25.5° to +79.4° C)
STAINLESS STEEL	175 PSI (12.0 bar)	-4° to +355° F (-20° to +179.4° C)

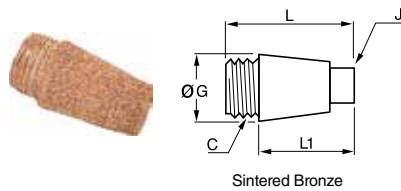

0673 0610 0670 Threaded Silencer UNF, NPT or BSPP

PART NO.	C UNF/NPT	J IN	G IN	L IN	L1 IN	WT OZ
0673 00 20*	10-32	.27	.31	.34	.18	.07
0610 00 11	1/8	.31	.42	.89	.71	.21
0610 00 14	1/4	.39	.59	1.10	.87	.46
0610 00 18	3/8	.51	.75	1.42	1.14	.85
0610 00 22	1/2	.59	.91	1.73	1.42	1.48

PART NO.	C BSPP	J MM	G MM	L MM	L1 MM	WT KG
0670 00 10	G1/8	7	12	20.5	15	.007
0670 00 13	G1/4	8	15	24.5	18.5	.013
0670 00 17	G3/8	10	19	37	29	.033
0670 00 21	G1/2	14	23	40	31	.049
0670 00 27	G3/4	16.5	29.5	51	40.5	.092
0670 00 34	G1	20	36	60	49.5	.140

* Brass Body

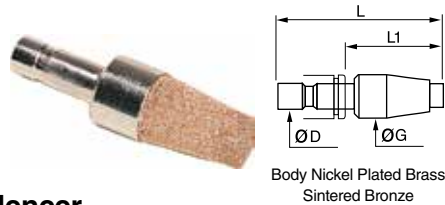

0671 Plug-In Silencer

PART NO.	C	G MM	L MM	L1 MM	WT OZ
0671 04 00	4	13	41.5	24.5	.015
0671 06 00	6	15	48	29	.023
0671 08 00	8	15	49.5	29.5	.024
0671 10 00	10	19.5	68	43.5	.054
0671 12 00	12	20	68.5	43	.055

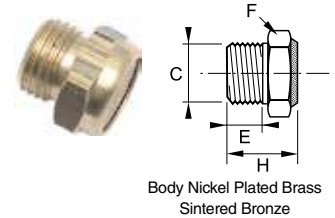

0673 Compact Threaded Silencer Male BSPP, M5

PART NO.	C	E MM	F MM	H MM	WT OZ
0673 00 10	G1/8	4	13	12	.006
0673 00 13	G1/4	6	16	16	.012
0673 00 17	G3/8	8	19	17	.022
0673 00 19	M5X0.8	8	8	8.5	.001
0673 00 20	UNF 10-32	4	6	11	.006
0673 00 21	G1/2	9	24	18	.037

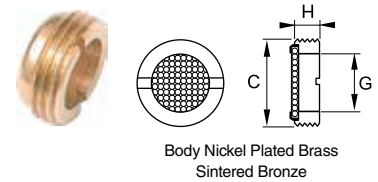

0677 Miniature Silencer BSPP

PART NO.	C	G MM	H MM	WT OZ
0677 00 10	G1/8	5.5	4	.002
0677 00 13	G1/4	6	4.5	.003
0677 00 17	G3/8	9.5	5	.006
0677 00 21	G1/2	12.5	5.5	.012
0677 00 27	G3/4	19	6	.014
0677 00 34	G1	24	7	.025

WARNING These products can expose you to chemicals including NICKEL or LEAD, which are known to the state of California to cause cancer, and LEAD which is known to cause birth defects or other reproductive harm. For more information go to www.P65Warnings.ca.gov.

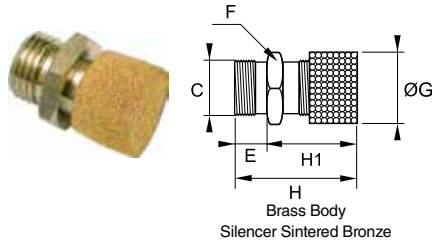

0614 0672 Flow Control Silencer Male NPT, BSPP

PART NO.	C NPT	E	F MM	G	H MIN	H MAX	H1	WT OZ
0614 00 11	1/8	.31	14	.55	.94	1.06	.71	.42
0614 00 14	1/4	.31	17	.67	.98	1.10	.75	.81
0614 00 18	3/8	.39	22	.87	1.18	1.30	.94	1.16
0614 00 22	1/2	.47	27	1.06	1.54	1.65	1.30	1.55

PART NO.	C BSPP	E MM	F MM	G MM	H MIN	H MAX	H1 MM	WT KG
0672 00 10	1/8	8	14	14	24	27	18	.012
0672 00 13	1/4	8	17	17	25	28	19	.023
0672 00 17	3/8	10	22	22	30	33	24	.033
0672 00 21	1/2	12	27	27	39	42	33	.044

Consult us for flow characteristics

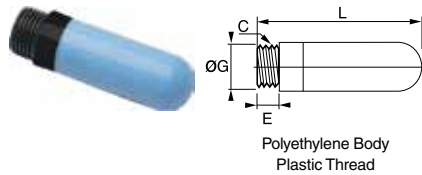

0611 0674 Threaded Silencer NPT, BSPP, M5

PART NO.	C NPT	E IN	G IN	L IN	WT OZ
0611 00 11	1/8	.24	.49	1.34	.07
0611 00 14	1/4	.28	.61	1.67	.11
0611 00 18	3/8	.45	.73	2.66	.21
0611 00 22	1/2	.43	.93	3.07	.35

PART NO.	C BSPP	E MM	G MM	L MM	WT OZ
0674 00 19	M5X0.8	4	6.5	23	.001
0674 00 10	G1/8	6	12.5	34	.002
0674 00 13	G1/4	7	15.5	42.5	.003
0674 00 17	G3/8	11.5	18.5	67.5	.006
0674 00 21	G1/2	11	23.5	78	.010
0674 00 27	G3/4	15.5	38.5	131	.040
0674 00 34	G1	19.5	49	160	.050

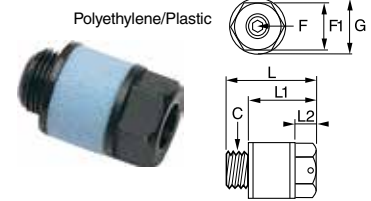

0676 Flow Control Silencer BSPP

PART NO.	C BSPP	F MM	F1 MM	G MM	L MM	L1 MM	L2 MM	WT OZ
0676 00 10	G1/8	2.5	13	15	20.5	14.5	5	.002
0676 00 13	G1/4	4	15	18	29	22	7	.007

NO. OF TURNS	FLOW SCFM AT 87 PSI									NOISE LEVEL dBA*	
	0	1	2	3	4	5	6	7	8		9
0676 00 10	0	1.06	3.2	7.4	11.8	13	13.8	13.8	13.9	13.9	82
0676 00 13	0	.78	.88	1.77	12	26.5	33	34.6	35.3	36	84

* dBA at 87 PSI and 12 SCFM

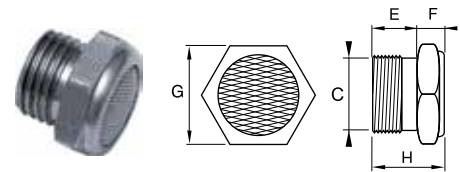

0682 Stainless Steel Threaded Silencer Male BSPP

PART NO.	C BSPP	E MM	F MM	G MM	H MM	WT KG
0682 00 10	G1/8	8	7	14	15	.009
0682 00 13	G1/4	8	7	17	15	.013
0682 00 17	G3/8	10	8	22	18	.020
0682 00 21	G1/2	12	10	27	22	.038
0682 00 27	G3/4	15	12	32	27	.066
0682 00 34	G1	18	14	38	32	.118

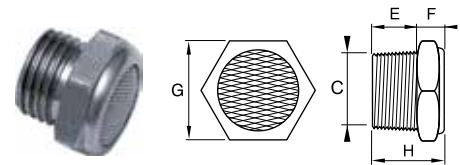

0683 Stainless Steel Threaded Silencer Male NPT

PART NO.	C NPT	E IN	F IN	G MM	H IN	WT KG
0683 00 11	1/8	.28	.28	14	.55	.35
0683 00 14	1/4	.43	.28	17	.71	.53
0683 00 18	3/8	.43	.31	22	.75	.81
0683 00 22	1/2	.59	.39	27	.98	1.55

WARNING These products can expose you to chemicals including NICKEL or LEAD, which are known to the state of California to cause cancer, and LEAD which is known to cause birth defects or other reproductive harm. For more information go to www.P65Warnings.ca.gov.

16 Compartment Large Scoop Box

- Prime cold rolled steel outer shell
- High impact styrene insert with 16 compartments
- Scooped bottom compartments for easy part removal
- Full piano hinge on cover provides rigidity
- Positive pull-down catch keeps cover tightly closed to prevent part migration
- Handle allows for easy transport
- Durable gray powder coat finish

PART NUMBER	DIMENSIONS (IN.)		
	WIDTH	DEPTH	HEIGHT
16-CB	18	12	3



24 Compartment Large Scoop Box

- Prime cold rolled steel outer shell
- High impact styrene insert with 24 compartments
- Scooped bottom compartments for easy part removal
- Full piano hinge on cover provides rigidity
- Positive pull-down catch keeps cover tightly closed to prevent part migration
- Handle allows for easy transport
- Durable gray powder coat finish

PART NUMBER	DIMENSIONS (IN.)		
	WIDTH	DEPTH	HEIGHT
24-CB	18	12	3



ADJ-CB

- Prime cold rolled steel outer shell
- High impact styrene insert with 4 fixed vertical compartments and 9 moveable dividers adjustable on 1" centers
- Full piano hinge on cover provides rigidity
- Positive pull-down catch keeps cover tightly closed to prevent part migration
- Durable gray powder coat finish

PART NUMBER	DIMENSIONS (IN.)			COMPARTMENTS
	WIDTH	DEPTH	HEIGHT	
ADJ-CB	18	12	3	ADJUSTABLE



Easy Glide Slide Rack (Holds 4 16-CB or 24-CB per rack)

- Sturdy construction using prime cold-rolled steel
- Each cradle holds up to 40 lbs
- Easy glide slides allow boxes to move in and out smoothly
- Center braces on cradles provide extra rigidity
- Reinforced rack keeps boxes level
- Boxes can be easily removed for transport to work areas
- Base and locking hinge are available as accessories
- Durable gray powder coat finish

PART NUMBER	DIMENSIONS (IN.)		
	WIDTH	DEPTH	HEIGHT
4CB-SR	20	15.75	15



WARNING These products can expose you to chemicals including NICKEL or LEAD, which are known to the state of California to cause cancer, and LEAD which is known to cause birth defects or other reproductive harm. For more information go to www.P65Warnings.ca.gov.

LSR-Stand

- Sturdy all steel construction
- Raises units 15 inches off the floor
- Legs attach easily using fasteners provided
- Durable gray powder finish



PART NUMBER	DIMENSIONS (IN.)		
	WIDTH	DEPTH	HEIGHT
LSR-STAND	20 5/8	16 1/4	15 5/8

9 Drawer Cabinet

- Prime cold rolled steel construction
- High density drawer cabinet, easy to store large quantities of small parts
- Drawers feature interlocking design for superior strength
- Drawers have full width handles and easy glide runners
- Each drawer includes 2 easy label dividers, which are adjustable on 1" centers
- Cabinets can be stacked using mounting holes
- Durable gray powder coat finish
- Ships fully assembled



PART NUMBER	DIMENSIONS (IN.)			DRAWER DIMENSIONS (IN.)		
	WIDTH	DEPTH	HEIGHT	WIDTH	DEPTH	HEIGHT
9-DC	17.25	11.625	10.875	5.375	11.25	2.75

18 Drawer Cabinet

- Prime cold rolled steel construction
- High density drawer cabinet, easy to store large quantities of small parts
- Drawers feature interlocking design for superior strength
- Drawers have full width handles and easy glide runners
- Each drawer includes 2 easy label dividers, which are adjustable on 1" centers
- Cabinets can be stacked using mounting holes
- Durable gray powder coat finish
- Ships fully assembled



PART NUMBER	DIMENSIONS (IN.)			DRAWER DIMENSIONS (IN.)		
	WIDTH	DEPTH	HEIGHT	WIDTH	DEPTH	HEIGHT
18-DC	17.25	11.625	21.25	5.375	11.25	2.75

24 Opening Bin

- All welded, prime cold rolled steel
- Fully hemmed 1 1/8" bin fronts to hold labels and retain parts
- Roll-formed sides for increased strength and stability
- Ribbed and hemmed dividers provide added strength
- Modular with most 12" deep bins and drawer cabinets; mounting holes are located at both the top and bottom
- Durable gray powder coat finish
- Ships fully assembled



PART NUMBER	DIMENSIONS (IN.)			BIN DIMENSIONS (IN.)		
	WIDTH	DEPTH	HEIGHT	WIDTH	DEPTH	HEIGHT
24B-CABINET	33.75	12	23.875	5.375	11.875	5.5

WARNING These products can expose you to chemicals including NICKEL or LEAD, which are known to the state of California to cause cancer, and LEAD which is known to cause birth defects or other reproductive harm. For more information go to www.P65Warnings.ca.gov.

40 Opening Bin

- All welded, prime cold rolled steel
- Fully hemmed 1 1/8" bin fronts to hold labels and retain parts
- Roll-formed sides for increased strength and stability
- Ribbed and hemmed dividers provide added strength
- Modular with most 12" deep bins and drawer cabinets; mounting holes are located at both the top and bottom
- Durable gray powder coat finish
- Ships fully assembled



PART NUMBER	DIMENSIONS (IN.)			BIN DIMENSIONS (IN.)		
	WIDTH	DEPTH	HEIGHT	WIDTH	DEPTH	HEIGHT
40B-CABINET	35.25	12	21.50	4	11.875	4.5

Pneumatic Cabinet

- High quality all-steel construction
- Partitioning slots provide flexibility for customization
- Drawer locks limit access to prevent loss and improve safety when moved
- Drawer interlock prevent opening multiple drawers that could cause accidental tip over
- Available fitting and connector labels with photos make easy selection and restock easy
- Locking 4" heavy-duty casters
- Retainer top with a non-skid mat work surface



PART NUMBER	DIMENSIONS (IN.)			DRAWERS
	WIDTH	DEPTH	HEIGHT	
PNEU-CAB	22.1875	28.5	39.5	5-3" AND 1-9"

Clear Plastic Shipping Bags PSB

Reusable, clear polyethylene, zip-lock style bags with panels for marking part number, quantity, and availability information. Features easy visual part identification. Ideal for custom packaging of less than box quantities.

PART NO.	SIZE
4X6PSB	4" X 6"
6X8PSB	6" X 8"



Copper Tubing

Copper tubing meets A.S.T.M. specification B-280 (copper tube for refrigeration field service)

PART NO.	TUBE O.D.	TUBE I.D.	WALL THICKNESS	FEET PER COIL
50CT-2-30	1/8	.065	.030	50
50CT-3-30	3/16	.128	.030	50
50CT-4-30	1/4	.190	.030	50
50CT-5-32	5/16	.249	.032	50
50CT-6-32	3/8	.311	.032	50
50CT-8-32	1/2	.436	.032	50



WARNING These products can expose you to chemicals including NICKEL or LEAD, which are known to the state of California to cause cancer, and LEAD which is known to cause birth defects or other reproductive harm. For more information go to www.P65Warnings.ca.gov.



Tube Fabricating Equipment

Tube Cutters

Tube Benders

Flaring Tools

In-Ex[®] Tube Deburring Tool





IMPERIAL

<p>Tube Cutter</p>	<p>TC-1000-BPD 1/8" - 1 1/8"  p. M5</p>	<p>TC-1050-BPD 1/8" - 5/8"  p. M5</p>	<p>174-F-BPD 3/8" - 1 1/8"  p. M5</p>	<p>218B-BPD 1/8" - 1 1/8"  p. M6</p>	<p>PTC-001 Plastic Tube cutter  p. M6</p>	<p>3000 71 11 For tubing & push-on hose  p. M6</p>	
<p>Tube Benders</p>	<p>367-FH-BPD Lever Type  p. M7</p>	<p>368-FH-BPD Lever Type  p. M7</p>	<p>102-F-XX-BPD Spring Type  p. M7</p>				
<p>Flaring Tools</p>	<p>525-F-BPD Flaring Kit  p. M8</p>	<p>93-FB-BPD Flaring Tool  p. M8</p>	<p>945TH-BPD Flaring Tool  p. M8</p>	<p>Tube Deburring Tool</p>		<p>226-BPD Deburring Tool  p. M8</p>	<p>208-FSS-BPD Stainless Deburring Tool  p. M8</p>
<p>Replacement Parts</p>	<p>S75015-BPD Cutting Wheel  p. M5</p>	<p>S75046-BPD Cutting Wheel for Stainless  p. M5</p>	<p>S32633-BPD Cutting Wheel  p. M5</p>	<p>PTC-001RB Replacement Blades  p. M6</p>	<p>226RB-BPD Replacement Blades  p. M8</p>		

WARNING These products can expose you to chemicals including NICKEL or LEAD, which are known to the state of California to cause cancer, and LEAD which is known to cause birth defects or other reproductive harm. For more information go to www.P65Warnings.ca.gov.

Tube Cutters

For hard or soft copper, aluminum, brass, thin wall steel, stainless steel, monel, titanium and other metal tubing. Rollers have flare cut-off groove, fold away reamer and spare cutting wheel.



PART NO.	DESCRIPTION
TC-1000-BPD	For 1/8" to 1 1/8" (4 to 28 mm) O.D. tubing, (1/8" to 1" nom.). Length: 4 15/16" Weight: 6 1/2 oz.
REPLACEMENT PARTS:	
S75015-BPD	Standard cutting wheel
S75046-BPD	Cutting wheel for stainless steel and hard temper tubing

PART NO.	DESCRIPTION
TC-1050-BPD	Requires only 1 1/4" swing radius. (Requires only 1 3/8" swing radius with 5/8" tube.) Repositioned rollers to bottom of tool allows for easier cutter engagement on tubing. Enclosed feed-screw minimized contamination, assuring continued free operation. Redesigned feed mechanism improves overall cutting action. Size: 1 3/4" x 1 1/4" x 1/2" Weight: 2 1/2 oz.
S32633-BPD	Cutting wheel for TC-1050-BPD

PART NO.	DESCRIPTION
174-F-BPD	Requires only 1 15/16" swing radius. (Requires only 2 1/4" swing radius with 1 1/8" tube.) Size: 2 11/16" x 2 1/32" x 1 1/8" Weight: 5 oz.
REPLACEMENT PARTS:	
S75015-BPD	Cutting wheel
S75046-BPD	Cutting wheel for stainless steel and hard temper tubing

WARNING These products can expose you to chemicals including NICKEL or LEAD, which are known to the state of California to cause cancer, and LEAD which is known to cause birth defects or other reproductive harm. For more information go to www.P65Warnings.ca.gov.

Kloskut Tube Cutters

Adjustable tube cutters to produce square cut ends with no external burr and minimum internal burring when used on fully annealed copper, brass, aluminum, and steel tubing. Features a hardened and burnished tool-steel cutting wheel, flare cut-off grooves in rollers for removal of old flares, swing-away reamer for removing internal burrs. Handle feeds and adjusts cutting wheel to uniformly cut tubing as the cutter is rotated.

NOTE: Tube cutters are not recommended for use with stainless steel tubing because of the work hardening effect. The use of a hacksaw with a “Tru-Kut” Sawing Vise or a rotary teeth saw is best recommended for stainless steel.



PART NO.	DESCRIPTION
218B-BPD	Medium Kloskut For tubing sizes -2 (1/8" O.D.) to -18(1 1/8" O.D.) Weighth: 11 oz.



PART NO.	DESCRIPTION
PTC-001	Plastic Tube Cutter May be used with polyethylene, Polypropylene, nylon and other thermoplastic tubing. For tube O.D. sizes 1/8" to 1/2"
PTC-001RB	Replacement blades



PART NO.	DESCRIPTION
3000 71 11	Tube cutter for tubing & push-on hose For hoses up to 1" (25mm) Weighth: 1.09 oz.
3000 71 11 05	Replacement blades

WARNING These products can expose you to chemicals including NICKEL or LEAD, which are known to the state of California to cause cancer, and LEAD which is known to cause birth defects or other reproductive harm. For more information go to www.P65Warnings.ca.gov.

Tube Benders, Lever Type

For soft copper, aluminum, brass, steel and other metal tubing. Triple Header Benders Calibrated markings for making accurate left-hand, right-hand and offset bends. Ninety degree start requires less effort - making bending fast and easy.



PART NO.	DESCRIPTION
367-FH-BPD	For 1/8", 3/16" and 1/4" O.D. tubing, 9/16" radius to center of tube.
368-FH-BPD	For 1/4", 5/16" and 3/8" O.D. tubing, 15/16" radius to center of tube.

Metric Tube Benders

Triple Header Benders For annealed copper, aluminum, steel, stainless steel and hard copper tubing of bending temper. Lever type, multiple size benders. Calibrated markings for making accurate left-hand, right-hand, and offset bends. Ninety degree start requires less effort; makes bending fast and easy.



PART NO.	DESCRIPTION
367-FH-BPD	For 3, 4, 6 mm O.D. tubing, 14.2 mm radius to center of tube.
368-FH-BPD	For 6 and 8 mm O.D. tubing, 17.5 mm radius to center of tube.

Tube Benders, Spring Type

For soft copper and aluminum tubing. For 1/4" to 5/8" O.D. tubing. Tools allow hand bending of soft tubing to any shape without collapsing walls. Special spring steel, nickel finished. End belled for quick tube removal.



PART NO.	TUBE O.D. IN	LENGTH IN	WEIGHT OZ
102-F-04-BPD	1/4	10	3
102-F-06-BPD	3/8	10	4
102-F-08-BPD	1/2	12	6 1/2

WARNING These products can expose you to chemicals including NICKEL or LEAD, which are known to the state of California to cause cancer, and LEAD which is known to cause birth defects or other reproductive harm. For more information go to www.P65Warnings.ca.gov.

Flaring Tools



PART NO.	DESCRIPTION
525-F-BPD	Flares and burnishes 3/16" to 5/8" (5 to 16 mm) O.D. tubing. Unique, self-adjusting, tube holding mechanism permits use in tight quarters. Faceted, hard chrome finished cone rolls out and burnishes perfect 45° flare above the tube holding mechanism.
	Weight: 1 3/4 lbs.



PART NO.	DESCRIPTION
93-FB-BPD	For 3/16", 1/4", 5/16", 3/8" and 1/2" O.D. tubing. Recommended for Bundy, GM and other brazed or welded soft steel tubing (wall thickness to .035"). Also makes single or double flares in soft copper or aluminum tubing. Forged steel yoke; swivel-type hard chrome-finished flaring cone.
	Weight: 3 lbs.



PART NO.	DESCRIPTION
945TH-BPD	Rolo-flair® Manual Rotary Flaring Tool For soft metal tubing. Precision burnished 45° flares in tube sizes from 2 (1/8" O.D.) to 12 (3/4" O.D.) with an easy turn of the handle. For copper and aluminum alloy.
	Weight: 2 1/2 lbs.

In-Ex® Tube Deburring Tool



PART NO.	DESCRIPTION
226-BPD	Insert tube into the convexed end of the In-Ex for inside deburring and the opposite end for outside deburring. Rotate in either direction. Replacement blades can be ordered. See bulletin 4391-B226 for details.
	Weight: 10 oz.
226RB-BPD	Replacement Blades
208-FSS-BPD	Reamer for aircraft grade stainless steel tubing. Black finish
	Weight: 10 oz.

WARNING These products can expose you to chemicals including NICKEL or LEAD, which are known to the state of California to cause cancer, and LEAD which is known to cause birth defects or other reproductive harm. For more information go to www.P65Warnings.ca.gov.



General Technical

Tubing Compatibility Chart

Tubing Compatibility Chart

Manufacturing Techniques

Tube Line Fabrication Guide
for Leak Free Systems

Thread Specifications

Flaring Instructions

Thread Designations and Standards for
Threads Used in Fluid Connectors

Straight Thread Size Comparison Chart

S.A.E. Part Index

SAE Standards

U.L. Listed Fittings

Flow Curves

Flare and Thread Profiles

Pressure Conversions

English/Metric Conversions

Assembly Guides

Fluid Compatibility Guide



Tubing Compatibility Chart

Nomenclature		Soft Metal Tubing			Parflex Thermoplastic Tubing												
		Copper	Aluminum	Steel	Industrial Tubing Series (Outside Diameter Shown)												
					Polyethylene E & EB Inch (4,5,6,8,10) Metric (6,8,10,12)	Polyethylene PEFR Inch (2,5,4,6,8)	Polyethylene HDPE Inch (4,6)	Nylon N Inch (2,2.5,3,4,5,6,8) Metric (4mm - 20mm)	Nylon PAT Inch (2,4,6,8,10,12)	Nylon NR Inch (2,3,4,5,6,8)	Nylon NTNA Inch (2,2.5,3,4,5,6,8)	Polypropylene PP & PPB Inch (2,3,4,5,6,8,10)	Polyurethane U & UM (90 - 95 Shore A) Inch (2,3,4,6,8,9,12) Metric (4,6,8,10,12)	Polyurethane HU & HJM (>95 Shore A) Inch (2,2.5,4,6,8,12) Metric (4,6,8,10,12)	Polyurethane HUFFR (Weld Tubing) Inch (4,6,8)	Clear Vinyl Inch (1/8" - 2 1/2")	
Product Sizes (inch)																	
Compression & Flare	Compression Inch (2,3,4,5,6,7,8,10,12)	BS	BS		PS TS	PS TS	PS TS	PS TS	PS TS	PS TS		PS TS					
	Compress-Align Inch (2,3,4,5,6,8,10,12,14,16)				TS	TS	TS	TS	TS	TS		TS					
	Metric Compression Metric (4,5,6,8,10,12,14,16,18,20,22,25,28)				TS			TS		TS		TS		TS			
	Poly-Tite Inch (4,5,6,8)	BS						BS				BS					
	Hi-Duty Inch (2,3,4,5,6,8,10)				TS	TS	TS	TS	TS	TS		TS					
	45 degree flare Inch (2,3,4,5,6,8,10,12,14)																
	Inverted Flare Inch (2,3,4,5,6,8,10,12)																
	Fast & Tite Inch (4,5,6,8,10)												TS	TS			TS
Push-to-Connect	Flow Controls Inch (2,2.5,4,5,6,8) Metric (4,6,8,10,12)																
	Prestolok Brass Inch (2,2.5,3,4,5,6,8)																
	Prestolok Composite Inch (2,2.5,3,4,5,6,8,10) Metric (3,4,6,8,10,12,14,16)																
	Prestolok All-Metal Inch (2,5,4,5,6,8) Metric (4,6,8,10,12,14)																
	Prestolok Stainless Inch (2,5,3,4,5,6,8) Metric (4,6,8,10,12)																
	Liquifit Inch (2,5,4,6,8) Metric (4,6,8,10,12)																
	TrueSeal Inch (4,5,6,8)	MG								MG			TS	TS			TS
Barb	Par-Barb Inch (2,3,4,5,6,8,10,12,16,20,24) Inside Diameter												CL			CL	
	Dubl-Barb Inch (2,5,4,6,8)																
	Hose Barb Inch (2,3,4,5,6,8,10,12,16) Inside Diameter															CL	
	Garden Hose															CL	
DOT Transportation	NTA Inch (3,4,6,8,10,12)																
	Transmission Fittings Inch (2,2.5)																
	Air Brake Inch (4,6,8,10,12,16)																
	Air Brake Hose Inch (6,8)																
	Vibra-Lok Inch (2,3,4,5,6,8,10,12)																
	Prestomatic Inch (4,6,8,10) Metric (6,8,10,12,16)																
	PTC Inch (2,5,3,4,6,8,10,12)																
	SAE Cartridges Inch (4,6,8,10)																

Tubing Compatibility Chart

Parflex Thermoplastic Tubing							IHP/HPD Hose		Nomenclature	Product Sizes (inch)	
Transportation Tubing				Fluoropolymer Tubing			GPH General Purpose Inch (3, 4, 6, 8, 12) Inside Diameter	Parker 271 hose (SAE J1402) Inch (6, 8) Inside Diameter			
PFT Air Brake (SAE J844) Inch (2, 2.5, 3, 4, 5, 6, 8, 10, 12)	Air Brake DIN 74324 (Nylon 12) Metric (4, 6, 8, 10, 12, 15, 16, 18)	PFT Diesel Fuel Sizes 4, 6, 8, 10, 12	HTFL Diesel Fuel Sizes 4, 6, 8, 10, 12	PFA Inch (3/32" - 1") Metric (4mm - 12mm)	FEP Inch (1/8" - 1") Metric (3mm - 12mm)	PTFE Inch (3/32" - 1.1") Metric (3mm - 16mm)			PVDF Inch (2, 3, 4, 5, 6, 8, 10, 12, 16)		
				PS TS	PS TS	PS TS	PS TS		Compression Inch (2, 3, 4, 5, 6, 7, 8, 10, 12)	Compression & Flare	
				TS	TS	TS	TS		Compress-Align Inch (2, 3, 4, 5, 6, 8, 10, 12, 14, 16)		
				TS	TS	TS	TS		Metric Compression Metric (4, 5, 6, 8, 10, 12, 14, 16, 18, 20, 22, 25, 28)		
									Poly-Tite Inch (4, 5, 6, 8)		
									Hi-Duty Inch (2, 3, 4, 5, 6, 8, 10)		
									45 degree flare Inch (2, 3, 4, 5, 6, 8, 10, 12, 14)		
									Inverted Flare Inch (2, 3, 4, 5, 6, 8, 10, 12)		
									Fast & Tite Inch (4, 5, 6, 8, 10)	Push-to-Connect	
									Flow Controls Inch (2, 2.5, 3, 4, 5, 6, 8) Metric (4, 6, 8, 10, 12)		
									Prestolok Brass Inch (2, 2.5, 3, 4, 5, 6, 8)		
									Prestolok Composite Inch (2, 2.5, 3, 4, 5, 6, 8, 10) Metric (3, 4, 6, 8, 10, 12, 14, 16)		
									Prestolok All-Metal Inch (2.5, 4, 5, 6, 8) Metric (4, 6, 8, 10, 12, 14)		
									Prestolok Stainless Inch (2.5, 3, 4, 5, 6, 8) Metric (4, 6, 8, 10, 12)		
									Liquifit Inch (2.5, 4, 6, 8) Metric (4, 6, 8, 10, 12)		
				MG	MG	MG	MG		TrueSeal Inch (4, 5, 6, 8)	Barb	
								CL	Par-Barb Inch (2, 3, 4, 5, 6, 8, 10, 12, 16, 20, 24) Inside Diameter		
									Dubl-Barb Inch (2.5, 4, 6, 8)		
								CL	Hose Barb Inch (2, 3, 4, 5, 6, 8, 10, 12, 16) Inside Diameter		
									Garden Hose	DOT Transportation	
									NTA Inch (3, 4, 6, 8, 10, 12)		
									Transmission Fittings Inch (2, 2.5)		
									Air Brake Inch (4, 6, 8, 10, 12, 16)		
									Air Brake Hose Inch (6, 8)		
									Vibra-Lok Inch (2, 3, 4, 5, 6, 8, 10, 12)		
									Prestomatic Inch (4, 6, 8, 10) Metric (6, 8, 10, 12, 16)		
									PTC Inch (2.5, 3, 4, 6, 8, 10, 12)		
									SAE Cartridges Inch (4, 6, 8, 10)		

- Nomenclature**
- PS Plastic Sleeve & Tube Support Recommended
 - TS Tube Support Is Recommended
 - BS Brass Sleeve Recommended
 - CL Clamp Required
 - MG Metal Gripper Collet Recommended
 - Tube/Fitting Combination Compatible
 - Tube/Fitting Combination Not Compatible



Manufacturing Techniques

Parker Extruded fittings

Hexagon, round and shaped bars are extruded in the configuration required, drawn to size, cut to length and straightened. First a solid round billet (8 to 12 inches in diameter) is heated to the pliable state and forced by pressure of approximately 80,000 pounds per square inch through a die. The resulting continuous length of bar is cooled and then drawn through dies to the desired external size. (The drawing process also controls the temper.) After straightening, the bar is ready for machining.

The process produces a dense, nonporous material somewhat stronger in the longitudinal direction due to an orientated flow of the grain.

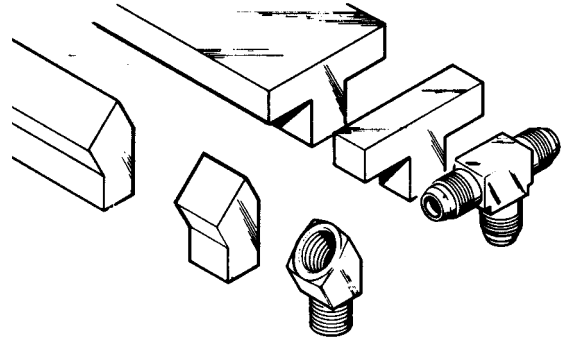

Material used for Parker Brass Fittings

(Reference SAE J461)

Straight bodies:	barstock CA 360 or CA 345
Shape bodies:	extruded barstock CA 360
Shape bodies:	forged CA 377
Nuts:	barstock CA 360
Nuts:	forged CA 377

Parker Forged Fittings

Material for forgings is extruded in round bars, cut to length and straightened. (At this point in the process, forging rod differs from round extruded machinable bars only in temper and chemical properties.) After straightening, the bars are cut again into slugs (short lengths), reheated to the pliable state and pressed under a pressure of approximately 25,000 pounds per square inch between upper and lower die cavities. After cooling the flash is trimmed away and the forging blank is ready for machining.

This process of forming under extreme pressure produces a uniformly dense material of exceptional strength. Because grain flow follows the contour, the fitting has high impact strength and is more resistant to mechanical shock and vibration.

Of the major brass fittings producers, only Parker offers elbows and tees machined from both extruded and forged shapes.

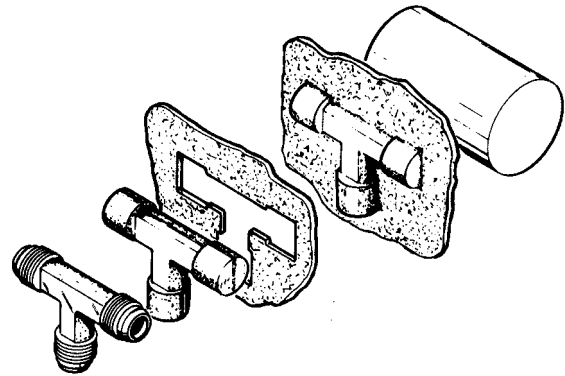

Tube Line Fabrication Guide for Leak Free Systems

Every hydraulic, pneumatic and lubrication system requires some form of tube line fabrication and fitting installation for completion. Proper fabrication and installation are essential for the overall efficiency, leak free performance, and general appearance of any system.

Start by planning ahead. After sizing the tube lines and selecting the appropriate style of fitting, consider the following in the design of your system:

1. Accessibility of joints
2. Proper routing of lines
3. Adequate tube line supports
4. Available fabricating tools

Routing of Lines

Routing of lines is probably the most difficult yet most significant of these system design considerations. Proper routing involves getting a connecting line from one point to another through the most logical path.

Always try to leave fitting joints as accessible as possible. Hard to reach joints are hard to assemble and tighten properly. Inaccessible joints are also more difficult and time consuming to service.

The most logical path should have the following characteristics:

- **Avoid excessive strain on joint** — A strained joint will eventually leak. (See Figures A14 through A21.)
- **Allow for expansion and contraction** — Use a “U” bend or a hose in long lines to allow for expansion and contraction. (See Figure A22.)
- **Allow for motion under load** — Even some apparently rigid systems do move under load. (See Figure A23.)
- **Get around obstructions without using excessive amount of 90° bends** — Pressure drop due to one 90° bend is greater than that due to two 45° bends. (See Figures A24 and A25.)
- Keep tube lines away from components that require regular maintenance. (See Figures A26 and A27.)
- Have a neat appearance and allow for easy troubleshooting, maintenance and repair. (See Figures A28 and A29.)

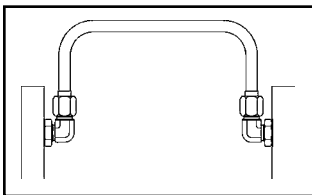

Fig. A14 — Correct Routing

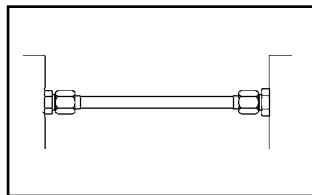

Fig. A15 — Incorrect Routing

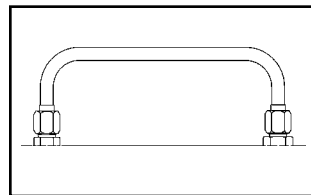

Fig. A18 — Correct Routing

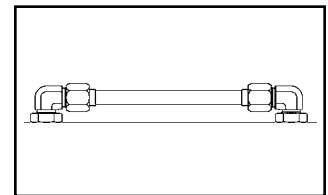

Fig. A19 — Incorrect Routing

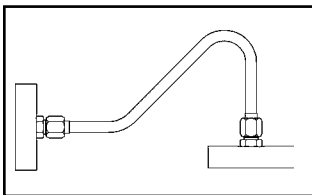

Fig. A16 — Correct Routing

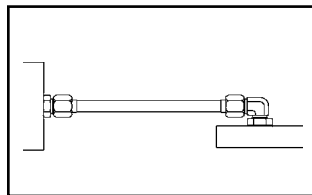

Fig. A17 — Incorrect Routing

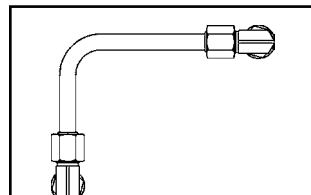

Fig. A20 — Correct Routing

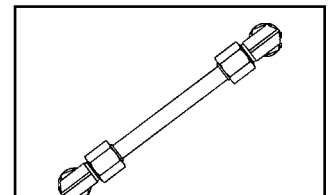

Fig. A21 — Incorrect Routing

(continued next page)

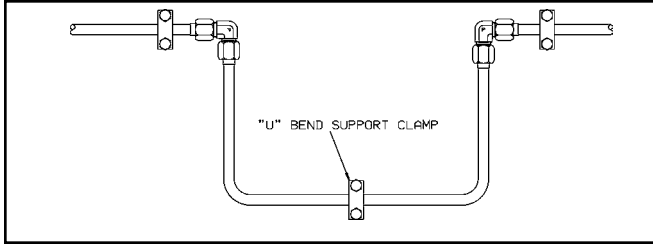

Fig. A22 — U-Bend Allowing Expansion and Contraction

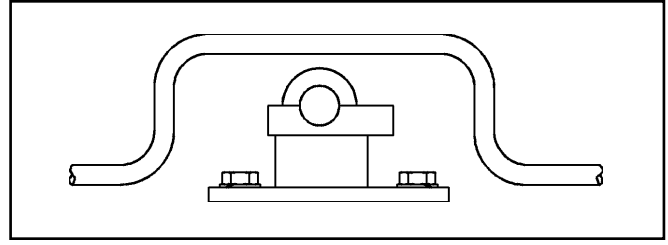

Fig. A25 — Incorrect

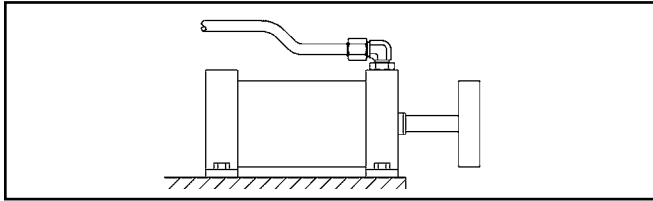

Fig. A23 — Bent Tube Allowing for Motion Under Load

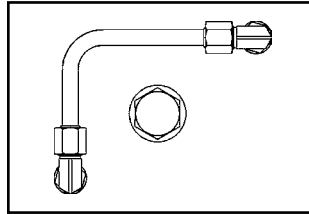

Fig. A26 — Correct

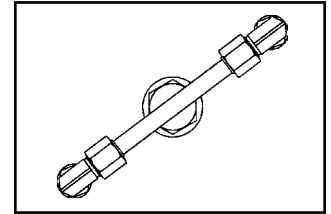

Fig. A27 — Incorrect

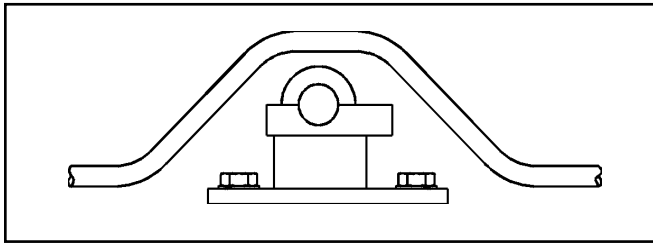

Fig. 24 — Correct

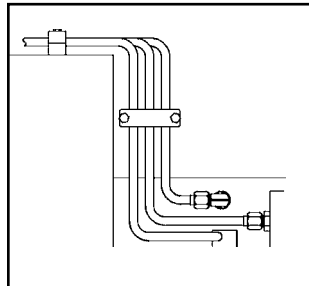

Fig. A28 — Correct

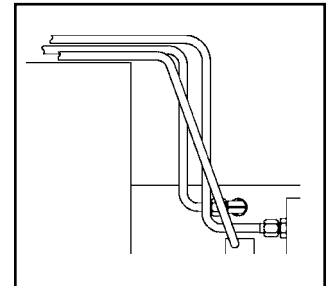

Fig. A29 — Incorrect

Thread Specifications

Dryseal Pipe Threads

All dryseal pipe threads are manufactured in accordance with the American National Standards Institute (ANSI) B1.20.3 specification and designed to seal pressure tight joints. The threads may incorporate the NPTF (National Standard Pipe Taper Fuel and Oil), PTF-SAE Short, PTF-SPL Short or PTF-SPL Extra Short form. Dryseal threads are used on brass products found within this catalog. Use of a thread sealant is recommended.

Non-Dryseal Pipe Threads

All non-dryseal pipe threads are manufactured in accordance with the American National Standards Institute (ANSI) B1.20.1 specification. These tapered pipe threads are used on our carbon and stainless steel products. Use of a thread sealant is recommended.

Nickel Plating

Nickel Plating is optional on standard product. Specifications for plating are not considered when standard product is manufactured. Since plating will alter thread pitch diameters, all plated threads should be qualified by functional fit with mating parts and not by standard thread gauging. Consult factory on plated product that will be qualified by standard thread gauging. These should be ordered as non-standards so product can be machined to pre-plated specifications.

Nickel plating provides a corrosion resistant coating which is desirable in many applications. Electrolytic nickel plating is the standard plating supplied unless otherwise specified. This will provide a uniform coverage of external surfaces; however, internal surfaces may be uncoated.

Unified Threads

All threads in the columns headed "Straight Thread" found within this catalog are manufactured in accordance with the American National Standards Institute (ANSI) B1.1 specification.

British Standard Pipe Threads BSPT and BSPP

Pressure Tight

The British pipe threaded products found within this catalog intended for use where pressure tight joints are made on the threads are manufactured in accordance with British Standard (BS) 21 and International Standards Organization (ISO) 7-1. The threads are designated as follows:

- Rp: Internal parallel
- Rc: Internal taper
- Rs: Special external parallel
- R: External taper

Use of a thread sealant is recommended with the R series thread. An elastomeric peripheral seal should be used with the Rs thread.

Non-Pressure Tight

All British Standard parallel pipe threads manufactured in this catalog according to BS2779 and ISO 228-1 are intended for use where pressure tight joints are not made on the threads. An elastomeric peripheral seal should be used. These threads are designated as follows:

- G: Internal Thread
- GA, External thread, tight tolerance classification
- GB, External thread, general purpose and assumed if no classification designation is given

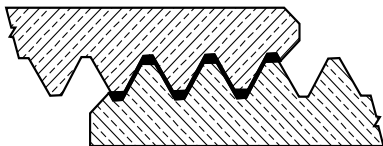

Dryseal Pipe Thread

Metal to metal contact. Crests of thread are crushed by the roots when wrench-tightened to form seal.

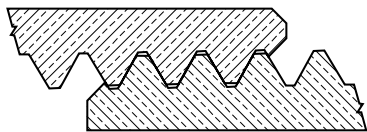

Non-Dryseal Pipe Thread

Flanks are in contact with possible clearance between the roots and crests. Will not prevent spiral leakage

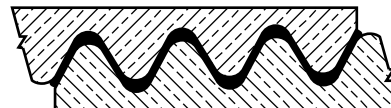

BS21 British Standard Pipe Thread for Pressure Tight Joints

Metal to metal contact provides seal as tapered thread is wrench-tightened.

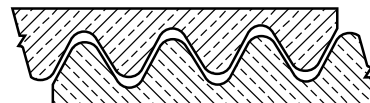

BS2779 British Standard Pipe Thread for Non-Pressure Tight Joints

Thread tolerances allow for possible clearance between threads. Will not prevent leakage paths.

Pipe Thread Assembly

The two British Standard pipe thread forms used for Parker's standard product are manufactured in a tighter tolerance range than required by the standards in order to facilitate the assembly and mating of fittings produced by the two different standards. In general, BS21 threads do not necessarily mate with BS2779 threads at tolerance overlap conditions, but fittings located within this catalog can be assembled as follows:

External Thread	Mating Internal Thread
G-BS2779 (parallel)	G-BS2779 (parallel) Rp-BS21* (parallel)
Rs-BS21 (parallel)	Rp-BS21 (parallel) G-BS2779 (parallel)
R-BS21 (taper)	Rp-BS21 (parallel) Rc-BS21 (taper) G-BS2779 (parallel)

*This thread must be manufactured within a reduced tolerance range to always assemble with the G series external thread.

British Standard ISO Metric Screw Threads

They are commonly used in miniature pneumatic applications because of the availability of small thread diameters and are also used extensively in the automotive industry. There are two forms of sealing on metric screw threads.

- O-ring sealing into a profiled port in accordance with ISO 6149.
- Peripheral sealing with a copper or bonded washer in accordance with ISO 261 and 262.

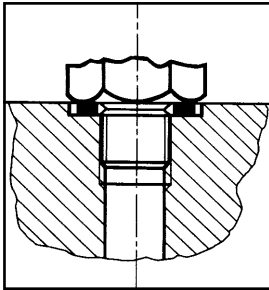

Peripheral sealing of parallel threads

Pressure-tight joints of screwed connections with parallel threads are achieved by placing a seal between the two machined faces

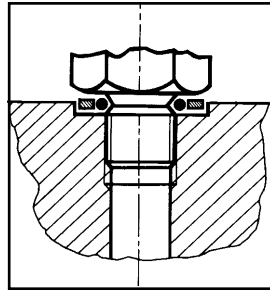

Flat seals

Washers and rings are manufactured in many different materials including copper, aluminium, fiber, plastics, etc.

The tightening torque at assembly must be carefully selected so as to avoid compressing the seal to the point of extrusion. As a general rule, the fitting should be tightened with an additional 1/4 wrench turn from the fingertight position.

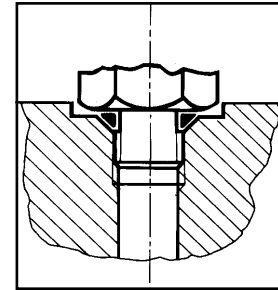

O-rings

Depending upon the configuration of the female port or male thread, O-Ring seals are fitted with or without back-up washers, and can be fully retained in a captive seal.

Flaring Instructions

In order to properly flare copping tubing for use with Parker 45° Flared Fittings and Inverted Flared Fittings, the following procedures and specifications should be met in preparation and make-up of flares.

1. Cut tube with tube cutter:

To minimize the burr and workhardening, use a light feed on the cutting wheel and make several revolutions.

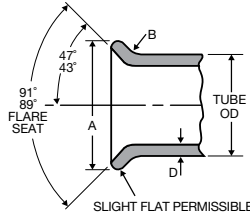

2. Ream the tubing:

Cutting with a tube cutter will always create a burr. The burr must be removed to obtain maximum sealing surface. Remove only the burr, do not remove material from the original wall thickness. Also clean the tube end thoroughly to remove burrs.

3. Flare tubing: Flare with a compression or generating type flaring tool. Follow tool manufacturer's instructions for: (a) positioning the tube in tool and (b) for the correct number of turns on the feed handle.

4. Inspect tubing: The flare cone should be checked for a smooth surface on the i.D. Of the cone and measure with micrometer over largest o.D. For proper size. (See dimensions below for flare size for each tubing size.)

NOMINAL TUBE	A SINGLE FLARE DIAMETER		B SINGLE FLARE RADIUS	D SINGLE FLARE WALL THICKNESS
	MAX. IN	MIN. IN	+/- 0.01 IN	MAX. IN
1/8	.181	.171	.02	.035
3/16	.249	.239	.02	.035
1/4	.325	.315	.02	.049
5/16	.404	.388	.02	.049
3/8	.487	.471	.02	.065
7/16	.561	.545	.02	.065
1/2	.623	.607	.02	.083
9/16	.676	.660	.02	.083
5/8	.748	.732	.02	.095
3/4	.916	.900	.02	.109
7/8	1.041	1.025	.02	.109
1	1.157	1.141	.02	.120

Thread Designations and Standards for Threads Used in Fluid Connectors

	ABBREVIATION	DESCRIPTION	APPLICABLE STD.
STRAIGHT PIPE	NPSC	AMERICAN STANDARD STRAIGHT PIPE THREADS IN PIPE COUPLINGS	ANSI B1.20.1 FED-STD-H28/7
	NPSF	DRYSEAL AMERICAN STANDARD FUEL INTERNAL STRAIGHT PIPE THREADS (GENERALLY SED IN SOFT OR DUCTILE MATERIALS TO MATE WITH NPTF EXTERNAL TAPER THREADS)	SAE J476 ANSI B1.20.3 FED-STD-H28/8
	NPSI	DRYSEAL AMERICAN INTERMEDIATE INTERNAL STRAIGHT PIPE THREADS (FOR BRITTLE OR HARD MATERIALS; INTENDED TO MATE WITH PTF-SAE SHORT EXTERNAL TAPER THREADS)	SAE J476 ANSI B1.20.3 FED-STD-H28/8
	NPSM	AMERICAN STANDARD STRAIGHT PIPE THREADS FOR FREE-FITTING MECHANICAL JOINTS FOR FIXTURES (THESE THREADS FIT FREELY OVER NPTF THREADS. THEY ARE USED IN SWIVEL NUTS OF 07 ADAPTERS)	ANSI B1.20.1 FED-STD-H28/7
TAPER PIPE	ANPT	AERONAUTICAL NATIONAL TAPER PIPE THREADS (SIMILAR TO NPT WITH VARIOUS ADDITIONAL REQUIREMENTS IN GAGING)	MIL-P-7105
	NPT	AMERICAN STANDARD TAPER PIPE THREADS FOR GENERAL USE	ANSI B1.20.1 FED-STD-H28/7
	NPTF	DRYSEAL AMERICAN STANDARD TAPER PIPE THREADS (USED IN ALL OF OUR STEEL AND BRASS FITTINGS)	SAE J476 ANSI B1.20.3 FED-STD-H28/8
	PTF - SAE SHORT	DRYSEAL SAE SHORT TAPER PIPE THREADS (MAINLY USED IN LOW PRESSURE PNEUMATIC AND FUEL APPLICATIONS)	SAE J476 ANSI B1.20.3 FED-STD-H28/8
	PTF - SPL SHORT ¹	DRYSEAL SPECIAL SHORT TAPER PIPE THREADS	ANSI B1.20.3
	PTF - SPL EXTRA SHORT ¹	DRYSEAL SPECIAL EXTRA SHORT TAPER PIPE THREADS	ANSI B1.20.3

Continued next page

	ABBREVIATION	DESCRIPTION	APPLICABLE STD.
UNIFIED THREADS	UN	UNIFIED CONSTANT PITCH THREADS (STANDARD SERIES: 4, 6, 8, 12, 16, 20, 28, 32)	ANSI B1.1 ED-STD-H28/2
	UNC	UNIFIED COARSE THREADS	ANSI B1.1 FED-STD-H28/2
	UNEF	UNIFIED EXTRA FINE THREADS	ANSI B1.1 FED-STD-H28/2
	UNF	UNIFIED FINE THREADS	ANSI B1.1 FED-STD-H28/2
	UNS	UNIFIED SPECIAL PITCH THREADS	ANSI B1.1 FED-STD-H28/3
	UNJ	UNIFIED CONTROLLED ROOT RADIUS THREADS	ANSI B1.15 FED-STD-H28/4
METRIC THREADS	M	METRIC SCREW THREADS — M PROFILE	ISO 261 ANSI B1.13M FED-STD-H28/21
	M — KEG	METRIC TAPER THREADS (MAINLY USED IN GERMANY)	DIN 158
BRITISH STANDARD	R (BSPT)	BRITISH STANDARD TAPER PIPE THREADS, EXTERNAL	BS 21 ISO 7/1
	RC (BSPT)	BRITISH STANDARD TAPER PIPE THREADS, INTERNAL	BS 21 ISO 7/1
	RP OR G (BSPP)	BRITISH STANDARD PIPE (PARALLEL) THREADS	BS 2779 ISO 228/1
JAPANESE STANDARD	PF ²	JIS PARALLEL PIPE THREADS	JIS B202 ISO 228/1
	PT ²	JIS TAPER PIPE THREADS	JIS B203 ISO 7/1
	PS	JIS PARALLEL INTERNAL PIPE THREADS (TO MATE WITH PT THREADS)	JIS B203

Table A48 — Thread Designations and Standards for Threads Used in Fluid Connectors

- Used in some pneumatic components where shortened thread depth is required because of lack of enough material due to component size limitations.
- PF and PT threads are functionally interchangeable with BSPP and BSPT threads, respectively. These are old designations. They are being replaced with G (for PF) and R and Rc (for PT) as documents are revised.

Straight Thread Size Comparison Chart

	TUBE O.D.										
	1/8	3/16	1/4	5/16	3/8	7/16	1/2	5/8	3/4	7/8	1
SAE 45° FLARED	5/16 -24	3/8 -24	7/16 -20	1/2 -20	5/8 -18	11/16 -16	3/4 -16	7/8 -14	1-1/16 -14	1-1/4 -12	-
INVERTED FLARED	5/16 -28	3/8 -24	7/16 -24	1/2 -20	5/8 -18	11/16 -18	3/4 -18	7/8 -18	1-1/16 -16	1-3/16 -16	-
AIR BRAKE/NTA	-	-	7/16 -24	-	17/32 -24	-	11/16 -20	13/16 -18	1 -18	-	1-1/4 -16
STANDARD, COMPRESSION / COMPRESS-ALIGN	5/16 -24	3/8 -24	7/16 -24	1/2 -24	9/16 -24	5/8 -24	11/16 -20	13/16 -18	1 -18	1-1/8 -18	1-1/4 -18
POLY-TITE			3/8 -24	7/16 -24	1/2 -24	-	11/16 -20	-	-	-	-
VIBRA-LOK	3/8 -24	-	1/2 -24	9/16 -24	5/8 -24	-	13/16 -18	1 -18	1-1/8 -18	-	-
V510 BALL VALVES	-	-	7/16 -20	-	9/16 -18	-	3/4 -16	7/8 -14	1-1/16 -12	-	1-5/16 -12
HI-DUTY FLARELESS TUBE FITTINGS	5/16 -24	3/8 -24	7/16 -20	1/2 -20	9/16 -20	-	11/16 -16	7/8 -18	-	-	-

S.A.E. Part Index

<u>PART NO.</u>	<u>PAGE</u>	<u>PART NO.</u>	<u>PAGE</u>	<u>PART NO.</u>	<u>PAGE</u>	<u>PART NO.</u>	<u>PAGE</u>
SAE 010101	H8	SAE 010202.....	H10	SAE 060101 BA.....	G8	SAE 100202 BA.....	F9
SAE 010102.....	H9	SAE 010203.....	H11	SAE 060102 BA.....	G9	SAE 100203 BA.....	F9
SAE 010103.....	H9	SAE 010302	H11	SAE 060103 BA.....	G9	SAE 100302 BA.....	F9
SAE 010104.....	H8	SAE 010401.....	H10	SAE 060110.....	G8	SAE 100401 BA.....	F8
SAE 010105.....	H12	SAE 010424.....	H11	SAE 060111	G8	SAE 100424 BA.....	F9
SAE 010106.....	H12	SAE 010425.....	H10	SAE 060115.....	G8	SAE 100425 BA.....	F9
SAE 010107.....	H12	SAE 010501.....	H10	SAE 060201 BA.....	G10	SAE 120101 BA.....	F13
SAE 010108.....	H7	SAE 040101.....	H14	SAE 060202 BA	G10	SAE 120102 BA.....	F13
SAE 010109.....	H12	SAE 040102	H14	SAE 060203 BA	G11	SAE 120103 BA.....	F13
SAE 010110	H8	SAE 040103	H14	SAE 060401 BA	G10	SAE 120111	F13
SAE 010111	H8	SAE 040110.....	H14	SAE 060424 BA.....	G11	SAE 120115	F13
SAE 010112	H12	SAE 040202	H15	SAE 060425 BA	G11	SAE 120201 BA.....	F13
SAE 010113	H7	SAE 040203	H15	SAE 100101 BA	F7	SAE 120202 BA.....	F14
SAE 010114	H7	SAE 040302	H15	SAE 100102 BA	F8	SAE 120203 BA.....	F14
SAE 010165.....	H7	SAE 040401	H14	SAE 100103 BA.....	F8	SAE 120302 BA.....	F14
SAE 010166.....	H7	SAE 040424	H15	SAE 100110	F7	SAE 120401 BA.....	F13
SAE 010167.....	H7	SAE 040425	H15	SAE 100115	F7	SAE 120424 BA.....	F14
SAE 010201.....	H11	SAE 040427	H15	SAE 100201 BA.....	F8	SAE 120425 BA.....	F14

SAE Standards

(Current)

- J246:** Spherical and Flanged Sleeve (Compression) Tube Fittings
Tubing: Copper and J844 Nylon
Fittings: NTA and Air Brake
- J476:** Dryseal Pipe Threads
- J512:** Automotive Tube Fittings
Tubing: Copper and Nylon
Fittings: 45° Flare, Inverted Flare, Compression
- J513:** Refrigeration Tube Fittings
Tubing: Annealed Copper
Fittings: 45° Flare
- J530:** Automotive Pipe Fittings
Fittings: Pipe
- J531:** Automotive Pipe, Filler and Drain Plugs
Fittings: Pipe Plugs
- J844:** Nonmetallic Air Brake System Tubing
Tubing: Non-reinforced Type A, reinforced Type B
- J1131:** Performance Requirements for SAE J844 Nonmetallic Tubing and Fitting Assemblies Used in Automotive Air Brake Systems
Tubing: J844 Nylon
Fittings: NTA and Prestomatic
- J1615:** Thread Sealants
- J2494:** Brass Body Push-to-Connect Fittings
Tubing: J844 Nylon
Fittings: Prestomatic

U.L. Listed Fittings

Many of the Fluid System Connectors Division's fittings have been listed by the Underwriter's Laboratory. The listings fall under 1 of 3 categories, depending upon application. Underwriter's requires that the smallest unit package carry the U.L. symbol and each carton be printed in accordance with the specification of each category.

List of U.L. Fittings

FITTINGS, FLAMMABLE LIQUID			
1F	62C	168CA	252IFHD
2GF	62CA	169C	256IF
3GF	62CABH	169CA	259IFHD
14FL	62CBH	170C	264C
14FSV	66C	170CA	264CA
14FSX	66CA	171C	265C
41FL	68C	171CA	265CA
41FS	68CA	172C	269C
41FX	144F	172CA	269CA
41IF	145F	176C	270C
41IFS	147F	176CA	270CA
42F	149F	177C	639C
42IFHD	150F	177CA	639CA
46F	151F	244F	639F
46IFHD	155F	244IFHD	640F
48F	159F	245IFHD	660FHD
48IFHD	164C	249F	661FHD
60C	164CA	249IF	664FHD
61C	165C	249IFHD	
61CA	165CA	250IFHD	
61CL	168C	251IFHD	

FITTINGS, FUEL EQUIPMENT, MARINE			
2GF	144F	155F	664FHD
3GF	145F	159F	
14FL	147F	639F	
42F	149F	640F	
46F	150F	660FHD	
48F	151F	661FHD	

SHUT-OFF VALVES, FLAMMABLE LIQUIDS, LP GAS AND COMPRESS GAS		
XV520P-4	XV520P-20	XV500P-20
XV520P-6	XV520P-24	XV500P-24
XV520P-8	XV520P-32	XV500P-32
XV520P-12	XV520P-40	
XV520P-16	XV520P-48	

Flow Curves

87 PSI (5.9 bar) ■ Return Direction ■ Controlled Direction N = Number of Turns F = Flow in SCFM

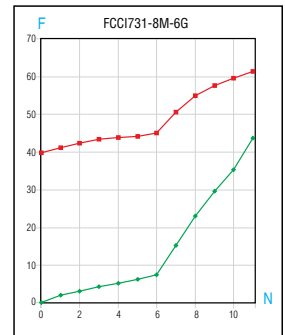
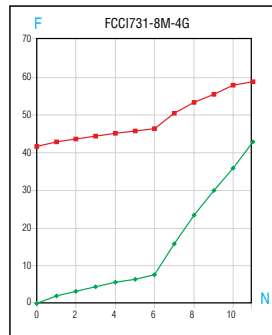
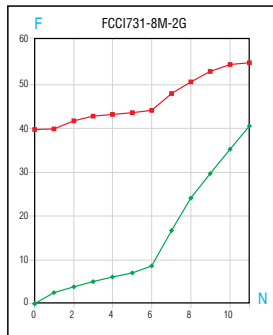
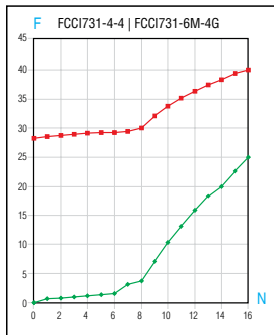
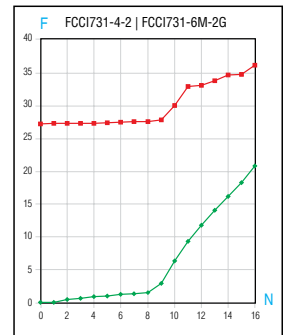
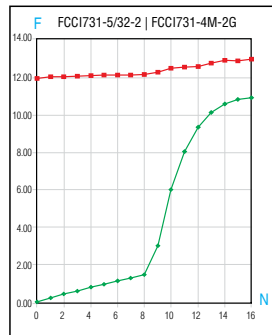
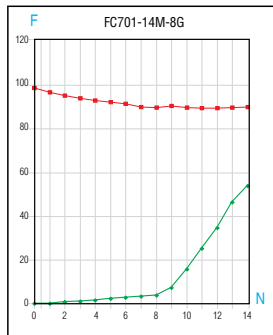
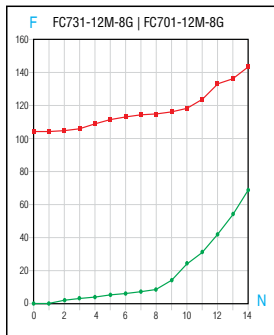
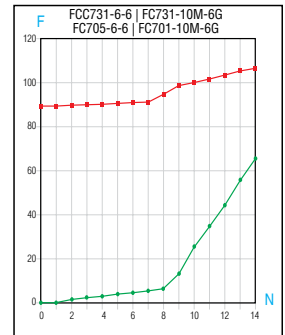
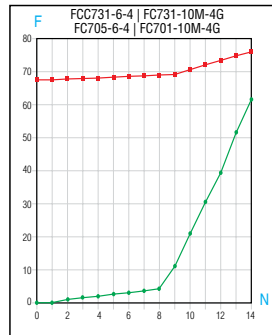
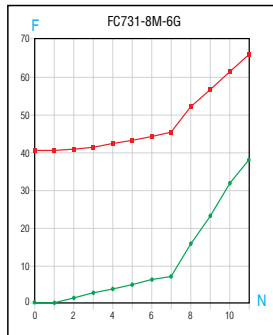
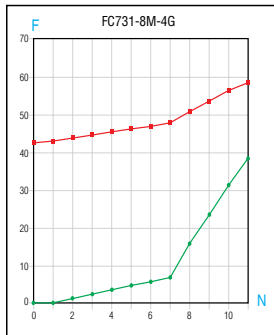
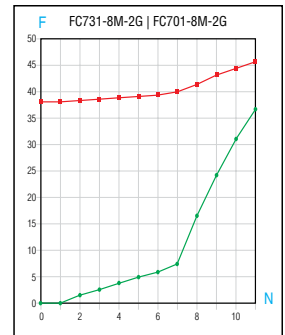
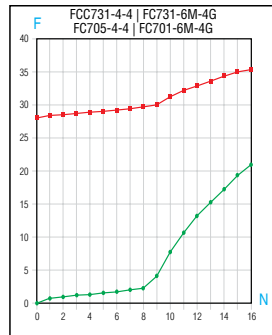
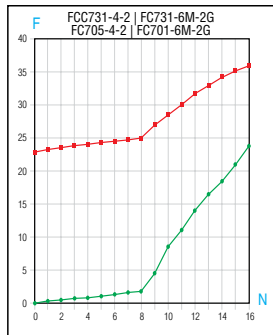
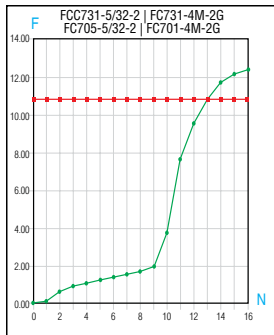

87 PSI (5.9 bar) ■ Return Direction ■ Controlled Direction N = Number of Turns F = Flow in SCFM

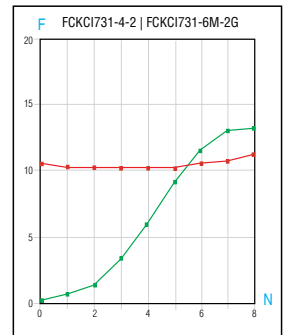
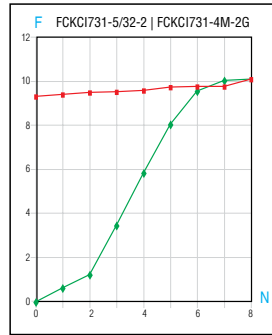
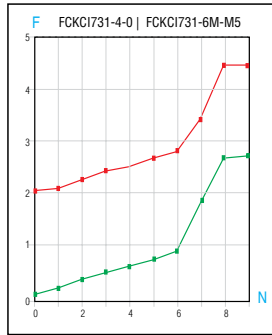
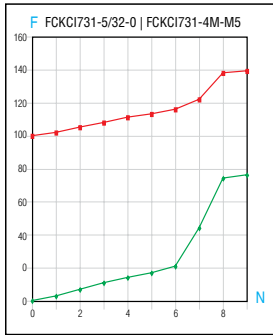
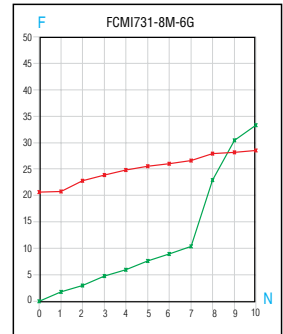
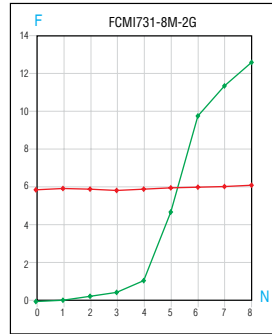
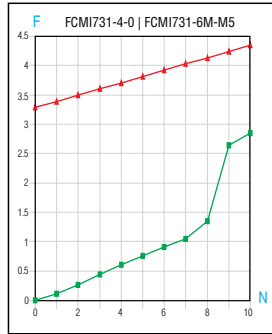
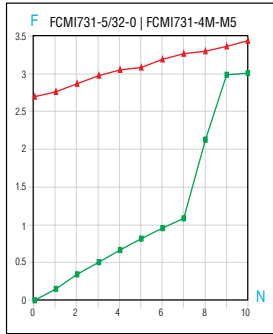
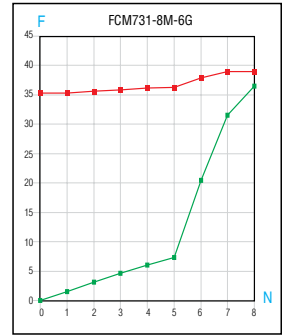
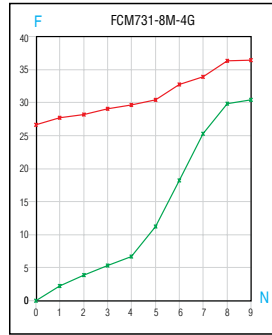
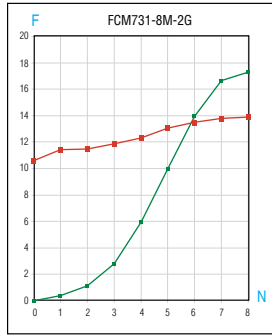
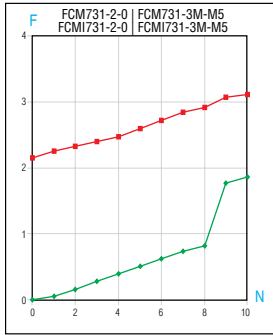
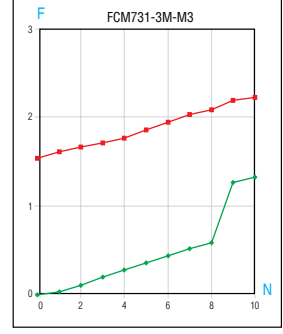
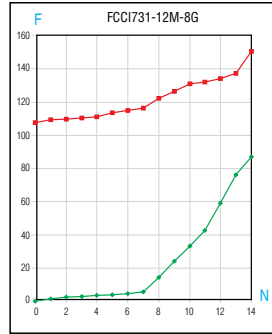
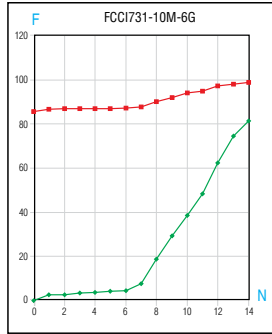
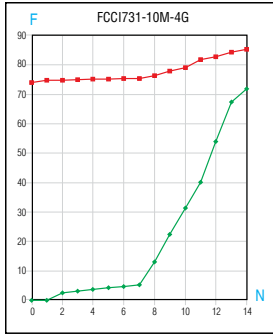

87 PSI (5.9 bar) ■ Return Direction ■ Controlled Direction N = Number of Turns F = Flow in SCFM

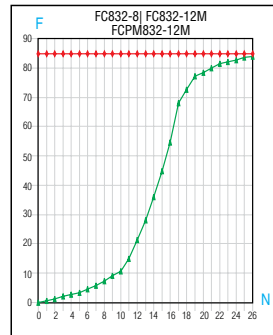
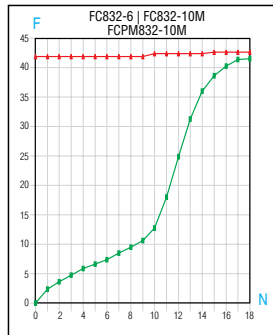
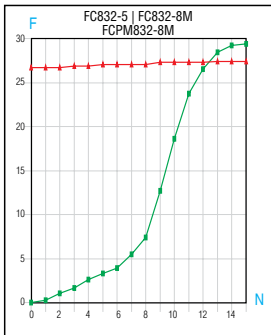
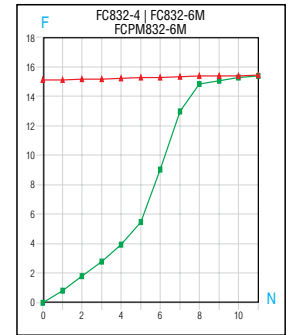
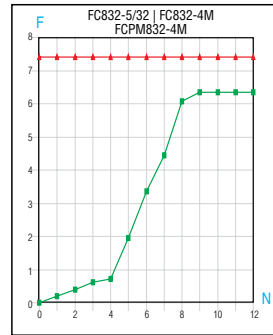
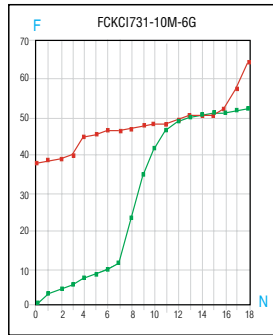
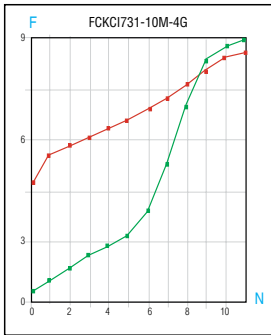
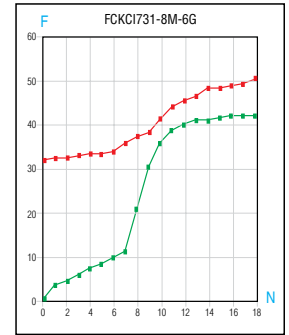
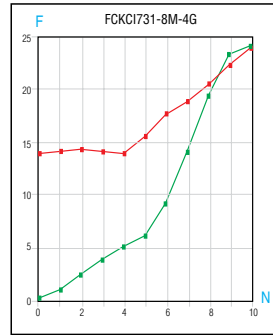
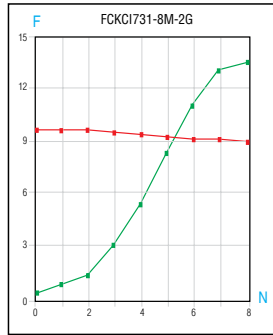
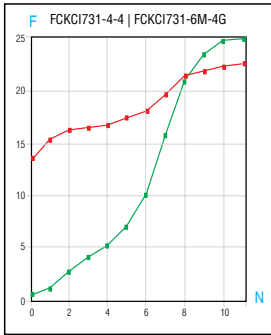

87 PSI (5.9 bar) ■ Return Direction ■ Controlled Direction N = Number of Turns F = Flow in SCFM

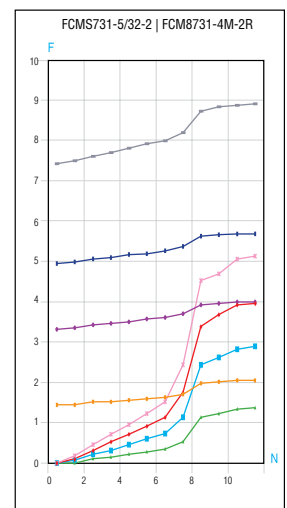
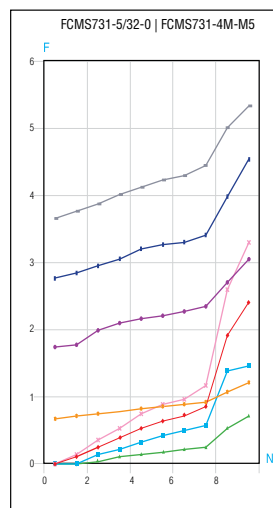
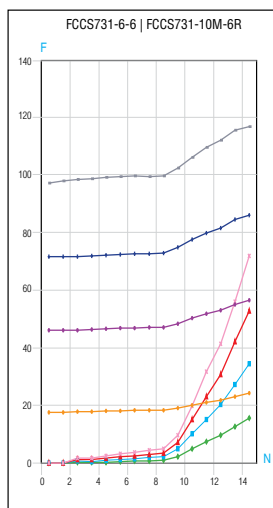
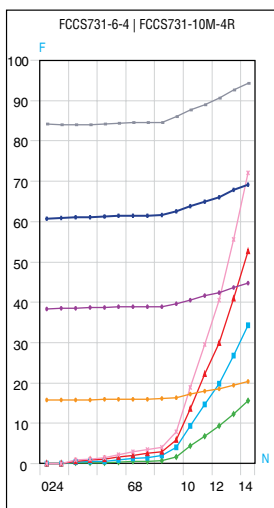
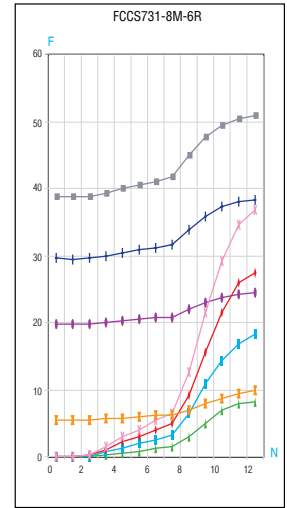
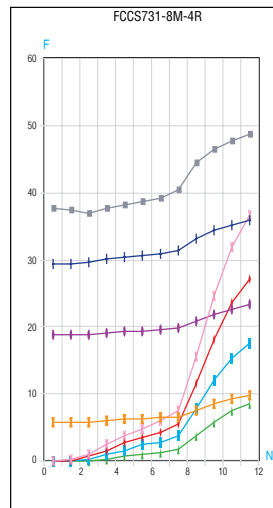
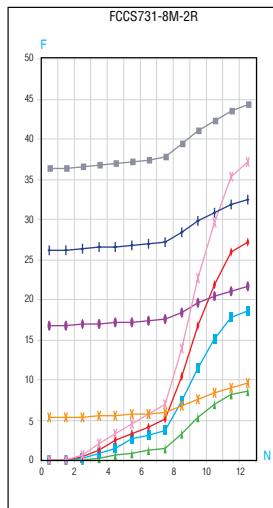
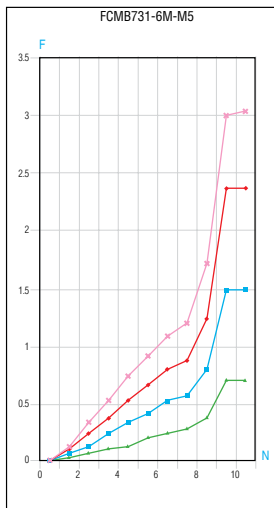
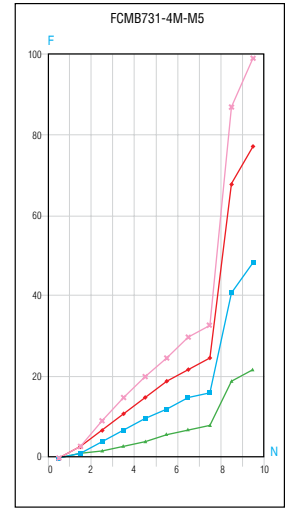
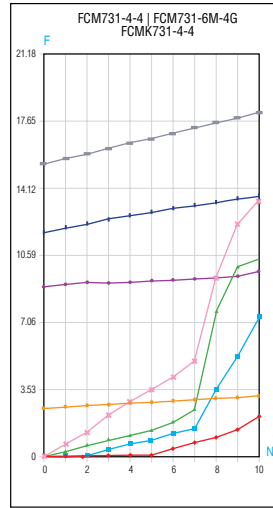
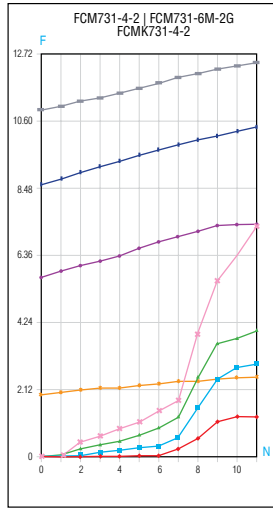
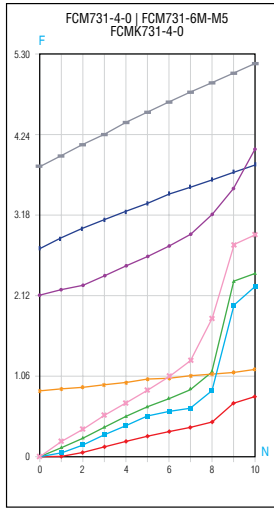

— Controlled Direction – 14.5 PSI (0.9 bar) — Controlled Direction – 43.5 PSI (2.9 bar)
— Controlled Direction – 72.5 PSI (4.9 bar) — Return Direction – 43.5 PSI (2.9 bar)
— Return Direction – 14.5 PSI (0.9 bar) — Return Direction – 101.5 PSI (6.9 bar)
— Return Direction – 72.5 PSI (4.9 bar)



87 PSI (5.9 bar) ■ Return Direction ■ Controlled Direction N = Number of Turns F = Flow in SCFM

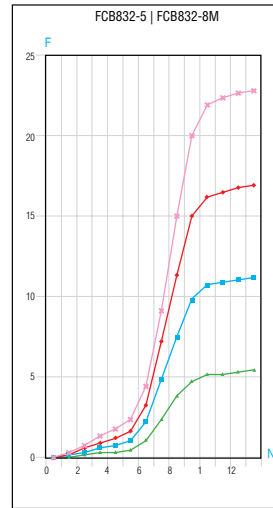
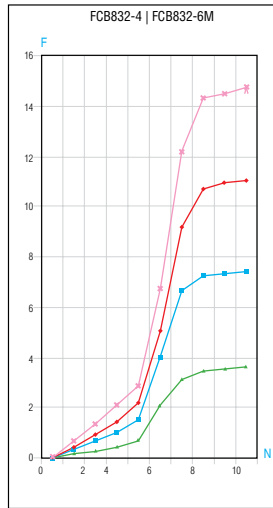
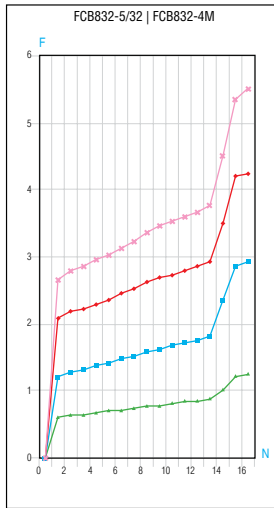
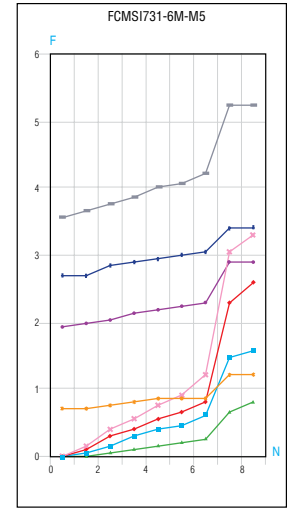
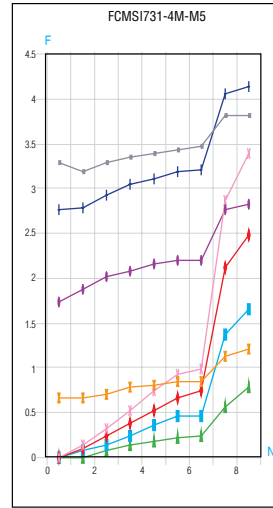
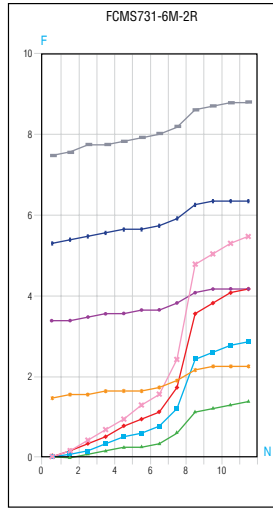
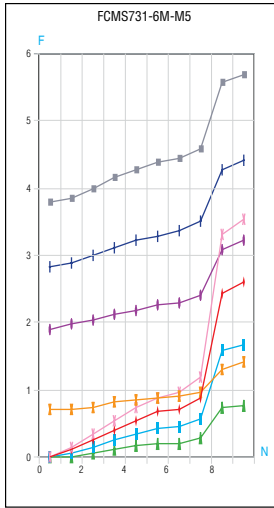

—■ Controlled Direction – 14.5 PSI (0.9 bar)	—■ Controlled Direction – 43.5 PSI (2.9 bar)
—■ Controlled Direction – 72.5 PSI (4.9 bar)	—x Controlled Direction – 101.5 PSI (6.9 bar)
—■ Return Direction – 14.5 PSI (0.9 bar)	—■ Return Direction – 43.5 PSI (2.9 bar)
—■ Return Direction – 72.5 PSI (4.9 bar)	—■ Return Direction – 101.5 PSI (6.9 bar)



Flare and Thread Profiles

SAE (JIC) 37° Flare Nose Sizes

Actual Size

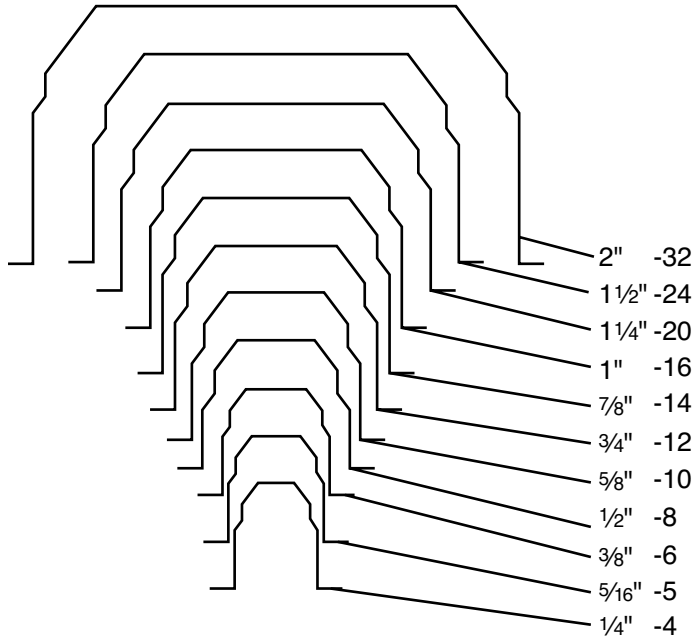

SAE 45° Flare Nose Sizes

Actual Size

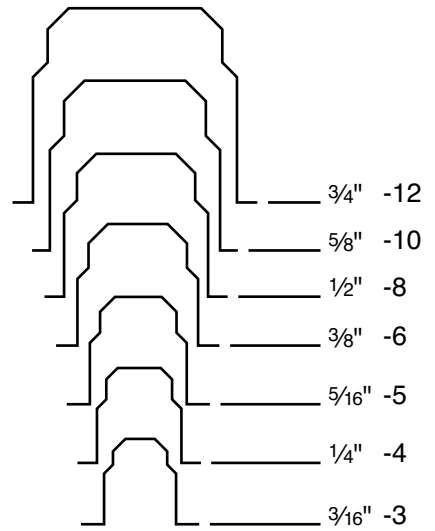

Male Pipe Thread Sizes

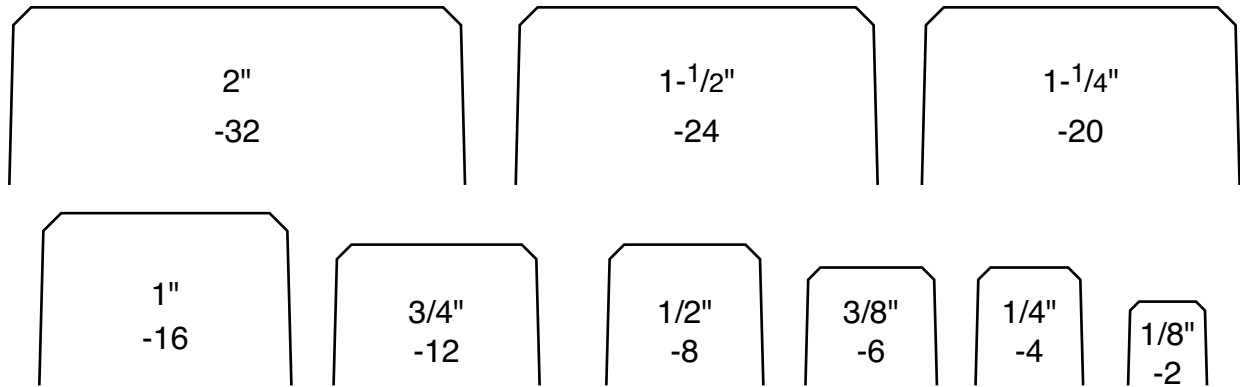

Actual Outside Diameters of Tubing

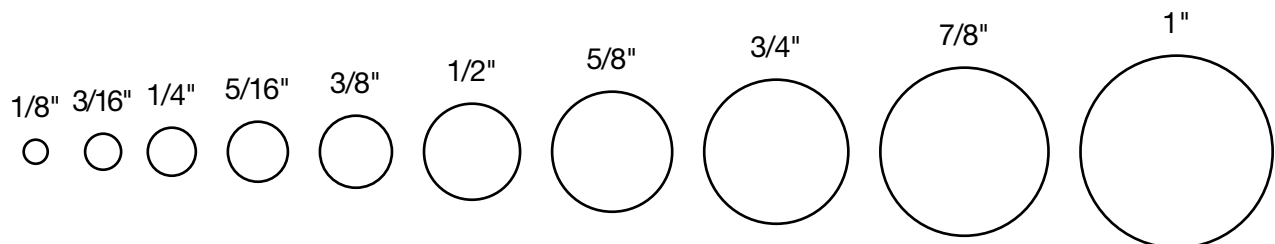

Pressure Conversions

KILOPASCALS (KPA)	MEGAPASCALS (MPA)	BAR (bar)	KILOGRAMS PER SQUARE CENTIMETER (KGF/CM2)	POUNDS PER SQUARE INCH (PSI)
100	1.0	1	1.02	14.50
200	.2	2	2.04	29.00
300	.3	3	3.06	43.50
400	.4	4	4.08	58.00
500	.5	5	5.10	72.50
600	.6	6	6.12	87.00
700	.7	7	7.14	101.50
800	.8	8	8.16	116.00
900	.9	9	9.18	130.50
1000	1.0	10	10.20	145.00
2000	2.0	20	20.40	290.10
3000	3.0	30	30.60	435.10
4000	4.0	40	40.80	580.20
5000	5.0	50	51.00	725.20
6000	6.0	60	61.20	870.20
7000	7.0	70	71.40	1015.30
8000	8.0	80	81.60	1160.30
9000	9.0	90	91.80	1305.30
10000	10.0	100	102.00	1450.00
20000	20.0	200	204.00	2901.00
30000	30.0	300	306.00	4351.00
40000	40.0	400	408.00	5802.00
50000	50.0	500	510.00	7252.00
60000	60.0	600	612.00	8702.00
70000	70.0	700	714.00	10153.00
80000	80.0	800	816.00	11603.00
90000	90.0	900	918.00	13053.00
100000	100.0	1000	1020.00	14504.00
200000	100.0	2000	2040.00	29008.00
300000	300.0	3000	3060.00	43511.00

POUNDS PER SQUARE INCH (PSI)	KILOPASCALS (KPA)	MEGAPASCALS (MPA)	BAR (bar)	KILOGRAMS PER SQUARE CENTIMETER (KGF/CM2)
10	68.90	.07	.70	.70
20	137.90	.14	1.41	1.41
30	206.80	.21	2.10	2.11
40	275.80	.28	2.80	2.81
50	344.70	.34	3.40	3.52
60	413.70	.41	4.10	4.22
70	482.60	.48	4.80	4.92
80	551.60	.55	5.50	5.63
90	620.50	.62	6.20	6.33
100	689.00	.70	6.90	7.00
200	1379.00	1.40	13.80	14.10
300	2068.00	2.10	20.70	21.10
400	2758.00	2.80	27.60	28.10
500	3447.00	3.40	34.50	35.20
600	4137.00	4.10	41.40	42.20
700	4826.00	4.80	48.30	49.20
800	5516.00	5.50	55.20	56.30
900	6205.00	6.20	62.10	63.30
1000	6895.00	6.90	68.90	70.30
2000	13790.00	13.80	137.90	140.70
3000	20684.00	20.70	206.80	211.00
4000	27579.00	27.60	275.80	281.30
5000	34474.00	34.50	344.70	351.60
6000	41369.00	41.40	413.70	421.90
7000	48263.00	48.30	482.60	492.30
8000	55158.00	55.20	551.60	562.60
9000	62053.00	62.10	620.50	632.90
10000	68948.00	68.90	689.00	703.00
20000	137895.00	137.90	1379.00	1406.00
30000	206843.00	206.80	2068.00	2110.00
40000	275790.00	275.80	2758.00	2813.00

Tube Insertion Depths

This engineering standard covers the tube insertion depths and minimum depths to pass thru the o-ring. The depths are used for conveying information to customers and are meant to be used only as a guideline.

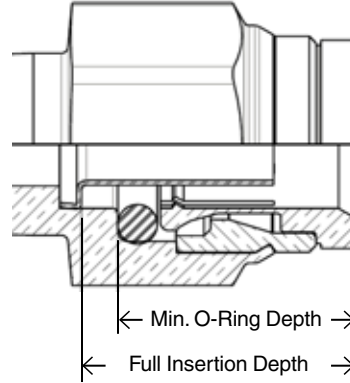
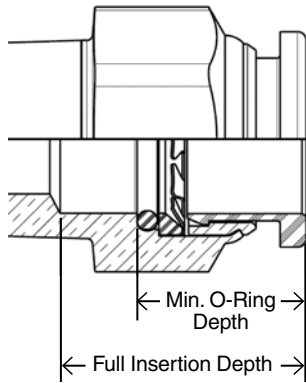

Brass Prestolok Plus (PLP)

TUBE SIZE	FULL INSERTION DEPTH (IN.)	MINIMUM O-RING DEPTH (IN.)
1/8"	.64	.48
5/32"	.64	.48
3/16"	.67	.48
1/4"	.67	.49
5/16"	.77	.51
3/8"	.78	.51
1/2"	.85	.58

LF3000 (Composite PLP) & LIQUIfit

TUBE SIZE	FULL INSERTION DEPTH (IN.)	MINIMUM O-RING DEPTH (IN.)
1/8"	.46	.38
3/16"	.65	.56
1/4"	.58	.44
3/8"	.81	.62
1/2"	1.09	.84
4MM	.51	.39
6MM	.58	.45
8MM	.73	.55
10MM	.81	.62
12MM	.97	.73
14MM	1.08	.83
16MM	1.15	.89

LF3600 (PLM)

TUBE SIZE	FULL INSERTION DEPTH (IN.)	MINIMUM O-RING DEPTH (IN.)
1/4"	.66	.55
3/8"	.88	.73
1/2"	.89	.74
4MM	.57	.49
6MM	.68	.57
8MM	.71	.62
10MM	.90	.75
12MM	.96	.78
14MM	1.00	.82

Carstick

TUBE SIZE	FULL INSERTION DEPTH (IN.)	MINIMUM O-RING DEPTH (IN.)
1/8"	.46	.38
1/4"	.75	.55
3/8"	.86	.68
1/2"	1.16	.92
4MM	.49	.41
6MM	.58	.49
8MM	.71	.60
10MM	.85	.67
12MM	1.00	.79

Composite PTC

TUBE SIZE	FULL INSERTION DEPTH (IN.)	MINIMUM O-RING DEPTH (IN.)
1/4"	.58	.47
3/8"	.70	.53
1/2"	.80	.61
5/8"	.99	.72
3/4"	1.04	.83

Metric Prestomatic

TUBE SIZE	FULL INSERTION DEPTH (IN.)	MINIMUM O-RING DEPTH (IN.)
6MM	.78	
8MM	.80	
10MM	.91	
12MM	.91	
16MM	.89	

PMTCE

TUBE SIZE	FULL INSERTION DEPTH (IN.)	MINIMUM O-RING DEPTH (IN.)
1/4"	.65	.54
3/8"	.81	.72
1/2"	.94	.72
5/8"	1.00	.75
3/4"	1.00	.75

LF3800 (PLS)

TUBE SIZE	FULL INSERTION DEPTH (IN.)	MINIMUM O-RING DEPTH (IN.)
1/4"	.69	.58
3/16"	.57	.49
3/8"	.90	.75
1/2"	.93	.78
4MM	.57	.49
6MM	.67	.56
8MM	.74	.65
10MM	.91	.76
12MM	.96	.79

Brass PTC

TUBE SIZE	FULL INSERTION DEPTH (IN.)	MINIMUM O-RING DEPTH (IN.)
5/32"	.64	.44
3/16"	.62	.44
1/4"	.59	.49
3/8"	.78	.56
1/2"	.85	.63
5/8"	1.02	.80
3/4"	1.03	.82

Prestomatic

TUBE SIZE	FULL INSERTION DEPTH (IN.)	MINIMUM O-RING DEPTH (IN.)
1/4"	.63	.54
3/8"	.81	.72
1/2"	.94	.72
5/8"	1.12	.75
3/4"	1.12	.92

TrueSeal – Acetal & Kynar

TUBE SIZE	FULL INSERTION DEPTH (IN.)	MINIMUM O-RING DEPTH (IN.)
1/4"	.71	.52
5/16"	.80	.55
3/8"	.80	.55
1/2"	.90	.63

TrueSeal - PolyPropylene

TUBE SIZE	FULL INSERTION DEPTH (IN.)	MINIMUM O-RING DEPTH (IN.)
1/4"	.74	.55
3/8"	.83	.59
1/2"	.93	.66

English/Metric Conversions

Inches x 25.4 = Millimeters (mm)
 Inches x 2.54 = Centimeters (cm)
 Inches x .254 = Decimeters (dm)
 Feet x .3048 = Meters (m)
 Yards x .9144 = Meters (m)
 PSI x .0689 = Bars (bar)
 Bars x 100 = Kilopascals (kPa)
 PSI x .0069 = Megapascals (MPa)
 Pound Inches x .113 = Newton Meters (N•m)

Pound Feet x 1.356 = Newton Meters (N•m)
 Millimeters x .0394 = Inches
 Centimeters x .3937 = Inches
 Meters x 3.281 = Feet
 Meters x 1.0936 = Yards
 Bars x 14.5 = PSI Megapascals x 145 = PSI
 Newton Meters x 8.85 = Pound Inches
 Newton Meters x .737 = Pound Feet

Millimeters to Fractions to Decimals

MM	INCHES	
	FRACTION	DECIMAL
.3969	1/64	.0156
.7938	1/32	.0312
1.1906	3/64	.0468
1.5875	1/16	.0625
1.9844	5/64	.0781
2.3812	3/32	.0937
2.7781	7/64	.1093
3.1750	1/8	.1250
3.5719	9/64	.1406
3.9688	5/32	.1562
4.3656	11/64	.1718
4.7625	3/16	.1875
5.1594	13/64	.2031
5.5562	7/32	.2187
5.9531	15/64	.2343
6.3500	1/4	.2500

MM	INCHES	
	FRACTION	DECIMAL
6.7469	17/64	.2656
7.1438	9/32	.2812
7.5406	19/64	.2968
7.9375	5/16	.3125
8.3344	21/64	.3281
8.7312	11/32	.3437
9.1281	23/64	.3593
9.5250	3/8	.3750
9.9219	25/64	.3906
10.3188	13/32	.4062
10.7156	27/64	.4218
11.1125	7/16	.4375
11.5094	29/64	.4531
11.9062	15/32	.4687
12.3031	31/64	.4843
12.7000	1/2	.5000

MM	INCH	
	FRACTION	DECIMAL
13.0969	33/64	.5156
13.4938	17/32	.5312
13.8906	35/61	.5468
14.2875	9/16	.5625
14.6844	37/64	.5781
15.0812	19/32	.5937
14.4781	39/64	.6093
15.8750	5/8	.6250
16.2719	41/64	.6406
16.6688	21/32	.6562
17.0656	43/64	.6718
17.4625	11/16	.6875
17.8594	45/64	.7031
18.2562	23/32	.7187
18.6531	47/64	.7343
19.0500	3/4	.7500

MM	INCH	
	FRACTION	DECIMAL
19.4469	49/64	.7656
19.8438	25/32	.7812
20.2406	51/64	.7968
20.2375	13/16	.8125
21.0344	53/64	.8281
21.4312	27/32	.8437
21.8281	55/64	.8593
22.2250	7/8	.8750
22.6219	57/64	.8906
23.0188	29/32	.9062
23.4156	59/64	.9218
23.8125	15/16	.9375
24.2094	61/64	.9531
24.6062	31/32	.9687
25.0031	63/64	.9843
25.4000	1	1.0000

Assembly Guides

Push-to-Connect Fittings

- Prestolok PLP Metal
- Prestolok PLP Composite
- Prestolok PLM
- Prestolok PLS
- Oscillating Elbows
- LIQUIFit
- TrueSeal
- Flow Controls
- Prestomatic
- PTC
- Metric Prestomatic
- PMH
- Polypropylene Ball Valves

1. Cut tubing squarely – maximum of 15° angle allowable.
2. Check that port or mating part is clean and free of debris.
3. Mark tubing to appropriate tube insertion length. (see Tube Insertion Chart on page N22)
4. Insert tubing until it bottoms
5. Pull on tubing to verify it is fully inserted
6. To disassemble, simply press release button, hold against body and pull tubing out of fitting.



Transportation Compression Style NTA

1. Cut tubing squarely – maximum of 15° angle allowable.
2. Check that port or mating part is clean and free of debris.
3. Insert tubing until it bottoms on seat.
4. Tighten nut with wrench until one thread remains visible on the fitting body; (this will allow for a number of remakes) or, the nut should be screwed down finger tight, then wrench-tightened as indicated in the following table.

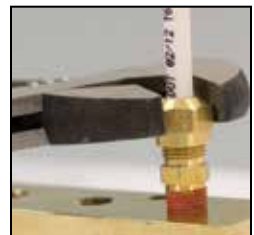

TUBE SIZE	ADDITIONAL NUMBER OF TURNS FROM HAND-TIGHT
3/16	2-1/2
1/4	3
3/8 & 1/2	4
5/8 & 3/4	3-1/2

Air Brake – AB Fittings

1. Cut tubing squarely and remove burrs
2. Slide nut and sleeve onto tubing.
3. Insert tubing into fitting until bottomed on seat. The nut should be screwed down finger tight, then wrench tightened as indicated in the chart



TUBE SIZE	TURNS REQUIRED TO SEAL FROM HAND-TIGHT
1/4, 3/8, 1/2	2
5/8, 3/4	3

Transmission Fittings

1. Cut tubing squarely and remove burrs
2. Insert tubing into fitting until bottomed
3. Tighten nut 1 1/2 turns from finger tight



Vibra-Lok

1. Cut the tubing squarely removing burrs
2. Slip nut and sleeve over tube
3. Bottom tubing into fitting and tighten nut until stop is reached. The elastic sleeve ordinarily will extrude slightly around the tube at the end of the nut. This extrusion further aids in isolating the tube from the nut.



For Higher Pressure applications

4. Consult pressure chart to determine if tubing should be belled
5. Slip nut and sleeve over tube. The sleeve should be positioned near end of tubing just behind the surface to be belled
6. Bell tubing with standard 45° flaring tool or 90° punch. The size of bell should be approximately that shown.



Air Brake Hose Ends

1. Slide nut onto hose
2. Slide sleeve onto hose with tapered edge toward fitting body
3. Bottom hose into fitting
4. Tighten nut until it contacts body hex



Note: When reassembling fitting, body and nut should be inspected. Only reuse if parts are in proper condition. Sleeves should never be Reused.

Recommended Size of Bell

TUBE O.D.	BELL DIA. C
1/8	.190-.160
3/16	.255-.225
1/4	.318-.288
5/16	.381-.351
3/8	.444-.414
1/2	.569-.539
5/8	.694-.664
3/4	.819-.789
7/8	.944-.914

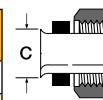

Tube Length Calculator

This table shows distance tube extends beyond face of Vibra-Lok fitting body on installation with bell on tubing and without bell on tubing.

O.D. OF TUBE	A WITH BELL	B WITHOUT BELL
1/8	3/16	3/16
3/16	3/16	7/32
1/4	3/16	1/4
5/16	3/16	1/4
3/8	3/16	1/4
1/2	3/16	11/32
5/8	3/16	TUBING SHOULD BE BELLED
3/4	3/16	
7/8	1/4	

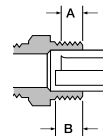

Compression

1. Slide nut then sleeve onto tubing. The thread end of the nut must face out.
2. Insert tube and bottom on the fitting shoulder
3. Assemble nut to body and tighten “hand tight”. Then wrench tighten the number of turns indicated in the table.



FITTING SIZE	TUBE SIZE	TURNS REQUIRED TO SEAL FROM HAND-TIGHT	
		60C WITH SOFT METAL TUBING	60PT WITH THERMOPLASTIC TUBING
2	1/8	1-1/4	—
3	3/16	1-1/4	—
4	1/4	1-1/4	2
5	5/16	1-1/4	2
6	3/8	2-1/4	2
8	1/2	2-1/4	2
10	5/8	2-1/4	2
12	3/4	2-1/4	2
14	7/8	2-1/4	—

Compress-Align

With nut finger tight on fitting body, insert tubing until it bottoms in the Fitting. Complete the seal with one wrench turn for all sizes.



Poly-Tite

1. Cut tubing squarely – maximum of 15° angle allowable.
2. Check that port or mating part is clean and free of debris.
3. Insert tube end until it bottoms in the Poly-Tite fitting and tighten knurl/hex nut finger-tight, plus one wrench turn.



Hi-Duty

1. Cut tube squarely and cleanly removing all burrs.
2. Grasp fitting. Do not remove nut.
3. Insert tube in fitting through nut until tube seats firmly against tube shoulder in body.
4. Grip tube firmly to prevent turning and tighten nut to finger-tight. Continue to tighten for one and three-quarter additional turns (one and one-half turns for 1/2" size fittings) for a positive, leak proof seal. During tightening a slight “give” will be felt. This “give” indicates the sleeve has been sheared from the nut. It is not necessary to tighten the nut all the way down.



45° Flare Fittings

1. Cut tubing squarely and clean tube end thoroughly to remove burrs.
2. Place nut onto tube. Place threaded end of nut toward end of tube.
3. Flare tube end with flaring tool to provide 45° flare.
4. Clamp tube flare between nut and nose of fitting body by screwing nut on finger-tight. Tighten with a wrench an additional 1/4 to 1/2 turn past finger-tight for a metal-to-metal seal.

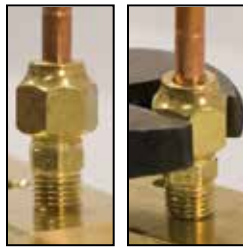

Inverted Flare

1. Cut tubing squarely and clean to remove burrs
2. Place nut onto tube. Place threaded end of nut toward end of tube.
3. Flare tube end with flaring tool to provide 45° flare
4. On thin wall copper, welded or brazed tubing, use double flare to prevent pinch-off or cracked flares
5. Clamp tube flare between nut and nose of fitting body by screwing nut on finger tight. Tighten nut with a wrench an additional 1/4 to 1/2 turn past finger tight for a metal-to-metal seal.



Dubl-Barb

Cut tube squarely and simply push tube over the two barbs



Hose Barbs

1. Cut hose cleanly and squarely to length.
2. Slide clamp on hose.
3. Lubricate hose. Push hose on fitting until bottomed against stop ring or hex.
4. Position hose clamp as shown and secure with a screwdriver or wrench. Maintain "A" dimension for proper clamp positioning.



HOSE SIZE	HOSE CLAMP	A
3/16	97 HC-3	1/4
1/4	97 HC-3	1/4
5/16	97 HC-6	1/4
3/8	97 HC-6	1/8
1/2	97 HC-8	1/8
5/8	97 HC-12	1/8
3/4	97 HC-12	1/8

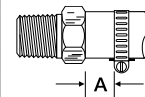

Pipe Fittings

Straight Fittings

1. Hand tighten external thread into internal thread
2. Tighten an additional 2 turns with a wrench up to 1/2" male pipe thread.
3. Above 1/2" 1 1/2 to 2 1/2 turns.

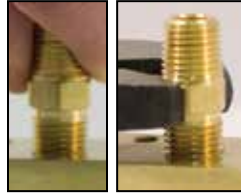

Elbow or Tee Fittings

1. Hand tighten external thread into internal thread
2. Tighten an additional 1 to 1 1/2 turns with a wrench
3. Tighten fitting, clockwise to align with tubing. (Never counter clockwise)

Note: To minimize the possibility of a leaking threaded joint after assembling Male to female pipe threads, neither end should be backed out (loosened) Once the assembly has been made.

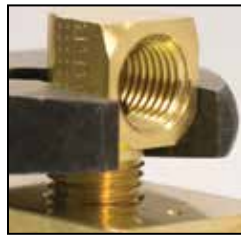
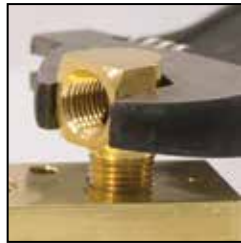

Plug Valves

To assure sealability and reliable performance, the valve must be installed So that the flow media travels in the direction of the arrow on the valve handle.



Needle Valves

Needle valves should always be installed with the pressure against the seat.

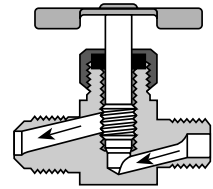

Fluid Compatibility Guide

The following pages list general recommendations for the selection of valve materials. For specific cases, and for those not included in the Fluid Compatibility Chart, it is advisable to check with your Parker representative.

There are many specific environmental factors which might affect corrosion rate such as temperature, solution,

concentration and presence of impurities. Therefore, we suggest that the information be used as a rough guide to material selection. If any questions exist regarding the expected performance of a material in a given application, actual tests should be performed to determine the suitability of the materials in question.

FLUID	BRASS	CARBON STEEL	316 S.S.	BUNA N (NITRILE)	NEOPRENE	EPR	FLUORO-CARBON	PTFE	ACETAL	NYLON
ACETALDEHYDE	P	G	E	P	G	G	P	E	U	
ACETAMINE	G	G	G	E	G			E		
ACETATE SOLVENTS	E	E	E	P			U	E	U	
ACETIC ACID VAPORS	U		U	U				E		
ACETIC ACID (10%)	P	P	E	U	P	G	U	E	U	U
ACETIC ACID (80%)	P	P	E	U	U	P	U	E	U	U
ACETIC ACID (AERATED)	P	P	E	G	G		P	E	U	
ACETIC ACID (AIR FREE)	P	P	E	G	G		U	E	U	
ACETIC ACID (CRUDE)	P	P	E	U	U		U	E	U	
ACETIC ACID (GLACIAL)			U	U	P	G	P	E		U
ACETIC ACID (PURE)	P	U	E	U	U		U	E	U	
ACETIC ANHYDRIDE	U	U	G	U	P	P	U	E	U	U
ACETONE	E	E	E	U	U	E	U	E	E	E
ACETOPHENONE	G	G	G	U	U	E	U			
ACETYL CHLORIDE	E	G	P	U	U	U	U	E		
ACETYLENE	G	E	E	G	P	E	E	E	E	
ACID FUMES	U	U	G	P	G			E		
ACRYLONITE	E	E	E	U	U	U	P	E		
AIR	E	E	E	E	E	E	E	E	E	
ALCOHOL, AMYL	G	G	E	P	P	E	G	E	E	
ALCOHOL, BUTYL	G	G	E	G	G	P	E	E	E	
ALCOHOL, DIACETONE	E	E	E	U	P	G	U	E		
ALCOHOL, ETHYL	G	G	G	E	G	E	E	E	E	
ALCOHOL, ISOPROPYL	G	G	G	P	G	E	E	E	E	
ALCOHOL, METHYL	E	G	E	G	E	E	P	E		E
ALCOHOL, PROPYL	E	G	E	G	G	E	E	E		
ALCOHOLS, FATTY	G	G	E	G	G			E		
ALUM	U		G	G	G		G	E		
ALUMINA	U		E	E	E	E		E		
ALUMINUM ACETATE	G		E	U	U	E	U	E		
ALUMINUM BROMIDE				E	E	E	E			
ALUMINUM CHLORIDE DRY	U	P	P	G	G	E	E	E	E	
ALUMINUM CHLORIDE SOLUTION			U	G	G		E	E		U
ALUMINUM FLUORIDE	U	U	P	E	E	E	E	E		U
ALUMINUM HYDROXIDE	E	U	E	E	E	E	E	E		
ALUMINUM NITRATE	U	U	P	G	G	G	U	E		
ALUMINUM OXALATE			U					E		
ALUMINUM SALTS				E	E	E	E			
ALUMINUM SULFATE	P	U	G	E	E	E	E	E	E	P
AMINES	G	G	E	U	U	P	U	E	E	
AMLY CHLORIDE	G		E	U	P	U	U	E		
AMMONIUM BICARBONATE	G	P	G	G	E	E	E	E	E	
AMMONIA, ALUM			E	G	G			E		
AMMONIA, ANHYDROUS LIQUID	U	E	E	G	P	G	U	E		
AMMONIA, AQUEOUS	U	E	E	G	G		E	E		
AMMONIA, GAS, HOT	U	G	E	P	E	E	U	E		
AMMONIA LIQUOR			E					E		
AMMONIA SOLUTIONS	U	G	E	G	G	G	U	E		
AMMONIUM ACETATE	U		G	G	G	E	U	E		
AMMONIUM BROMIDE 5%			G					E		

E-EXCELLENT

G-GOOD

P-POOR

U-UNSATISFACTORY



FLUID	BRASS	CARBON STEEL	316 S.S.	BUNA N (NITRILE)	NEOPRENE	EPR	FLUORO-CARBON	PTFE	ACETAL	NYLON
AMMONIUM CARBONATE	G	G	G	P	E	E	G	E	E	
AMMONIUM CHLORIDE	U	U	P	G	E	E	E	E	E	U
AMMONIUM HYDROXIDE 28%	U	P	G	G	E	G	E	E	E	
AMMONIUM HYDROXIDE CONC.	U	P	G	P	E	E	E	E	E	
AMMONIUM MONOSULFATE			E				E	E	E	
AMMONIUM NITRATE	U	U	E	E	E	E	E	E	E	U
AMMONIUM OXALATE 5%			E				E	E	E	
AMMONIUM PERSULFATE	P	U	E	U	P	G	G	E	E	U
AMMONIUM PHOSPHATE	U	U	G	E	E	E	E	E	G	P
AMMONIUM PHOSPHATE DI-BASIC	P	U	G	E	E	E	E	E	E	
AMMONIUM PHOSPHATE TRI-BASIC	P	U	G	E	E	E	E	E	E	
AMMONIUM SULFATE	P	P	G	E	E	E	G	E	E	U
AMMONIUM SULFIDE	U	U	G	E	G	E	U	E	E	
AMMONIUM SULFITE	P	P	E	G	E	G	E	E	E	
AMYL ACETATE	G	P	G	U	U	G	U	E	G	P
AMYL BORATE				E	E	U	E			
AMYL CHLORONAPHTHALENE				U	U	U	E			
AMYL NAPHTHALENE				U	U	U	E			
ANILINE	U	P	G	U	U	P	P	E	E	P
ANILINE DYES	P	P	E	P	P	P	G	E	E	
ANIMAL OIL	G	G	G	E	G	G	E			
ANTIMONY TRICHLORIDE	U	U	U	P			G	E		
APPLE JUICE	P	U	G	E	E	G	E	E	E	
AQUA REGIA (STRONG ACID)	U	U	G	U	U	U	U	E		U
AROCLOR 1248	G	U	U	U	U	G	E			
AROCLOR 1254	G	U	U	U	U	G	E			
AROCLOR 1260	G	U	U	E	E		E			
AROMATIC SOLVENTS	E	P	E	U	U	U		E		
ARSENIC ACID	U	U	G	E	E	G	E	E	E	U
ASPHALT EMULSION	E	G	E	U	P	U	E	E	E	
ASPHALT LIQUID	E	G	E	P	P	U	E	E	E	
ASTM OIL, NO. 1	E	E	E	E	E	U	E			
ASTM OIL, NO. 2	E	E	E	E	G	U	E			
ASTM OIL, NO. 3	E	E	E	E	U	U	E			
ASTM OIL, NO. 4	E	E	E	E	U	U	E			
ASTM REFERENCE FUEL A	U	G	E	E	G	U	E			
ASTM REFERENCE FUEL B	U	G	E	E	U	U	E			
ASTM REFERENCE FUEL C	U	G	E	G	U	U	E			
BARIUM CARBONATE	G	G	G	G	E	E	E	E	E	
BARIUM CHLORIDE	G	P	G	E	E	E	E	E	E	E
BARIUM CYANIDE	P		G	G	G	G	G	E	E	
BARIUM HYDRATE	U		E					E	E	
BARIUM HYDROXIDE	P	P	G	E	E	G	E	E	E	
BARIUM NITRATE			E		G			E		
BARIUM SALTS				E	E	E	E			
BARIUM SULFATE	P	P	E	E	E	G	E	E	E	E
BARIUM SULFIDE	U	P	G	E	G	E	E	E	E	
BEER	G	U	E	G	G	G	E	E	E	U
BEET SUGAR LIQUORS	E	G	E	E	E	G	E	E	E	
BENZALDEHYDE	E	E	E	U	U	E	U	E	E	E
BENZENE	G	G	G	U	U	U	G	E		E
BENZENESULFONIC ACID, 10%	U	U	U	U	G	U	E			
BENZLY CHLORIDE	U	U	G	U	U	U	E			
BENZOIC ACID	G	U	G	P	P	U	G	E		P
BENZYL ALCOHOL		U	E	U	G	G	E			
BERYLLIUM	G		G	G	G	G	G	E		
BLEACH LIQUOR				U	G	E	E			
BLEACHING POWDER WET	G		P	U	E	G	G	E	E	
BLOOD	G		E	G	G	G	G	E	E	
BORAX	U	P	E	G	U	E	E	E	E	E
BORAX LIQUORS	E	P	G		P	E	E	E	E	
BORDEAUX MIXTURE			E					E	E	
BORIC ACID	P	U	G	G	G	G	E	E	E	G
BRAKE FLUID	G		G	U	P	G	U	E	E	
BRINES, SATURATED	G	U	G	E	G	E	E	E	E	
BROMINE, DRY	G	U	U	U	U	U	G	E	E	
BROMINE, WET	U	U	U	U	U		G	E	E	

E-EXCELLENT

G-GOOD

P-POOR

U-UNSATISFACTORY



FLUID	BRASS	CARBON STEEL	316 S.S.	BUNA N (NITRILE)	NEOPRENE	EPR	FLUORO-CARBON	PTFE	ACETAL	NYLON
BUNKER OILS (FUEL)	G	G	E	G	G		E	E	E	
BUTADIENE	P	G	E	P	P	P	G	U		
BUTANE	E	G	E	G	G	U	E	E	E	
BUTTER	G	U	E	G	G			E		
BUTTERMILK	U	U	E	E	E	G	E	E	E	
BUTYL ACETATE	G	U	G	U	U	U	U	E		E
BUTYL ALCOHOL	E	P	E	G	G		G	E		
BUTYL AMINE	G	G	E	U	U		U	E		
BUTYL BUTYRATE				U	U	E	E			
BUTYL CARBITOL	E	P	E	U	U		U	E		
BUTYL CELLOSOLVE	E	P	E	U	U		G	E		
BUTYL STEARATE				G	U	U	E			
BUTYLENE	E	E	E	U	U	U	U	E		
BUTYRIC ACID	P	U	G	P	P	P	P	E	E	U
CALCINE LIQUORS				E		E	E			
CALCIUM ACETATE				G	G	E	U			
CALCIUM BISULFITE	P	U	G	E	E	U	E	E	E	
CALCIUM CARBONATE	P	U	G	E	E	G	E	E	E	
CALCIUM CHLORATE	U		G	G	G	G	G	E		
CALCIUM CHLORIDE	G	P	G	E	E	G	E	E	E	U
CALCIUM HYDROXIDE	P	P	G	E	G	E	E	E	E	
CALCIUM HYPOCHLORITE	U	U	P	P	P		E	E	E	U
CALCIUM NITRATE			G	G	G	G	G	E		
CALCIUM PHOSPHATE	P		G	G	G	G	G	E		
CALCIUM SALTS				E	E	E	E			
CALCIUM SILICATE	P		G	G	G	G	G	E		
CALCIUM SULFATE	P	P	G	E	E	G	E	E	E	U
CALCIUM SULFIDE	U	U	G	E	E	E	E			
CALICHE LIQUOR		G		G	G			E		
CAMPHOR	P		E	G	G	G	G	E		
CANE SUGAR LIQUORS	G	G	E	G	G	G	G	E		
CARBOLIC ACID	U	U	G	G	G	G	E	E	U	
CARBON BISULFIDE	P	G	G	U	U	U	E	E	E	
CARBON DIOXIDE, DRY	E	E	E	P	G	G	G	E	E	
CARBON DISULFIDE	U	P	E	U	U		E	E	E	
CARBON MONOXIDE	E	E	E	G	U	G	G	E		
CARBON TETRACHLORIDE, DRY	P	G	E	U	U	U	G	E	E	
CARBON TETRACHLORIDE, WET	U	U	G	U	U	U	G	E	E	
CARBONATED BEVERAGE	G	U	G	U	G	G	G	G		E
CARBONATED WATER	G	G	E	E	E	E	E	E	E	
CASEIN	P			G	G	G	G	G	E	
CASTER OIL	E	G	E	E	G	G	E	E	E	
CAUSTIC POTASH			E	G	G			E		
CAUSTIC SODA		G	E	P		G	G	E		
CELLULOSE ACETATE	G		G	U	U	G	U	E		
CELLULUBE	E		E	U	U		U	E		
CHINA WOOD OIL	P	P	E	E	G	U	E	E	E	
CHLORACETIC ACID	P	U	U	U	P		P	E		U
CHLORINATED SOLVENTS	P	P	E	U	U	U	P	E	E	
CHLORINATED WATER	U	P	G	E		E	E	E	U	U
CHLORINE, WET	U	U	U	U	U			E		
CHLORINE GAS	P	G	G	P	U	U	G	E	E	
CHLORO BROMO METHANE	G	U	G	U	U		G	E		
CHLOROBENZENE, DRY	G	G	E	U	U	U	E	E	E	E
CHLOROBUTADIENE				U	U	U	E			
CHLOROFORM, DRY	G	G	E	U	U	U	G	E	E	U
CHLOROPHYLL, DRY	G		G	G	G	G	G	E		
CHLOROSULFONIC ACID, DRY	P	G	G	U	U	U	U	E		U
CHLOROSULFONIC ACID, WET	U	U	U	U	U		P	E		
CHLORPHENOL				U	U	U	E			
CHROME ALUM	P	G	E	G	G	G	G	E		
CHROMIC ACID <50%	U	U	P	U	U	P	P	E	U	U
CHROMIC ACID >50%	U	U	P	U	U	P	P	E		
CHROMIUM SULFATE	P		G	G	G	G	G	E		
CIDER			E					E		
CITRIC ACID	P	U	G	G	E	G	E	E		P
CITRUS JUICES	G	U	G	E	E		E	E	E	

E-EXCELLENT

G-GOOD

P-POOR

U-UNSATISFACTORY



FLUID	BRASS	CARBON STEEL	316 S.S.	BUNA N (NITRILE)	NEOPRENE	EPR	FLUORO-CARBON	PTFE	ACETAL	NYLON
COCA-COLA SYRUP			E	G	G		G	E		
COCONUT OIL	G	P	E	E	P	E	E	E	E	
COFFEE	E		G	E	E	E	E	G		
COFFEE EXTRACTS, HOT	G	P	E					E		
COKE OVEN GAS	P	G	E	P	U	U	G	E		
COOKING OIL	G	G	E	E	G	U	E	E	E	
COPPER ACETATE	U	U	E	P	P	G	U	E		
COPPER CARBONATE			E					E		
COPPER CHLORIDE	U	U	P	G	G		E	E		U
COPPER CYANIDE	U		E	E	E	G	G	E		E
COPPER NITRATE	U	U	G	E	E	G	E	E	E	U
COPPER SALTS					E	E	E	E		
COPPER SULFATE	U	U	G	E	E	E	E	E	E	P
CORN OIL	G	P	G	E	P	P	E	E	E	
COTTONSEED OIL	G	P	G	E	G	P	G	E	E	
CREOSOTE OIL	G	G	G	P	U	U	E	E		U
CREOSOLS	U	G	G	U	U	U	U	E		
CRESYLIC ACID	P	P	G	U	U	U	G	E	U	U
CRUDE OIL, SOUR	P	G	E	E	G	U	E	E		
CRUDE OIL, SWEET	G	G	E	E	G		E	E		
CUPRIC NITRATE			E					E		
CUTTING OILS, WATER EMULSIONS	E	G	E	E	G		E	E		E
CYANIDE PLATING SOLUTION	U		G	G	G	G	G	E		
CYCLOHEXANE	E	E	E	P	U	U	E	E	E	
CYCLOHEXANONE	G		E	U	U			E		
DECANE				E	U	U	E			
DENATURED ALCOHOL				E	E	E	E			
DETERGENTS, SYNTHETIC	G	U	G	G	G	G	E	E		
DEXTRIN	G		G	G	G	G	G	E		
DIACETONE ALCOHOL	E	E	E	U	P			E		
DICHLOROETHANE			P	U	U	U		E		
DICHLOROETHYL ETHER	G		G	U	U	U	U	E		
DIESEL OIL FUELS	E	E	E	E	P	U	E	E		
DIETHYL BENZENE			G	U	U	U		E		
DIETHYL SULFATE	G		G	P	P	P	G	E		
DIETHYLAMINE	G	E	E	G	P	P	U	E		
DIETHYLENE GLYCOL	G	E	E	E	E	E	G	E		
DIMETHYL FORMAMIDE	G		E	G	U	U	U	E		
DIMETHYL PHTHALATE			U	G	G		U	E		
DIOCTYL PHTHALATE	E		E	P	U	U	P	E		
DIOXANE	G		G	U	U	P	U	E		
DIPENTANE	E		E	G	U	U	G	E		
DISODIUM PHOSPHATE			G	G	G		G	E		
DOW CHEMICAL HD50-4					G	E	U			
DOW CORNING 200, 510, 550				G	E	E	E			
DOWTHERM	E	G	E	U	U	U	E	E	E	
DRILLING MUD	G	G	E	E	P	E	E	E	E	
DRY CLEANING FLUIDS	P	G	E	U	U		G	E	E	
DRYING OIL	P	P	G	E	G			E	E	
ENAMEL	E		E	G	G	U		E		
EPSOM SALTS	G	P	G	E	E		E	E	E	
ETHANE	G	P	G	E	G	U	E	E	E	
ETHANOL	E	U	U	U	E	E	U			
ETHANOLAMINE	U	G	E	G	P		U	E		
ETHERS	G	E	E	U	U	P	P	E	P	
ETHYL ACETATE	P	G	G	U	U	P	U	E	E	E
ETHYL ACRYLATE	G	P	E	U	U	P	U	E		
ETHYL ALCOHOL	G	G	G	E	E		E	E		
ETHYL BENZENE			G	P	U	U		E	E	
ETHYL BROMIDE	E		G	G	G	G	G	E		
ETHYL CHLORIDE, DRY	G	G	E	P	P	P	G	G	E	E
ETHYL CHLORIDE, WET	P	U	E	P	P	G	G	E		
ETHYL ETHER	G		E	U	U	U	U	E		
ETHYL HEXANOL			E	E	E	E	E			
ETHYL SILICATE	G		G	G	P	G	G	E		
ETHYL SULFATE			G	G	G	P	E	E	E	

E-EXCELLENT

G-GOOD

P-POOR

U-UNSATISFACTORY



FLUID	BRASS	CARBON STEEL	316 S.S.	BUNA N (NITRILE)	NEOPRENE	EPR	FLUORO-CARBON	PTFE	ACETAL	NYLON
ETHYLENE CHLORIDE			E	U	E		U	E		
ETHYLENE DICHLORIDE	U	U	G	U	U		U	E		
ETHYLENE GLYCOL	G	G	G	E	G		E	E		
ETHYLENE OXIDE	P	G	G	U	U		U	E		
FATTY ACIDS	P	U	E	G	G		U	E	E	U
FERRIC CHLORIDE	U	U	U	E	U		E	E		U
FERRIC HYDROXIDE			E	G				E		
FERRIC NITRATE	U	U	P	E	E		E	E	E	U
FERRIC SULFATE	U	U	G	E	E		E	E	E	U
FERROUS AMMONIUM CITRATE			G					E		
FERROUS CHLORIDE	G	U	U	E	E		E	E	E	U
FERROUS SULFATE	G	U	G	E	E		E	E	E	U
FERROUS SULFATE, SATURATED	P	P	E	P	P		G	E		
FERTILIZER SOLUTIONS	P	G	G	G	G			E	G	
FISH OILS	G	G	E	E	G		U	E	G	
FLUE GASES	G		E	P	P		U	P	E	
FLUOBORIC ACID			G	E	G			E		U
FLUORINE, DRY	U		U	U					E	
FLUROSILICIC ACID	G	U	G	P	P		P	E		U
FOOD FLUIDS & PASTES	G	P	E	G	E			E		
FORMALDEHYDE, COLD	E	E	E	G	P		G	U	E	U
FORMALDEHYDE, HOT	G	U	P	G	G			E	E	U
FORMIC ACID, COLD	G	U	G	U	G			G	E	E
FORMIC ACID, HOT	G	U	G	U	E			E	E	U
FRUIT JUICES	G	U	E	E	E		E	E	E	
FUEL OIL	G	G	E	E	P		U	E	E	
FUMARIC ACID			G	G	G			E		
FURFURAL	E	E	E	U	P		P	U	E	E
GALIC ACID 5%	P	U	G	G	G		P	E	E	
GAS, NATURAL	G	G	E	E	E		U	E	E	
GAS, ODORIZERS	E	G	G	G	G			E	E	
GAS MFG.	G	G	G	E				E	E	
GASOLINE, AVIATION	E	E	E	P	U			E	E	E
GASOLINE, LEADED	E	E	E	P	U			E	E	
GASOLINE, MOTOR	E	E	E	P	U			U	E	
GASOLINE, REFINED	G	G	E	P	P			U	E	
GASOLINE, SOUR	G	G	E	P	U			U	E	
GASOLINE, UNLEADED	E	E	E	P	U			E	E	E
GELATIN	E	U	E	E	E			E	E	
GLUCOSE	E	G	E	E	E			E	E	
GLUG	E	G	E	E	G			E	E	
GLYCERINE	G	P	E	P	U			E	G	E
GLYCOL	G	P	G	G	E			E	E	
GLYCOL AMINE	U		G	E				U	U	
GRAPHITE	G		G	G	G			G	E	
GREASE	P	E	E	E	G			U	E	
GULF-FR FLUID, EMULSION			E	E	G			U	E	
GULF-FR FLUID G			E	E	E			E	E	
GULF-FR FLUID P			U	U	U			G	G	
HELIUM GAS	G	E	E	G	G			G	E	
HEPTANE	E	G	E	E	G			U	E	
HEXANE	G	G	E	E	P			U	E	E
HEXANOL, TERTIARY	E	E	E	E	P			U	E	
HEXYL ALCOHOL	E	P	E	U	P			E	E	
HYDRAULIC OIL, PETROLEUM BASE	G	E	E	E	G			U	E	
HYDRAZINE	U	U	G	P	P			G	U	
HYDRIGEN SULFIDE, DRY	P	G	E	P	E			E	E	
HYDROCHLORIC ACID, AIR FREE	U	U	U	G	P			E	E	U
HYDROCYANIC ACID	U	U	E	G	G			G	E	
HYDROFLUORIC ACID	U	U	U		G					U
HYDROFLUOSILICIC ACID	E	U	P	G	G			G	E	U
HYDROGEN GAS, COLD	G	G	E	G	G			G	E	
HYDROGEN GAS, HOT	G	G	G	G	G			E	E	
HYDROGEN PEROXIDE, CONCENTRATED	U	U	G	U	U			G	E	U
HYDROGEN PEROXIDE, DILUTE	P	U	G	E	G			G	E	U
HYDROGEN SULFIDE, WET	U	P	G	P	G			E	E	

E-EXCELLENT

G-GOOD

P-POOR

U-UNSATISFACTORY



FLUID	BRASS	CARBON STEEL	316 S.S.	BUNA N (NITRILE)	NEOPRENE	EPR	FLUORO-CARBON	PTFE	ACETAL	NYLON
HYDROLUBE				E	G	E	E			
HYPO (SODIUM THIOSULFATE)	P	U	G	E	E	E	E	E	E	
HYPOCHLORITES, SODIUM	U	U	P	P			E	E		
ILLUMINATING GAS	E	E	E	P	P	U	E	E		
INK, NEWSPRINT	P	U	E	E	G	G	E	E	E	
IODINE, WET	U	U	U	G			E	E		
IODIFORM	P	G	E				E	E	E	
ISOPROPYL ACETATE			G	U	U	U		E		
ISOPROPYL ALCOHOL	G	G	G	P	G		E	E		
ISOPROPYL ETHER	E	E	E	P	P	U	U	E		
ISO-BUTANE			G	G	U	U		E		
ISO-OCTANE	E	E	E	E	P	U	E	E		E
J P-4 FUEL	E	E	E	E	P		E	E	E	
J P-5 FUEL	E	E	E	G	P		E	E	E	
J P-6 FUEL	E	E	E	E	P		E	E	E	
KEROSENE	E	G	E	E	P	U	E	E	E	
KETCHUP	U	U	E	E	E		E	E	E	
KETONES	E	E	E	U	U	U	U	E	E	
LACTIC ACID, CONC. COLD	U	U	E	G	E	G	E	E	U	U
LACTIC ACID, CONC. HOT	U	U	G	P	P	G	G	E	U	U
LACTIC ACID, DILUTE COLD	U	U	E	G	E	G	E	E	U	U
LACTIC ACID, DILUTE HOT	U	U	E	P	U		U	E	U	U
LACTOSE	G		G	G	P	G	G	E		
LAQUER	E	P	E	U	U	U	U	E	E	E
LARD	G	E	E	G	P	P		E		
LARD OIL	G	P	G	E	G	G	E	E	E	
LEAD ACETATE	P	U	G	E	G	G	G	E	E	E
LEAD SULFATE	P		G	G	G	G	G	E		
LECITHIN	P		G	U	U	U	G	E		
LINOLEIC ACID	G	G	E	G	G	U	G	E	E	
LINSEED OIL	G	E	E	E	P	U	E	E	E	
LITHIUM CHLORIDE	G		G	G	G	G	G	E		
LPG	E	G	G	E	G	U	E	E	E	
LUBRICATING OIL	G	E	E	E	G	U	E	E	E	
LUDOX	U		G	G	G	G	G	E		
MAGNESIUM BISULFATE	G	G	E	G	G	G	G	E		
MAGNESIUM BISULFIDE	U		G	G	G	G	G	E		
MAGNESIUM CARBONATE	G		G	E	G	G	G	E		
MAGNESIUM CHLORIDE	G	P	E	E	E	E	E	E	E	E
MAGNESIUM HYDROXIDE	G	G	E	E	E	E	E	E	E	
MAGNESIUM HYDROXIDE HOT	U	G	E	G	G		E	E	E	
MAGNESIUM NITRATE			E	G	E		G	E		E
MAGNESIUM SALTS				E	E	E	E			
MAGNESIUM SULFATE	G	G	E	E	E	E	E	E	E	E
MALEIC ACID	G	G	G	G	G	U	E	E	E	
MALEIC ANHYDRIDE	G		G	U	U	U	G	E		
MALIC ACID	G	U	G	E	G		E	E	E	
MALT BEVERAGES			E	E	E	G	E	E		
MANGANESE CARBONATE			G	G				E		
MANGANESE SULFATE	G		E	G	G	G	G	E		
MAYONNAISE	U	U	E	E	E		E	E	E	
MEAT JUICES	U		E	G	G			E		
MELAMINE RESINS			P	G	G			E		
MERCURIC CHLORIDE	U	U	G	E	G	E	E	E		
MERCURIC CYANIDE	U	U	E	E	G		E	E		
MERCUROUS NITRATE	U		E				G	E		
MERCURY	U	E	E	E	E	E	E	E		E
METHANE	E	G	E	E	G		E	E		
METHANOL	E	E		E	E	E	U		E	
METHANOL	G		E	G	G	U	G	E		
METHYL ACETATE	E	G	E	U	U	G	U	E		
METHYL ACETONE	E	E	E	E	U	E	U	E		
METHYL ALCOHOL	G	G	G	U	G		P	E		E
METHYL BROMIDE 100%	P	G	G	G	U	U	G	E		
METHYL CELLOSOLVE	E	G	E	P	U	G	U	E		
METHYL CELLULOSE			E	U	U			E		
METHYL CHLORIDE	G	G	E	U	U	U	G	E	E	

E-EXCELLENT

G-GOOD

P-POOR

U-UNSATISFACTORY



FLUID	BRASS	CARBON STEEL	316 S.S.	BUNA N (NITRILE)	NEOPRENE	EPR	FLUORO-CARBON	PTFE	ACETAL	NYLON
METHYL ETHER				E	U	U	E			
METHYL ETHYL KETONE	E	E	E	U	U	G	U	E	E	E
METHYL FORMATE	E	P	G	U	U	G	U	E		
METHYL ISOBUTYLE KETONE			E	U	U			E		
METHYLAMINE	U	G	E	U	U	G	U	E		
METHYLENE CHLORIDE	E	G	E	U	U	U	P	E		U
MILK & MILK PRODUCTS	G	U	E	E	E	E	E	E	E	
MIL-F-81912, JP-9	E	E	E	U	U	U	E			
MIL-H-5606	E	E	E	E	G	U	E			
MIL-H-6083	E	E	E	E	E	U	E			
MIL-H-7083	E	E	E	E	G	E	G			
MIL-H-8446	G	E	E	G	E	U	E			
MIL-L-2104 & 2104B	E	E	E	E	G	U	E			
MIL-L-7808	U	G	E	G	U	U	E			
MINE WATERS, ACID	P	U	P	E			E	E		
MINERAL OILS	G	G	E	E	G	U	E	E	E	
MINERAL SPIRITS	G	G	G	E	P		E	E	E	
MIXED ACIDS, COLD	U	P	G	U	U	U	G	E	U	
MLO-7277 & MLO-7557	G	E	E	U	U	U	E			
MOBILE HF	E	E	E	E	G	U	E			
MOLASSES, CRUDE	E	E	E	E	E		E	E	E	
MOLASSES, EDIBLE	E	P	E	E	E		E	E	E	
MOLYBDIC ACID			E				E	E		
MONOCHLORO BENZENE DRY			G	U	U			E		
MONOMETHYL HYDRAZINE				G	G	E				
MORPHOLINE	G		E	U	U	G	U	E		
MURIATIC ACID	U	U	U	G			E	E		
MUSTARD	E	G	E	E	E		E	E	E	
NAPHTHENIC ACID	G	E	G	G	U	U	E			
NAPTHA	G	G	G	G	P	U	E	E	E	
NAPHTHALENE	G	G	G	U	U	U	E	E	E	
NATURAL GAS, SOUR	G	G	E	E	E	U	E	E		
NEATSFOOT OIL				E	U	G	E			
NICKEL ACETATE	U	G	E	G	G	E	U			
NICKEL AMMONIUM SULFATE	U	U	E	E	G	G	U	E		
NICKEL CHLORIDE	U	U	G	E	E	G	E	E	E	E
NICKEL NITRATE	U	U	G	E	E	E	E	E	E	
NICKEL SALTS				E	G	E	E			
NICKEL SULFATE	U	U	G	E	E	G	E	E	E	E
NITRIC ACID 100%	U	U	E	U	U	U	G	E	U	U
NITRIC ACID 10%	U	U	E	P	G		E	E	U	U
NITRIC ACID 30%	U	U	E	P	P	G	E	E	U	U
NITRIC ACID 80%	U	U	P	U	U	U	G	E	U	U
NITRIC ACID ANHYDROUS	U	U	E	U	U	U	E	E		
NITROBENZENE	U	G	E	U	U	P	P	E		E
NITROGEN	E	E	E	E	E	G	E	E	E	
NITROUS ACID 10%	U	U	G	P	E		E	E	E	
NITROUS GASES	U	G	E					E		
NITROUS OXIDE	G	G	G	G	G		E	E		
NOCOTINIC ACID	E	G	E	U	U	U	G	E		
OCTYL ALCOHOL	E	E	E	G	G		E			
OILS, ANIMAL	E	E	E	E	G	G	G	E		
OILS, PETROLEUM REFINED	G	E	E	E	G	U	E	E	E	
OILS, PETROLEUM SOUR	P	G	E	G	G	U	E	E		
OILS, WATER MIXTURE	E	G	E	E	G		E	E	E	
OILS & FATS			E	G		U		E		
OLAIC ACID			G	U	U		P	E		
OLEIC ACID	G	P	G	G	P	U	E	E	E	
OLEUM	P	G	G	U	U	U	P	E	U	
OLEUM SPIRITS	U		G	P	U	U	E	E		
OLIVE OIL	P	G	E	E	G	G	E	E	E	
ORTHO-DICHLOROBENZENE	G	G	E	U	U	U	E	E	E	
OTHER KETONES	E	E	E	U	U	U	U	E		
OXALIC ACID	G	U	G	P	G	G	E	E	P	U
OXYGEN	E	G	E	G	G	E	E	E	U	
OZONE, DRY	E	E	E	U	U	E	G	E		
OZONE, WET	G	P	E	U	U	G	G	E		

E-EXCELLENT

G-GOOD

P-POOR

U-UNSATISFACTORY



FLUID	BRASS	CARBON STEEL	316 S.S.	BUNA N (NITRILE)	NEOPRENE	EPR	FLUORO-CARBON	PTFE	ACETAL	NYLON
PAINTS & SOLVENTS	E	E	E	U	U	U	G	E		
PALM OIL	G	P	G	G	G	U	E	E	E	
PALMITIC ACID	G	P	G	G	G	G	E	E	E	
PAPER PULP	G		E	G	G	G	G	E		
PARAFFIN	E	G	E	E	P	U	E	E	E	
PARAFORMALDEHYDE	G	G	G	G	G	U		E	E	
PARALDEHYDE			G	G	G	U		E		
PARA-DICHLOROBENZENE	G	E	E	U	U	U			E	
PARKER O LUBE	E	E	E	E	E	U	E			
PEANUT OIL	G	E	E	E	U	U	E			
PENTANE	E	G	E	E	G	U	E	E	E	
PERCHLORETHYLENE, DRY	P	G	E	U	U	U	E	E		
PERCHLORIC ACID-2N	U	U	G	U	G	G			E	
PETROLATUM (PETROLEUM JELLY)	G	P	G	E	G		E	E	E	
PHENOL	G	U	E	U	U	U	G	E	U	E
PHOSPHATE ESTER	U	E	E	U		E		E		
PHOSPHORIC ACID 10%	U	U	U	G	E	G	E	E	U	U
PHOSPHORIC ACID 50% COLD	U	U	G	G	G	G	E	E	U	U
PHOSPHORIC ACID 50% HOT	U	U	U	G	G	G	E	E	U	U
PHOSPHORIC ACID 85% COLD	G	G	E	P	P		G	E	U	U
PHOSPHORIC ACID 85% HOT	P	P	G	P	P			E	U	U
PHOSPHORIC ANHYDRIDE			E	U	U		G	E	G	
PHOSPHOROUS TRICHLORIDE	U	G	E	U	U	G	G	E		
PHTHALIC ACID	G	P	G	P	P		E	E	E	
PHTHALIC ANHYDRIDE	G	P	G	P	P		E	E	E	
PICRIC ACID	P	U	G	P	E	G	G	E		
PINE OIL	G	G	E	E	U	U	E	E	E	
PINEAPPLE JUICE	P	P	E	E	E		E	E	E	
PITCH			E	P	P	U		E		
PLATING SOLUTIONS, CHROME	E	U	E		U	E	E			
PLATING SOLUTIONS, OTHER		E	E	E	U	E	E			
PNEUMATIC SERVICE	E	E	E	E	E	E	E	E		
POLYSULFIDE LIQUOR	U		G	G	G	G	G	E		
POLYVINYL ACETATE	G		G		P	G		E		
POLYVINYL CHLORIDE	G		G		P	G		E		
POTASSIUM ACETATE	G	E	G	G	G	E	U			
POTASSIUM BICARBONATE			E	G				E		E
POTASSIUM BICHROMATE			E	G	G		G	E	G	
POTASSIUM BISULFATE			E	G	G		E	E		
POTASSIUM BISULFITE	P	U	G	E	E	G	E	E	E	
POTASSIUM BROMIDE	P	U	E	E	E	G	E	E	E	P
POTASSIUM CARBONATE	G	G	G	E	E	G	E	E	E	P
POTASSIUM CHLORATE	G	G	G	E	E	G	E	E	E	P
POTASSIUM CHLORIDE	P	P	G	E	E	E	E	E	E	P
POTASSIUM CHROMATE	G		G	G	E	G	G	E		
POTASSIUM CYANIDE	U	G	G	E	E	E	E	E	E	E
POTASSIUM DICHROMATE	U	P	G	E	E	G	E	E	E	U
POTASSIUM DIPHOSPHATE	G	E	E	E			E	E		
POTASSIUM FERRICYANIDE	U	P	E	E	E	G	E	E	E	
POTASSIUM FERROCYANIDE	G	P	G	E	E		E	E	E	
POTASSIUM HYDROXIDEDILUTE COLD	U	E	G	E	G		U	E		E
POTASSIUM HYDROXIDE DILUTE HOT	U	G	G	G	G			E		
POTASSIUM HYDROXIDE TO 70% COLD										
POTASSIUM HYDROXIDE TO 70% HOT	U	E	G	P	G	E			E	
POTASSIUM HYDROXIDE TO 70% HOT	U	E	G	P	G	E		E		
POTASSIUM IODIDE	U	P	G	E	E	G	E	E	E	
POTASSIUM NITRATE	G	G	G	E	E	G	E	E	E	P
POTASSIUM OXALATE			E					E		
POTASSIUM PERMANGANATE	G	G	G	E	E	G	E	E	E	U
POTASSIUM PHOSOHATE	P		G	E	E	E	E	E		
POTASSIUM PHOSPHATE DI-BASIC	G	E	E	E	E	G	E	E	E	
POTASSIUM PHOSPHATE TRI-BASIC		E	G	E	G	G		E		
POTASSIUM SALTS			E	G	E	E	E			
POTASSIUM SULFATE	G	G	E	E	E	E	E	E	E	P
POTASSIUM SULFIDE	G	G	E	E	G	G	G	E		
POTASSIUM SULFITE	G	G	E	E	G	E	G	E		
PRODUCER GAS	G	G	G	E	G	U	E	E	E	

E-EXCELLENT

G-GOOD

P-POOR

U-UNSATISFACTORY



FLUID	BRASS	CARBON STEEL	316 S.S.	BUNA N (NITRILE)	NEOPRENE	EPR	FLUORO-CARBON	PTFE	ACETAL	NYLON
PROPANE GAS	E	G	G	E	G	U	E	E	E	
PROPYL ACETATE	U	E	E	U	U	G	U			
PROPYL ALCOHOL	E	G	G	E	E		E	E		
PROPYL BROMIDE	G		G	G	G	G	G	E		
PROPYLENE	E	E	E	U	U	U	E			
PROPYLENE GLYCOL	G	G	G	E	E	G	E	E	P	
PYDRAUL	E	P	E	U	U		G	E		
PYRIDINE			G	U	U		U	E		
PYROGARD 42, 43, 53, 55				U	U	E	E			
PYROGARD D				E	G	E	E			
PYROLGALIC ACID	G	G	G	E	E		E	E	E	
QUENCH OIL	G	G	E	E	G		E	E	E	
QUININE, SULFATE, DRY			E					E		
R P-1 FUEL	E	E	E	G	P		E	E	E	
RESINS & ROSINS	E	P	E	P	P		E	E		
RESORCINOL			G					E		
ROAD TAR	E	E	E	G	P	U	E	E	E	
ROOF PITCH	E	E	E	G	P		E	E	E	
ROSIN EMULSION	G	P	E	U	P		G	E		
RUBBER LATEX EMULSIONS	E	G	E				E	E	E	
RUBBER SOLVENTS	E	E	E	U	P		U	E	P	
SALAD OIL	G	P	G	E	E	G	E	E	E	
SALICYLIC ACID	P	U	E	E	E	G	E	E	E	
SALT	G	P	G	E	E		E	E	E	
SALT BRINE	G		G	E	U	G	G	E		
SAUERKRAUT ARINE			G					E		
SEA WATER	P	U	G	E	E	E	E	E	E	
SEWAGE	P	P	G	E	P	G	G	E		
SHELL IRUS 905				E	G	U	E			
SHELLAC	E	E	E	E	E			E		
SILICONE FLUIDS	G		G	G	G		G	E		
SILVER BROMIDE										
SILVER CYANIDE	U		E	G	G		G	E		
SILVER NITRATE	U	U	E	P	P	E	E	E	E	
SILVER PLATING SOL.			E		G			E		
SKYDROL 500	E	G	E	U	U		U	E		
SKYDROL 7000, TYPE 2	U	E	E	U	U	E	G			
SOAP SOLUTIONS	E	E	E	E	G	E	E	E		
SODIUM ACETATE	G	P	G	G	G	G	E	E	E	E
SODIUM ALUMINATE	G	P	E	E	E	G	E	E	E	
SODIUM BENZOATE			G					E		
SODIUM BICARBONATE	G	P	G	E	E	E	E	E	E	E
SODIUM BICHROMATE			G	U				E		
SODIUM BISULFATE 10%	G	U	E	E	E	G	E	E	E	P
SODIUM BISULFITE 10%	G	U	E	E	E	G	E	E	E	P
SODIUM BORATE	G	P	G	E	E	G	E	E	E	
SODIUM BROMIDE 10%	G	P	G	E	E	G	E	E	E	
SODIUM CARBONATE	G	G	E	E	E	G	E	E	E	E
SODIUM CHLORATE	G	P	G	E	E	G	E	E	E	P
SODIUM CHLORIDE	G	P	G	E	E	G	E	E	E	E
SODIUM CHROMATE	P	G	E	E	E	G	E	E	E	
SODIUM CITRATE			G					E		
SODIUM CYANIDE	U	G	E	E	E	G	E	E	E	E
SODIUM FERRICYANIDE			E					E		
SODIUM FLUORIDE	P	U	G	E	E	G	E	E	E	
SODIUM HYDROXIDE 20% COLD	E	E	E	E	E	G	G	E		E
SODIUM HYDROXIDE 20% HOT	E	G	E	G	G	G	P	E		
SODIUM HYDROXIDE 50% COLD	E	E	E	E	E	G	P	E		E
SODIUM HYDROXIDE 50% HOT	E	G	E	E	G	G	P	E		
SODIUM HYDROXIDE 70% COLD	E	E	E	G	P	G	P	E		
SODIUM HYDROXIDE 70% HOT	G	G	E	U	U	G	P	E		
SODIUM HYPOCHLORITE (BLEACH)	U	U	U				E	E		U
SODIUM HYPOSULFITE			G					E		
SODIUM LACTATE			E					E		
SODIUM METAPHOSPHATE	P	G	G	E	E	G		E		
SODIUM METASILICATE COLD	G	P	E	G	E		G	E		
SODIUM METASILICATE HOT	G	U	E					E		

E-EXCELLENT

G-GOOD

P-POOR

U-UNSATISFACTORY



FLUID	BRASS	CARBON STEEL	316 S.S.	BUNA N (NITRILE)	NEOPRENE	EPR	FLUORO-CARBON	PTFE	ACETAL	NYLON
SODIUM NITRATE	G	G	E	P	G	G	E	E	E	E
SODIUM NITRITE			G	P	U	E	G	E	G	
SODIUM PERBORATE	G	G	G	P	G	E	E	E	E	
SODIUM PEROXIDE	U	P	G	P	G	E	E	E	E	
SODIUM PHOSPHATE	P	P	G	G	P	E	E	E	G	
SODIUM PHOSPHATE DI-BASIC	P	P	G	E	E	E	E	E	E	
SODIUM PHOSPHATE TRI-BASIC	P	P	G	G	G	E	E	E	E	
SODIUM POLYPHOSPHATE			G	G	G	E	E	E		
SODIUM SALICYLATE			E				E	E		
SODIUM SALTS										
SODIUM SILICATE	G	G	G	E	E	G	E	E	E	E
SODIUM SILICATE, HOT	P	P	G			G	E	E		
SODIUM SULFATE	G	G	E	E	E	E	E	E		E
SODIUM SULFIDE	U	G	G	E	E	G	E	E	E	E
SODIUM SULFITE	P		E	E	E	G	G	E		
SODIUM TETRABORATE			E	E	E	G		E		
SODIUM THIOSULFATE	P	G	G	E	E	E	E	E	E	
SOYBEAN	G	P	E	E	G	G	E	E	E	
STANNIC CHLORIDE	P	U	U	E	E		E	E		
STARCH	G	P	G	E	E	P	E	E	E	
STEAM (212 F)	E	E	E	U	U	G	P	E	U	
STEARIC ACID	P	P	G	E	P	G	E	E	E	
STODDARD SOLVENT	G	E	E	E	G	U	E	E		
STYRENE	E	E	E	U	U	U	G	E		
SUCROSE SOLUTIONS	E	E	E	E	G	E	E			
SUGAR, SYRUPS & JAM	G		E		G			E		
SUGAR LIQUIDS	E	G	E	E	E	G	E	E	E	
SULFATE, BLACK LIQUOR	P	P	G	P	G	G	P	E	E	
SULFATE, GREEN LIQUOR	P	P	G	P	G		P	E	E	
SULFATE, WHITE LIQUOR	P	P	G	P	G		P	E	E	
SULFUR	U	P	G	U	P	G	G	E	E	
SULFUR, MOLTEN	U	P	G	U	P	G	G	E		
SULFUR CHLORIDES	G	U	U	U	U	P	E	E	E	
SULFUR DIOXIDE, DRY	G	G	E	U	U	E	E	E	E	
SULFUR DIOXIDE, WET	U		E	U	U	G		E		
SULFUR HEXAFLUORIDE	G		E		G			E		
SULFUR TRIOXIDE	G	G	G	U	U		G	E		
SULFUR TRIOXIDE, DRY	G	G	G	U	U	G	E	E		
SULFURIC ACID 0 TO 77%	P	U	P	G	G		E	E	P	U
SULFURIC ACID 100%	P	P	E	U	U	P	G	E	U	U
SULFUROUS ACID	U	U	G	P	P	P	E	E	P	
SUNSAFE	U	E	E	E	G	U	E			
TALL OIL	G	G	G	G	G	U	E	E		
TANNIC ACID	G	P	G	G	G	G	E	E	E	U
TANNING LIQUORS			G	G	U			E		
TAR & TAR OILS	E	E	E	P	U	U	E	E		
TARTARIC ACID	G	U	E	P	G	G	E	E	E	
TERPINEOL				G	U	U	E			
TERTIARY BUTYL ALCOHOL	E	E	E	G	G	G	E			
TETRACHLOROETHANE		G	E	U	U	U	E			
TETRACHLOROETHYLENE	U	G	U	U	U	E				
TETRAETHYL LEAD	G	P	G					E	E	
TITANIUM TETRACHLORIDE	G	E	G	G	U	U	E			
TOLUOL (TOLUENE)	E	E	E	U	U	U	G	E	E	E
TOMATO JUICE	P	P	E	E	E		E	E		E
TRANSFORMER OIL	G	E	E	E	G		E	E	E	
TRANSMISSION FLUID, TYPE A	E	E	E	E	G	U	E			
TRIBUTYL PHOSPHATE	E	E	E	U	U	G	U	E		
TRICHLOROETHYLENE	G	G	G	U	U	U	G	E	E	U
TRICHLOROACETIC ACID	G		U	P	U		U	E		
TRICHLOROETHANE		G	E	U	U	U	E			
TRICRESYL PHOSPHATE		E	G	U	U	E	G			
TRITHANOLAMINE			G	P	G	G		E		
TRIETHYLAMINE	G		G	G	G			E		
TRISODIUM PHOSPHATE			G	E	E	G	G	E		
TUNG OIL	G	G	E	E	G	U	E	E	E	
TURBINE OIL #15		G	E	G	U	U	E		E	

E-EXCELLENT

G-GOOD

P-POOR

U-UNSATISFACTORY



1F H7	54GH J23	62PMTBH E13	68PLS A48
2GF H7	55GH J23	62PMTBHR E13	68PLSSP A49
3GF H7	56PSG G28	62PTBH G29	68PMT E14
4CB-SR L12	56RBSG F16	62PTC E10	68PMTBH E14
9-DC L13	59CA G13	62RB F16	68PMT-X-M E14
14FL H7	59HD G37	62TF F11	68PTC E10
14FS H7	59P G28	62VL F18	68RB F16
14FSV H7	60AB F13	63NTA F7	68RBSG F16
14FSX H7	60C G8	63PLM A44	68TF F11
16-CB L12	60NTA F7	63PLP A32	68VL F18
18-DC L13	60P G28	63PT G9, G13	69GH J23
20 I6	60PB G28	66AB F13	70GH J23
22 I6	60PT G8	66BBJ A26	71GH J23
22BH I6	60RB F16	66C G9	75GH J23
22CA I6	60TF F11	66CA G14	76RB F16
22CABH I6	60VL F18	66HD G35	78GH J23
24B-Cabinet L13	60VLV F18	66LF A14	79GH J23
24-CB L12	61AB F13	66NBH F7	80GH J23
24M E9	61C G8	66NTA F8	81GH J23
24PLP A29	61CA G13	66P G29	82GH J23
24PLPD A30	61CL G8	66PLM A38	83GH J23
26 I6	61HD G35	66PLMBH A42	88AC H18
27 I6	61NTA F7	66PLP A6	88GH J23
28 I6, I7	61P G28	66PLPBH A6	90GH J23
30GH C42	61PB G28	66PMT E13	93-FB-BPD M8
31GH C42	61PN G28	66PMTBH E14	94GH J23
31HB C42	61PSGN G28	66PTC E10	95GH J24
32PLCK B26	61RB F16	66RBSV F16	96GH J24
32PLP A27	61RBSG F16	66VL F18	97HC I10
32PLPBH A29	61TF F11	67PLM A43	97P G30
32PLPBHP A35	61VL F18	67PLP A33	98GH J24
32PLPDJ A26	62AB F13	67PLS A53	98GHSV J24
32PLPDJB A25	62ABH F13	67RBSG F16	99GH J24
32PLPDR A34	62ANBH F7	68ALS E23	99GHSV J24
32PLPRC A34	62C G8	68BJB A25	0101 G18, G19
32PLPSP A33	62CA G13	68BJBD A26	101GHSV J24
32PTC E7	62CABH G13	68BJBT A26	0102 G24
37PTCSP E8	62CBH G9	68C G9	102-F-XX-BPD M7
40B-Cabinet L14	62HD G35	68CA G14	0103 G22
41FL H8	62HDBH G35	68HB I10	0104 G24
41FS H8	62NBH F7	68HB-X-MI J21	0105 G18
41FX H8	62NFBH F7	68HB-X-MIX I10	0106 G23
41IF H14	62NTA F7	68HD G36	0107 G25
42F H8	62P G28, G29	68LF A16	0108 G21
42IFHD H14	62PBH G29	68LFR A15	0109 G20, G21
43F H8	62PCA G13, G29	68NTA-X-MI J21	0110 G25, G26
46F H9	62PCABH G13, G29	68NTA-X-MIX F8	0111 G25
46IFHD H14	62PLM A42	68P G30	0114 G20
48F H9	62PLMBH A42	68PLCK B27	0116 G24
48F-X-MI J21	62PLMSP A44	68PLCKI B27	0117 J14
48F-X-MIX H9	62PLP A6	68PLM A38	0118 G22
48IFHD H14	62PLPBH A6	68PLMSP A39	0119 G23
50CT L14	62PLS A52	68PLPR A7	0121 J14
50GHSV J23	62PLSBH A52	68PLPSP A23	122HBL I10
53GH J23	62PMT E13	68PLP-X-0 A7	122PLMSP A44

0123.....I13	0168.....G26, J15	177CA.....G16	252IFHDH15
0124.....G25	0169.....J15	177HDG37	255IFHDH15
0125.....G26	169C.....G10	177PG33	255MJ11
125HBI10	169CA.....G15	179C.....G11	256FH12
125HBLI10	169HB-X-MIJ21	179CA.....G16	259FH11
125HBLSV.....I11	169HB-X-MIXI12	179HBI12	259IFHDH15
126HBLI11	169HDG36	179HB-X-MII13, J21	264AB.....F13
0127.....G26	169LPG32	179HDG36	264CG10
127HBI11	169PG32	179PMTE17	264CA.....G14
128HBLSV.....I11	169PLM.....A39, A40	179PMTNS.....E17	264NTA.....F8
129HBI11	169PLMBJ.....A44	179PMTR.....E17	265AB.....F13
0136.....I14	169PLMX.....A40	179VLF19	265CG10
139HBI12	169PLS.....A50, A51	189PMTR.....E17	265CA.....G14
0142.....G25	169PLSX.....A51	0191.....I14	265NTA.....F8
0143.....J13	169PMTE15	0192.....J19	269CG10
0144.....J13	169PMTBH.....E15	0199.....G21	269CA.....G15
144FH10	169PMTL.....E15	207ACBH.....F14, J8	269HBI13
0145.....J13	169PMTNS.....E15	207PJ8	269TFF11
145FH10	169PMTNS-X-M.....E15	208-FSS-BPD.....M8	270AB.....F14
146HBLFSV.....I12	169PMTR.....E15	208PJ8	270CG11
149FH10	169PS.....G32	209PJ8	270CA.....G15
149F-X-MIJ21	169PTCNS.....E11	210PJ8	270NTA.....F9
149F-X-MIXH11	169VLF19	211PJ8	279HBI13
150FH11	170CG11	212PJ8	309PC39
151FH11	170CA.....G15	213PJ9	313GHC42
0152.....J13	170HDG36	215PN.....J9	316GHC42
0155.....J14	170PG33	215PNL.....J9	316PC40
155FH11	170PMTE16	216PJ9	318PC39
0158.....J14	170PMTNS.....E16	218B-BPDM6	322HBC39
159FH11	170VLF19	218PJ9	322PLPSPA33, A34
159F-X-MIJ21	171CG11	219PJ9	325GHC42
159F-X-MIXH12	171CA.....G15	0220.....G26, I7	325GHSV.....C42
0163.....J15	171HBI12	220PJ10	325HBC40
0164.....J13	171HDG36	222PJ10	326HBC40
164CG10	171PG33	222P-X-MIJ21	328HBC42
164CA.....G14	171PLM.....A40, A41	222P-X-MIX.....J13	329HBC41
164HDG35	171PLS.....A51	224.....I7	347PLP.....A30
164PG32	171PMTE16	225.....I7	362HBC41
164PLM.....A43	171PMTNS.....E16	226-BPD.....M8	362PLP.....A28
164PLP.....A7	171PTCNS.....E11	226RB-BPD.....M8	362PLPD.....A29
164PLS.....A53	171VLF19	228.....I7	362PLPDSP.....A32
164PMT.....E14	172CG11	229.....I7	362PLPSP.....A32
164PTC.....E11	172CA.....G15	230.....I8	362PTC.....E7
164VLF19	172HDG36	231.....I8	364HBC39
165CG10	172PG33	232.....I8	364PLP.....A28
165CA.....G14	172PLM.....A41, A42	233.....I8	364PTC.....E7
165HDG35	172PLS.....A52	237.....I8	365HBC39
165PLM.....A43	172PMTE16	238.....I8	365PLP.....A27, A28
165PLMBH.....A43	172PMTNS.....E16	244FH10	365PLPBH.....A29
165PLP.....A8	172PTCNS.....E11	244IFHDH14	365PTC.....E7
165PLS.....A52, A53	172VLF19	245IFHDH15	367-FH-BPD.....M7
165PMT.....E14	174-F-BPDM5	249FH10	368-FH-BPD.....M7
165PMTBH.....E14	176CG11	249IF.....H15	368PLP.....A23
165PTC.....E11	176CA.....G16	250IFHDH15	368PLPD.....A24
166FSVH12	177CG11	251IFHDH15	369PLP.....A17

369PLPBJ..... A25	639CA..... G16	0912..... J16	6300..... D8
369PLPBJB A25	639F H12	0913..... J16	6302..... C11
369PLPO A55	639PLM A44	0914..... J16	6304..... C10
369PLPSP A30	639PLP A33, E17	0915..... J16	6306..... C10
369PLPSPX A31	639PLS A53	0916..... J17	6307..... C13
369PLPTJ A26	640F H12	0917..... J17	6315..... C7
369PLPTJB A25	640QSF H18	0920..... J18	6316..... C7
369PLPX..... A18	640QSFCR H18	0921..... J16	6322..... C13
369PTCSP E8	0652..... L7	0922..... J16	6325..... C8
370HB C41	0653..... L7	0923..... J17	6326..... C13
370PLP A24	0655..... L7	0924..... J17	6340..... C11
370PTCR E7	0656..... L7	0927..... J17	6351..... C12
371PLP A22	0657..... L7	0928..... J17	6366..... C11
371PLPSP A31, A32	0660..... B33	0929..... J14	6380..... C13
371PTCSP E9	660FHD H12	0931..... I14	6382..... C12
372HB C41	0661..... B33	945TH-BPD M8	6383..... C12, C13
372PLP A21	661FHD H12	1163-60-BPD J24	6388..... C12
372PLPSP A31	664FHD H12	1163-61-BPD J24	6503..... C9, C10
372PTCSP E9	0670..... L10	1200P J10	6505..... C7
376PLPBJ..... A26	0671..... L10	1201P J11	6508..... C9
377PLP A21	0672..... L11	1202P J10	6509..... C8, C9
377PTC..... E8	0673..... L10	1203P J10	6521..... C8
379PLP A19	0674..... L11	1204P J11	6548..... C13
379PLPSP A31	0676..... L11	1295HB I11	6579..... C8
391P G30	0677..... L10	1495F H11	7810..... B24
391PSS..... G30	0682..... L11	1595F H12	7812..... B24
392P G30	682C G11	1695HB I12	7815..... B24
392PSS..... G30	682CA..... G16	1695PMH E21	7817..... B24
393P G30	682VL F19	1695VLV F19	7835..... B24
393PD..... G31	0683..... L11	1715PMH E21	7892..... B31
393PDSS G31	685HB I10	1725HB I12	7894..... B31
393PSS..... G30	685PMH E21	1725PMH E21	7982..... B34
394P G31	685VLV F18	1795HB I12	A613 E23
394PD..... G31	0690 03..... L8	2200P J10	A614 E23
394PDSS G31	0690 04..... L8	2200PDE J11	A623 E23
394PSS..... G31	0690 05..... L8	2201P J11	A624 E23
398P G31	0690 06..... L8	2202P J10	ACT-P-X-KIT K49
398PD..... G32	0690 08..... L9	2203P J10	ACT-SS-X-KIT..... K49
398PDSS G32	0690 09..... L9	2205P J11	ADJ-CB L12
398PSS..... G31	0690 10..... L9	2214P J11	AQRT C30
400-S-TIP L5	0690 11..... L9	2224P J11	AVC1..... H17
410..... L5	880AC..... H18	2225P J11	AVE1 H17
410-N..... L5	881AC..... H18	2491FHD H15	AVT3 H17
410-S..... L5	0900..... J18	3000 71 11..... M6	AVTS..... H17
410-SV..... L5	901GH J24	3000 71 11 05..... M6	AVTS4..... H18
411FF H14	0902..... J19	3100..... D6	AVTS6..... H18
411FS H14	0903..... J17	3110..... A35	AVU1..... H17
415-N..... L5	0904..... J18	3151..... A34	AVU2..... H17
415-S..... L5	0905..... J18	3330..... A35	AVU2BH..... H17
485F H9	0906..... J18	4202..... K58	AVUIFI..... H17
525-F-BPD M8	0907..... J18	4203..... K58	AVUR3 H17
0610..... L10	0908..... J17	4890..... B29	AVUS H18
0611..... L11	0909..... J17	4891..... B29	AVUS3 H18
0614..... L11	0910..... J16	4892..... B29	AVUS3BH H17
639C..... G11	0911..... J16	4895..... B29	AVUS4D..... H18

AVUSE.....	H17	FCM731.....	B11	PMCE.....	D12	SAE 060103 BA.....	G9
BG441-NBL.....	L6	FCMB731.....	B12	PMTCE.....	D12	SAE 060110.....	G8
BG442-SBL.....	L6	FCMI731.....	B11	Pneu-Cab.....	L14	SAE 060111.....	G8
BG443-NBL.....	L6	FCMK731.....	B12	PSB.....	L14	SAE 060115.....	G8
BG444-SBL.....	L6	FCMS731.....	B14	PSBJ708.....	B40	SAE 060201 BA.....	G10
BU.....	C22, C34	FCMSI731.....	B15	PSBJ731.....	B40	SAE 060202 BA.....	G10
BVC.....	K44	FCMSP731.....	B17	PSPE731.....	B40	SAE 060203 BA.....	G11
BVG4PLOCK.....	K53	FCMSPI731.....	B17	PSPJ731.....	B40	SAE 060401 BA.....	G10
BVGL.....	K51	FCPM832.....	B20	PTC-001RB.....	M6	SAE 060424 BA.....	G11
BVGL.....	K51	FE.....	C25, C34	PV607.....	K46	SAE 060425 BA.....	G11
C8UPMTB.....	E19	FF.....	C24	PV608.....	K46	SAE 100101 BA.....	F7
CAP.....	C24	GR.....	C35	PV609.....	K46	SAE 100102 BA.....	F8
Clip.....	A34	HPMTB.....	E19	PVMB-001.....	K46	SAE 100103 BA.....	F8
Copper Tubing.....	L14	HV104C.....	K63	RD.....	C23	SAE 100110.....	F7
CR-001.....	H18	HV104C-kit.....	K63	S8UPMTB.....	E19	SAE 100115.....	F7
CU.....	C24	JPMTB.....	E19	S32633-BPD.....	M5	SAE 100201 BA.....	F8
DC601.....	K66	LSR-Stand.....	L13	S75015-BPD.....	M5	SAE 100202 BA.....	F9
DC602.....	K67	LV91.....	F21	S75046-BPD.....	M5	SAE 100203 BA.....	F9
DC603.....	K67	MBVG.....	K55	SAE 010101.....	H8	SAE 100302 BA.....	F9
DC604.....	K67	MC.....	C19, C33	SAE 010102.....	H9	SAE 100401 BA.....	F8
DC606.....	K67	MCVC.....	C27	SAE 010103.....	H9	SAE 100424 BA.....	F9
DC607.....	K67	ME.....	C23, C33	SAE 010104.....	H8	SAE 100425 BA.....	F9
DCR601.....	K67	MES.....	C20	SAE 010105.....	H12	SAE 120101 BA.....	F13
ERHD.....	E13	MR.....	C34	SAE 010106.....	H12	SAE 120102 BA.....	F13
EU.....	C19, C33	MRS.....	C20	SAE 010107.....	H12	SAE 120103 BA.....	F13
F2PMTB.....	E19	MT.....	C34	SAE 010108.....	H7	SAE 120111.....	F13
F3HG.....	J13	MTS.....	C21	SAE 010109.....	H12	SAE 120115.....	F13
F8UPMTB.....	E19	MV200.....	K39	SAE 010110.....	H8	SAE 120201 BA.....	F13
FA.....	C21	MV308.....	B42	SAE 010111.....	H8	SAE 120202 BA.....	F14
FC.....	C22, C34	MV309.....	B42	SAE 010112.....	H12	SAE 120203 BA.....	F14
FC601.....	B36	MV608.....	K39	SAE 010113.....	H7	SAE 120302 BA.....	F14
FC602.....	B36	MV609.....	K39	SAE 010114.....	H7	SAE 120401 BA.....	F13
FC608.....	B36	MV708.....	K37	SAE 010165.....	H7	SAE 120424 BA.....	F14
FC701.....	B22	MV709.....	K37	SAE 010166.....	H7	SAE 120425 BA.....	F14
FC702.....	B22	MVV308.....	B42	SAE 010167.....	H7	SC.....	C30
FC705.....	B22	MVV309.....	B42	SAE 010201.....	H11	SPV104C-kit.....	K63
FC708.....	B22	NS.....	C35	SAE 010202.....	H10	ST.....	C24
FC731.....	B7	NV101F.....	K63	SAE 010203.....	H11	STX-P-1-125.....	K61
FC832.....	B19	NV102F.....	K63	SAE 010302.....	H11	STX-P-1-225.....	K61
FC836.....	B20	NV103F.....	K63	SAE 010401.....	H10	SV404P.....	F21
FC908.....	B38	NV104C.....	K63	SAE 010424.....	H11	TAF.....	C24
FCB832.....	B19	NV104CA.....	K63	SAE 010425.....	H10	TC-1000-BPD.....	M5
FCC731.....	B7	NV105C.....	K63	SAE 040101.....	H14	TC-1050-BPD.....	M5
FCCB731.....	B8	NV105CA.....	K63	SAE 040102.....	H14	TCB.....	C24
FCCI731.....	B7	NV106C.....	K64	SAE 040103.....	H14	TEB.....	C25
FCCS731.....	B14, B15	NV106CA.....	K64	SAE 040110.....	H14	TEU.....	C23
FCCSP731.....	B17	NV107P.....	K64	SAE 040202.....	H15	TFA.....	C24
FCCSPI731.....	B17	NV108P.....	K64	SAE 040203.....	H15	TMC.....	C22
FCI701.....	B22	NV109P.....	K64	SAE 040302.....	H15	TPL.....	C25
FCI702.....	B22	NV311P.....	G33, K64	SAE 040401.....	H14	TS.....	C30, C35
FCIC908.....	B38	NV312P.....	G33, K64	SAE 040424.....	H15	TSC.....	C26, D10
FCK701C.....	B9	OR.....	C35	SAE 040425.....	H15	TU.....	C19, C34
FCKC731.....	B8	PLMC.....	A44, D5, D11	SAE 040427.....	H15	UC.....	C21, C33
FCKCB731.....	B9	PLPHBF4.....	A7	SAE 060101 BA.....	G8	US5.....	H7
FCKCI731.....	B9	PLSC.....	A53, D11	SAE 060102 BA.....	G9	V203F.....	K66

V204F	K66	V633P	K26	W369PLPO	A55
V303C	K66	VAS	C16, K5, K42	W369PLPTJ	A26
V303CA	K66	VC	B27, C27	W369PLPX	A18
V304C	K66	VC-001	H18	W371PLP	A21, A22
V304CA	K66	VEU	C29, C15, K5, K41	W372PLP	A19, A20
V401P	K66	VFC	C29, C42, C15, K5, K42	W379PLP	A18, A19
V402P	K66	VFE	C28, C26, C14, K5, K41	WY	C20
V403P	K66	VMC	C29, C27, C15, K5, K41		
V404P	F21	VME	C14, C28, C43, K5, K41		
V404PH	F21	VP500CS	K28		
V405P	F21	VP500HP	K32		
V406P	K66	VP500P	K8		
V407P	K66	VP501P	K11		
V408NTA	F21	VP502CS	K28		
V409F	F21	VP502P	K13		
V410NTA	F21	VP502SS	K36		
V412F	F21	VP506HP	K33		
V500CS	K28	VP510P	K18		
V500CS-X-04	K28	VS68AB	F13		
V500CS-X-21	K29	VS68NTA	F8		
V500HP	K32	VS68PTCR	E10		
V500P	K8	VS176NTA	F8		
V500P-HB	K24	VS269AB	F14		
V500P-X-04	K9	VS269NTA	F9		
V500P-X-21	K9	VS271AB	F14		
V501P	K11	VS271NTA	F9		
V501P-X-04	K11	VS272AB	F14		
V501P-X-21	K11	VS272NTA	F9		
V501SS	K34	VS279AB	F14		
V502CS	K28	VS279NTA	F9		
V502CS-X-21	K29	VS368PTCR	E7		
V502P	K13	VS369PTCR	E7		
V502P-X-04	K13	VS371PTCR	E8		
V502P-X-ACT	K48	VS372PTCR	E8		
V502P-X-SUB	K49	VTEU	C30, K5, K43		
V502SS	K36	VUC	C14, C29, K5, K41		
V502SS-X-20	K36	VUCPB	C15, C43, K5, K42		
V502SS-X-21	K36	VV500P	K8		
V502SS-X-ACT	K48	VV501P	K11		
V502SS-X-SUB	K49	VV502P	K13		
V506CS	K30	VVP500P	K8		
V506HP	K33	VVP501P	K11		
V506P	K15	VVP502P	K13		
V509P	K16	W68LF	A14, A15		
V510P	K18	W68PLCK	B26		
V510P-X-04	K18	W68PLCKI	B26		
V510P-X-21	K18	W68PLP	A6		
V520P	K19	W68PLPSP	A22		
V533P	K21	W169PLP	A8		
V540P	K21	W169PLPNS	A8		
V590P	K23	W171PLP	A8		
V590P-X-04	K23	W172PLP	A9		
V591P	K23	W368PLP	A23		
V591P-X-04	K23	W369PLP	A16, A17		
V600P	K26	W369PLPBJ	A24		

Parker Safety Guide for Selecting and Using Hose, Tubing, Fittings, Connectors, Conductors, Valves and Related Accessories

Parker Publication No. 4400-B.1

WARNING: Failure or improper selection or improper use of hose, tubing, fittings, assemblies, valves, connectors, conductors or related accessories ("Products") can cause death, personal injury and property damage. Possible consequences of failure or improper selection or improper use of these Products include but are not limited to:

- Fittings thrown off at high speed.
- High velocity fluid discharge.
- Explosion or burning of the conveyed fluid.
- Electrocutation from high voltage electric powerlines.
- Contact with suddenly moving or falling objects that are controlled by the conveyed fluid.
- Injections by high-pressure fluid discharge.
- Dangerously whipping Hose.
- Tube or pipe burst.
- Weld joint fracture.
- Contact with conveyed fluids that may be hot, cold, toxic or otherwise injurious.
- Sparking or explosion caused by static electricity buildup or other sources of electricity.
- Sparking or explosion while spraying paint or flammable liquids.
- Injuries resulting from inhalation, ingestion or exposure to fluids.

Before selecting or using any of these Products, it is important that you read and follow the instructions below. No product from any division in Fluid Connector Group is approved for in-flight aerospace applications. For hoses and fittings used in in-flight aerospace applications, please contact Parker Aerospace Group

GENERAL INSTRUCTIONS

1.0 Scope: This safety guide provides instructions for selecting and using (including assembling, installing, and maintaining) these Products. For convenience, all rubber and/or thermoplastic products commonly called "hose" or "tubing" are called "Hose" in this safety guide. Metallic tube or pipe are called "tube". All assemblies made with Hose are called "Hose Assemblies". All assemblies made with Tube are called "Tube Assemblies". All products commonly called "fittings", "couplings" or "adapters" are called "Fittings". Valves are fluid system components that control the passage of fluid. Related accessories are ancillary devices that enhance or monitor performance including crimping, flaring, flanging, presetting, bending, cutting, deburring, swaging machines, sensors, tags, lockout handles, spring guards and associated tooling. This safety guide is a supplement to and is to be used with the specific Parker publications for the specific Hose, Fittings and Related Accessories that are being considered for use. Parker publications are available at www.parker.com. SAE J1273 (www.sae.org) and ISO 17165-2 (www.ansi.org) also provide recommended practices for hydraulic Hose Assemblies, and should be followed.

- 1.1 Fail-Safe:** Hose, Hose Assemblies, Tube, Tube Assemblies and Fittings can and do fail without warning for many reasons. Design all systems and equipment in a fail-safe mode, so that failure of the Hose, Hose Assembly, Tube, Tube Assembly or Fitting will not endanger persons or property.
- 1.2 Distribution:** Provide a copy of this safety guide to each person responsible for selecting or using Hose, Tube and Fitting products. Do not select or use Parker Hose, Tube or Fittings without thoroughly reading and understanding this safety guide as well as the specific Parker publications for the Products.
- 1.3 User Responsibility:** Due to the wide variety of operating conditions and applications for Hose, Tube and Fittings. Parker does not represent or warrant that any particular Hose, Tube or Fitting is suitable for any specific end use system. This safety guide does not analyze all technical parameters that must be considered in selecting a product. The user, through its own analysis and testing, is solely responsible for:
- Making the final selection of the Products.
 - Assuring that the user's requirements are met and that the application presents no health or safety hazards.
 - Following the safety guide for Related Accessories and being trained to operate Related Accessories.
 - Providing all appropriate health and safety warnings on the equipment on which the Products are used.
 - Assuring compliance with all applicable government and industry standards.
- 1.4 Additional Questions:** Call the appropriate Parker technical service department if you have any questions or require any additional information. See the Parker publication for the Products being considered or used, or call 1-800-CPARKER, or go to www.parker.com, for telephone numbers of the appropriate technical service department.

2.0 HOSE, TUBE AND FITTINGS SELECTION INSTRUCTIONS

2.1 Electrical Conductivity: Certain applications require that the Hose be nonconductive to prevent electrical current flow. Other applications require the Hose and the Fittings and the Hose/Fitting interface to be sufficiently conductive to drain off static electricity. Extreme care must be exercised when selecting Hose, Tube and Fittings for these or any other applications in which electrical conductivity or nonconductivity is a factor.

The electrical conductivity or nonconductivity of Hose, Tube and Fittings is dependent upon many factors and may be susceptible to change. These factors include but are not limited to the various materials used to make the Hose and the Fittings, Fitting finish (some Fitting finishes are electrically conductive while others are nonconductive), manufacturing methods (including moisture control), how the Fittings contact the Hose, age and amount of deterioration or damage or other changes, moisture content of the Hose at any particular time, and other factors.

The following are considerations for electrically nonconductive and conductive Hose. For other applications consult the individual catalog pages and the appropriate industry or regulatory standards for proper selection.

2.1.1 Electrically Nonconductive Hose: Certain applications require that the Hose be nonconductive to prevent electrical current flow or to maintain

electrical isolation. For applications that require Hose to be electrically nonconductive, including but not limited to applications near high voltage electric lines, only special nonconductive Hose can be used. The manufacturer of the equipment in which the nonconductive Hose is to be used must be consulted to be certain that the Hose, Tube and Fittings that are selected are proper for the application. Do not use any Parker Hose or Fittings for any such application requiring nonconductive Hose, including but not limited to applications near high voltage electric lines or dense magnetic fields, unless (i) the application is expressly approved in the Parker technical publication for the product, (ii) the Hose is marked "nonconductive", and (iii) the manufacturer of the equipment on which the Hose is to be used specifically approves the particular Parker Hose, Tube and Fittings for such use.

2.1.2 Electrically Conductive Hose: Parker manufactures special Hose for certain applications that require electrically conductive Hose. Parker manufactures special Hose for conveying paint in airless paint spraying applications. This Hose is labeled "Electrically Conductive Airless Paint Spray Hose" on its layline and packaging. This Hose must be properly connected to the appropriate Parker Fittings and properly grounded in order to dissipate dangerous static charge buildup, which occurs in all airless paint spraying applications. Do not use any other Hose for airless paint spraying, even if electrically conductive. Use of any other Hose or failure to properly connect the Hose can cause a fire or an explosion resulting in death, personal injury, and property damage. All hoses that convey fuels must be grounded. Parker manufactures a special Hose for certain compressed natural gas ("CNG") applications where static electricity buildup may occur. Parker CNG Hose assemblies comply with the requirements of ANSI/IAS NGV 4.2; CSA 12.52, "Hoses for Natural Gas Vehicles and Dispensing Systems" (www.ansi.org). This Hose is labeled "Electrically Conductive for CNG Use" on its layline and packaging. This Hose must be properly connected to the appropriate Parker Fittings and properly grounded in order to dissipate dangerous static charge buildup, which occurs in, for example, high velocity CNG dispensing or transfer. Do not use any other Hose for CNG applications where static charge buildup may occur, even if electrically conductive. Use of other Hoses in CNG applications or failure to properly connect or ground this Hose can cause a fire or an explosion resulting in death, personal injury, and property damage. Care must also be taken to protect against CNG permeation through the Hose wall. See section 2.6, Permeation, for more information. Parker CNG Hose is intended for dispenser and vehicle use within the specified temperature range. Parker CNG Hose should not be used in confined spaces or unventilated areas or areas exceeding the specified temperature range. Final assemblies must be tested for leaks. CNG Hose Assemblies should be tested on a monthly basis for conductivity per ANSI/IAS NGV 4.2; CSA 12.52. Parker manufactures special Hose for aerospace in-flight applications. Aerospace in-flight applications employing Hose to transmit fuel, lubricating fluids and hydraulic fluids require a special Hose with a conductive inner tube. This Hose for in-flight applications is available only from Parker's Stratoflex Products Division. Do not use any other Parker Hose for in-flight applications, even if electrically conductive. Use of other Hoses for in-flight applications or failure to properly connect or ground this Hose can cause a fire or an explosion resulting in death, personal injury and property damage. These Hose assemblies for in-flight applications must meet all applicable aerospace industry, aircraft engine and aircraft requirements.

2.2 Pressure: Hose, Tube and Fitting selection must be made so that the published maximum working pressure of the Hose, Tube and Fittings are equal to or greater than the maximum system pressure. The maximum working pressure of a Hose, or Tube Assembly is the lower of the respective published maximum working pressures of the Hose, Tube and the Fittings used. Surge pressures or peak transient pressures in the system must be below the published maximum working pressure for the Hose, Tube and Fitting. Surge pressures and peak pressures can usually only be determined by sensitive electrical instrumentation that measures and indicates pressures at millisecond intervals. Mechanical pressure gauges indicate only average pressures and cannot be used to determine surge pressures or peak transient pressures. Published burst pressure ratings for Hose is for manufacturing test purposes only and is no indication that the Product can be used in applications at the burst pressure or otherwise above the published maximum recommended working pressure.

- 2.3 Suction:** Hoses used for suction applications must be selected to insure that the Hose will withstand the vacuum and pressure of the system. Improperly selected Hose may collapse in suction application.
- 2.4 Temperature:** Be certain that fluid and ambient temperatures, both steady and transient, do not exceed the limitations of the Hose, Tube, Fitting and Seals. Temperatures below and above the recommended limit can degrade Hose, Tube, Fittings and Seals to a point where a failure may occur and release fluid. Tube and Fittings performances are normally degraded at elevated temperature. Material compatibility can also change at temperatures outside of the rated range. Properly insulate and protect the Hose Assembly when routing near hot objects (e.g. manifolds). Do not use any Hose in any application where failure of the Hose could result in the conveyed fluids (or vapors or mist from the conveyed fluids) contacting any open flame, molten metal, or other potential fire ignition source that could cause burning or explosion of the conveyed fluids or vapors.
- 2.5 Fluid Compatibility:** Hose, and Tube Assembly selection must assure compatibility of the Hose tube, cover, reinforcement, Tube, Plating and Seals with the fluid media used. See the fluid compatibility chart in the Parker publication for the product being considered or used. This information is offered only as a guide. Actual service life can only be determined by the end user by testing under all extreme conditions and other analysis. Hose, and Tube that is chemically compatible with a particular fluid must be assembled using Fittings and adapters containing likewise compatible seals. Flange or flare processes can change Tube material properties that may not be compatible with certain requirements such as NACE
- 2.6 Permeation:** Permeation (that is, seepage through the Hose or Seal) will occur from inside the Hose or Fitting to outside when Hose or Fitting is used with gases, liquid and gas fuels, and refrigerants (including but not limited to such materials as helium, diesel fuel, gasoline, natural gas, or LPG). This permeation may result in high concentrations of vapors which are potentially flammable, explosive, or toxic, and in loss of fluid. Dangerous explosions, fires, and other hazards can result when using the wrong Hose for such applications. The system designer must take into account the fact that this permeation will take place and must not use Hose or Fitting if this permeation could be hazardous. The system designer must take into account all legal, government, insurance, or any other special regulations which govern the use of fuels and refrigerants. Never use a Hose or Fitting even though the fluid compatibility is acceptable without considering the potential hazardous effects that can result from permeation through the Hose or Tube Assembly. Permeation of moisture from outside the Hose or Fitting to inside the Hose or Fitting will also occur in Hose or Tube assemblies, regardless of internal pressure. If this moisture permeation would have detrimental effects (particularly, but not limited to refrigeration and air conditioning systems), incorporation of sufficient drying capacity in the system or other appropriate system safeguards should be selected and used. The sudden pressure release of highly pressurized gas could also result in Explosive Decompression failure of permeated Seals and Hoses.
- 2.7 Size:** Transmission of power by means of pressurized fluid varies with pressure and rate of flow. The size of the components must be adequate to keep pressure losses to a minimum and avoid damage due to heat generation or excessive fluid velocity.
- 2.8 Routing:** Attention must be given to optimum routing to minimize inherent problems (kinking or flow restriction due to Hose collapse, twisting of the Hose, proximity to hot objects or heat sources). For additional routing recommendations see SAE J1273 and ISO 17165-2. Hose Assemblies have a finite life and should be installed in a manner that allows for ease of inspection and future replacement. Hose because of its relative short life, should not be used in residential and commercial buildings inside of inaccessible walls or floors, unless specifically allowed in the product literature. Always review all product literature for proper installation and routing instructions.
- 2.9 Environment:** Care must be taken to insure that the Hose, Tube and Fittings are either compatible with or protected from the environment (that is, surrounding conditions) to which they are exposed. Environmental conditions including but not limited to ultraviolet radiation, sunlight, heat, ozone, moisture, water, salt water, chemicals and air pollutants can cause degradation and premature failure.
- 2.10 Mechanical Loads:** External forces can significantly reduce Hose, Tube and Fitting life or cause failure. Mechanical loads which must be considered include excessive flexing, twist, kinking, tensile or side loads, bend radius, and vibration. Use of swivel type Fittings or adapters may be required to insure no twist is put into the Hose. Use of proper Hose or Tube clamps may also be required to reduce external mechanical loads. Unusual applications may require special testing prior to Hose selection.
- 2.11 Physical Damage:** Care must be taken to protect Hose from wear, snagging, kinking, bending smaller than minimum bend radius and cutting, any of which can cause premature Hose failure. Any Hose that has been kinked or bent to a radius smaller than the minimum bend radius, and any Hose that has been cut or is cracked or is otherwise damaged should be removed and discarded. Fittings with damages such as scratches on sealing surfaces and deformation should be replaced.
- 2.12 Proper End Fitting:** See instructions 3.2 through 3.5. These recommendations may be substantiated by testing to industry standards such as SAE J517 for hydraulic applications, or MIL-A-5070, AS1339, or AS3517 for Hoses from Parker's Stratoflex Products Division for aerospace applications.
- 2.13 Length:** When determining the proper Hose or Tube length of an assembly, be aware of Hose length change due to pressure, Tube length change due to thermal expansion or contraction, and Hose or Tube and machine tolerances and movement must be considered. When routing short hose assemblies, it is recommended that the minimum free hose length is always used. Consult the hose manufacturer for their minimum free hose length recommendations. Hose assemblies should be installed in such a way that any motion or flexing occurs within the same plane.
- 2.14 Specifications and Standards:** When selecting Hose, Tube and Fittings, government, industry, and Parker specifications and recommendations must be reviewed and followed as applicable.
- 2.15 Hose Cleanliness:** Hose and Tube components may vary in cleanliness levels. Care must be taken to insure that the Hose and Tube Assembly selected has an adequate level of cleanliness for the application.
- 2.16 Fire Resistant Fluids:** Some fire resistant fluids that are to be conveyed by Hose or Tube require use of the same type of Hose or Tube as used with petroleum base fluids. Some such fluids require a special Hose, Tube, Fitting and Seal, while a few fluids will not work with any Hose at all. See instructions 2.5 and 1.5. The wrong Hose, Tube, Fitting or Seal may fail after a very short service. In addition, all liquids but pure water may burn fiercely under certain conditions, and even pure water leakage may be hazardous.
- 2.17 Radiant Heat:** Hose and Seals can be heated to destruction without contact by such nearby items as hot manifolds or molten metal. The same heat source may then initiate a fire. This can occur despite the presence of cool air around the Hose or Seal. Performance of Tube and Fitting subjected to the heat could be degraded.
- 2.18 Welding or Brazing:** When using a torch or arc welder in close proximity to hydraulic lines, the hydraulic lines should be removed or shielded with appropriate fire resistant materials. Flame or weld spatter could burn through the Hose or Seal and possibly ignite escaping fluid resulting in a catastrophic failure. Heating of plated parts, including Hose Fittings and adapters, above 450°F (232°C) such as during welding, brazing or soldering may emit deadly gases. Any elastomer seal on fittings shall be removed prior to welding or brazing, any metallic surfaces shall be protected after brazing or welding when necessary. Welding and brazing filler material shall be compatible with the Tube and Fitting that are joined.
- 2.19 Atomic Radiation:** Atomic radiation affects all materials used in Hose and Tube assemblies. Since the long-term effects may be unknown, do not expose Hose or Tube assemblies to atomic radiation. Nuclear applications may require special Tube and Fittings.
- 2.20 Aerospace Applications:** The only Hose, Tube and Fittings that may be used for in-flight aerospace applications are those available from Parker's Stratoflex Products Division. Do not use any other Hose or Fittings for in-flight applications. Do not use any Hose or Fittings from Parker's Stratoflex Products Division with any other Hose or Fittings, unless expressly approved in writing by the engineering manager or chief engineer of Stratoflex Products Division and verified by the user's own testing and inspection to aerospace industry standards.
- 2.21 Unlocking Couplings:** Ball locking couplings or other Fittings with quick disconnect ability can unintentionally disconnect if they are dragged over obstructions, or if the sleeve or other disconnect member, is bumped or moved enough to cause disconnect. Threaded Fittings should be considered where there is a potential for accidental uncoupling.
- 3.0 HOSE AND FITTINGS ASSEMBLY AND INSTALLATION INSTRUCTIONS**
- 3.1 Component Inspection:** Prior to assembly, a careful examination of the Hose and Fittings must be performed. All components must be checked for correct style, size, catalog number, and length. The Hose must be examined for cleanliness, obstructions, blisters, cover looseness, kinks, cracks, cuts or any other visible defects. Inspect the Fitting and sealing surfaces for burrs, nicks, corrosion or other imperfections. Do NOT use any component that displays any signs of nonconformance.
- 3.2 Hose and Fitting Assembly:** Do not assemble a Parker Fitting on a Parker Hose that is not specifically listed by Parker for that Fitting, unless authorized in writing by the engineering manager or chief engineer of the appropriate Parker division. Do not assemble a Parker Fitting on another manufacturer's Hose or a Parker Hose on another manufacturer's Fitting unless (i) the engineering manager or chief engineer of the appropriate Parker division approves the Assembly in writing or that combination is expressly approved in the appropriate Parker literature for the specific Parker product, and (ii) the user verifies the Assembly and the application through analysis and testing. For Parker Hose that does not specify a Parker Fitting, the user is solely responsible for the selection of the proper Fitting and Hose Assembly procedures. See instruction 1.4. To prevent the possibility of problems such as leakage at the Fitting or system contamination, it is important to completely remove all debris from the cutting operation before installation of the Fittings. The Parker published instructions must be followed for assembling the Fittings on the Hose. These instructions are provided in the Parker Fitting catalog for the specific Parker Fitting being used, or by calling 1-800-CPARKER, or at www.parker.com.
- 3.3 Related Accessories:** Do not crimp or swage any Parker Hose or Fitting with anything but the listed swage or crimp machine and dies in accordance with Parker published instructions. Do not crimp or swage another manufacturer's Fitting with a Parker crimp or swage die unless authorized in writing by the engineering manager or chief engineer of the appropriate Parker division.
- 3.4 Parts:** Do not use any Parker Fitting part (including but not limited to socket, shell, nipple, or insert) except with the correct Parker mating parts, in accordance with Parker published instructions, unless authorized in writing by the engineering manager or chief engineer of the appropriate Parker division.
- 3.5 Field Attachable/Permanent:** Do not reuse any field attachable Hose Fitting that has blown or pulled off a Hose. Do not reuse a Parker permanent Hose Fitting (crimped or swaged) or any part thereof. Complete Hose Assemblies may only be reused after proper inspection under section 4.0. Do not assemble Fittings to any previously used hydraulic Hose that was in service, for use in a fluid power application.
- 3.6 Pre-Installation Inspection:** Prior to installation, a careful examination of the Hose Assembly must be performed. Inspect the Hose Assembly for any damage or defects. DO NOT use any Hose Assembly that displays any signs of nonconformance.
- 3.7 Minimum Bend Radius:** Installation of a Hose at less than the minimum listed bend radius may significantly reduce the Hose life. Particular attention must be given to preclude sharp bending at the Hose to Fitting juncture. Any bending during installation at less than the minimum bend radius must be avoided. If any Hose is kinked during installation, the Hose must be discarded.
- 3.8 Twist Angle and Orientation:** Hose Assembly installation must be such that relative motion of machine components does not produce twisting.
- 3.9 Securement:** In many applications, it may be necessary to restrain, protect, or guide the Hose to protect it from damage by unnecessary flexing, pressure surges, and contact with other mechanical components. Care must be taken to insure such restraints do not introduce additional stress or wear points.
- 3.10 Proper Connection of Ports:** Proper physical installation of the Hose Assembly

requires a correctly installed port connection insuring that no twist or torque is transferred to the Hose when the Fittings are being tightened or otherwise during use.

- 3.11 **External Damage:** Proper installation is not complete without insuring that tensile loads, side loads, kinking, flattening, potential abrasion, thread damage or damage to sealing surfaces are corrected or eliminated. See instruction 2.10.
- 3.12 **System Checkout:** All air entrapment must be eliminated and the system pressurized to the maximum system pressure (at or below the Hose maximum working pressure) and checked for proper function and freedom from leaks. Personnel must stay out of potential hazardous areas while testing and using.
- 3.13 **Routing:** The Hose Assembly should be routed in such a manner so if a failure does occur, the escaping media will not cause personal injury or property damage. In addition, if fluid media comes in contact with hot surfaces, open flame or sparks, a fire or explosion may occur. See section 2.4.
- 3.14 **Ground Fault Equipment Protection Devices (GFEPDs):** WARNING! Fire and Shock Hazard. To minimize the danger of fire if the heating cable of a Multitube bundle is damaged or improperly installed, use a Ground Fault Equipment Protection Device. Electrical fault currents may be insufficient to trip a conventional circuit breaker. For ground fault protection, the IEEE 515: (www.ansi.org) standard for heating cables recommends the use of GFEPDs with a nominal 30 milliampere trip level for "piping systems in classified areas, those areas requiring a high degree of maintenance, or which may be exposed to physical abuse or corrosive atmospheres".

4.0 TUBE AND FITTINGS ASSEMBLY AND INSTALLATION INSTRUCTIONS

- 4.1 **Component Inspection:** Prior to assembly, a careful examination of the Tube and Fittings must be performed. All components must be checked for correct style, size, material, seal, and length. Inspect the Fitting and sealing surfaces for burrs, nicks, corrosion, missing seal or other imperfections. Do NOT use any component that displays any signs of nonconformance.
- 4.2 **Tube and Fitting Assembly:** Do not assemble a Parker Fitting with a Tube that is not specifically listed by Parker for that Fitting, unless authorized in writing by the engineering manager or chief engineer of the appropriate Parker division. The Tube must meet the requirements specified to the Fitting. The Parker published instructions must be followed for assembling the Fittings to a Tube. These instructions are provided in the Parker Fitting catalog for the specific Parker Fitting being used, or by calling 1-800-CPARKER, or at www.parker.com.
- 4.3 **Related Accessories:** Do not preset or flange Parker Fitting components using another manufacturer's equipment or procedures unless authorized in writing by the engineering manager or chief engineer of the appropriate Parker division. Tube, Fitting component and tooling must be checked for correct style, size and material. Operation and maintenance of Related Accessories must be in accordance with the operation manual for the designated Accessory.
- 4.4 **Securement:** In many applications, it may be necessary to restrain, protect, or guide the Tube to protect it from damage by unnecessary flexing, pressure surges, vibration, and contact with other mechanical components. Care must be taken to insure such restraints do not introduce additional stress or wear points.
- 4.5 **Proper Connection of Ports:** Proper physical installation of the Tube Assembly requires a correctly installed port connection insuring that no torque is transferred to the Tube when the Fittings are being tightened or otherwise during use.
- 4.6 **External Damage:** Proper installation is not complete without insuring that tensile loads, side loads, flattening, potential abrasion, thread damage or damage to sealing surfaces are corrected or eliminated. See instruction 2.10.
- 4.7 **System Checkout:** All air entrapment must be eliminated and the system pressurized to the maximum system pressure (at or below the Tube Assembly maximum working pressure) and checked for proper function and freedom from leaks. Personnel must stay out of potential hazardous areas while testing and using.
- 4.8 **Routing:** The Tube Assembly should be routed in such a manner so if a failure does occur, the escaping media will not cause personal injury or property damage. In addition, if fluid media comes in contact with hot surfaces, open flame or sparks, a fire or explosion may occur. See section 2.4.

5.0 HOSE AND FITTING MAINTENANCE AND REPLACEMENT INSTRUCTIONS

- 5.1 Even with proper selection and installation, Hose life may be significantly reduced without a continuing maintenance program. The severity of the application, risk potential from a possible Hose failure, and experience with any Hose failures in the application or in similar applications should determine the frequency of the inspection and the replacement for the Products so that Products are replaced before any failure occurs. Certain products require maintenance and inspection per industry requirements. Failure to adhere to these requirements may lead to premature failure. A maintenance program must be established and followed by the user and, at minimum, must include instructions 5.2 through 5.7
- 5.2 **Visual Inspection Hose/Fitting:** Any of the following conditions require immediate shut down and replacement of the Hose Assembly:
- Fitting slippage on Hose;
 - Damaged, cracked, cut or abraded cover (any reinforcement exposed);
 - Hard, stiff, heat cracked, or charred Hose;
 - Cracked, damaged, or badly corroded Fittings;
 - Leaks at Fitting or in Hose;
 - Kinked, crushed, flattened or twisted Hose; and
 - Blistered, soft, degraded, or loose cover.
- 5.3 **Visual Inspection All Other:** The following items must be tightened, repaired, corrected or replaced as required:
- Leaking port conditions;
 - Excess dirt buildup;
 - Worn clamps, guards or shields; and
 - System fluid level, fluid type, and any air entrapment.
- 5.4 **Functional Test:** Operate the system at maximum operating pressure and check for possible malfunctions and leaks. Personnel must avoid potential hazardous areas while testing and using the system. See section 2.2.
- 5.5 **Replacement Intervals:** Hose assemblies and elastomeric seals used on Hose Fittings and adapters will eventually age, harden, wear and deteriorate under thermal cycling and compression set. Hose Assemblies and elastomeric seals

should be inspected and replaced at specific replacement intervals, based on previous service life, government or industry recommendations, or when failures could result in unacceptable downtime, damage, or injury risk. See section 1.2. Hose and Fittings may be subjected to internal mechanical and/or chemical wear from the conveying fluid and may fail without warning. The user must determine the product life under such circumstances by testing. Also see section 2.5.

- 5.6 **Hose Inspection and Failure:** Hydraulic power is accomplished by utilizing high pressure fluids to transfer energy and do work. Hoses, Fittings and Hose Assemblies all contribute to this by transmitting fluids at high pressures. Fluids under pressure can be dangerous and potentially lethal and, therefore, extreme caution must be exercised when working with fluids under pressure and handling the Hoses transporting the fluids. From time to time, Hose Assemblies will fail if they are not replaced at proper time intervals. Usually these failures are the result of some form of misapplication, abuse, wear or failure to perform proper maintenance. When Hoses fail, generally the high pressure fluids inside escape in a stream which may or may not be visible to the user. Under no circumstances should the user attempt to locate the leak by "feeling" with their hands or any other part of their body. High pressure fluids can and will penetrate the skin and cause severe tissue damage and possibly loss of limb. Even seemingly minor hydraulic fluid injection injuries must be treated immediately by a physician with knowledge of the tissue damaging properties of hydraulic fluid. If a Hose failure occurs, immediately shut down the equipment and leave the area until pressure has been completely released from the Hose Assembly. Simply shutting down the hydraulic pump may or may not eliminate the pressure in the Hose Assembly. Many times check valves, etc., are employed in a system and can cause pressure to remain in a Hose Assembly even when pumps or equipment are not operating. Tiny holes in the Hose, commonly known as pinholes, can eject small, dangerously powerful but hard to see streams of hydraulic fluid. It may take several minutes or even hours for the pressure to be relieved so that the Hose Assembly may be examined safely. Once the pressure has been reduced to zero, the Hose Assembly may be taken off the equipment and examined. It must always be replaced if a failure has occurred. Never attempt to patch or repair a Hose Assembly that has failed. Consult the nearest Parker distributor or the appropriate Parker division for Hose Assembly replacement information. Never touch or examine a failed Hose Assembly unless it is obvious that the Hose no longer contains fluid under pressure. The high pressure fluid is extremely dangerous and can cause serious and potentially fatal injury.

- 5.7 **Elastomeric seals:** Elastomeric seals will eventually age, harden, wear and deteriorate under thermal cycling and compression set. Elastomeric seals should be inspected and replaced.
- 5.8 **Refrigerant gases:** Special care should be taken when working with refrigeration systems. Sudden escape of refrigerant gases can cause blindness if the escaping gases contact the eye and can cause freezing or other severe injuries if it contacts any other portion of the body.
- 5.9 **Compressed natural gas (CNG):** Parker CNG Hose Assemblies should be tested after installation and before use, and at least on a monthly basis per instructions provided on the Hose Assembly tag. The recommended procedure is to pressurize the Hose and check for leaks and to visually inspect the Hose for damage and to perform an electrical resistance test. Caution: Matches, candles, open flame or other sources of ignition shall not be used for Hose inspection. Leak check solutions should be rinsed off after use.

6.0 HOSE STORAGE

- 6.1 **Age Control:** Hose and Hose Assemblies must be stored in a manner that facilitates age control and first-in and first-out usage based on manufacturing date of the Hose and Hose Assemblies. Unless otherwise specified by the manufacturer or defined by local laws and regulations:
- 6.1.1 The shelf life of rubber hose in bulk form or hose made from two or more materials is 28 quarters (7 years) from the date of manufacture, with an extension of 12 quarters (3 years), if stored in accordance with ISO 22303;
- 6.1.2 The shelf life of thermoplastic and polytetrafluoroethylene hose is considered to be unlimited;
- 6.1.3 Hose assemblies that pass visual inspection and proof test shall not be stored for longer than 2 years.
- 6.1.4 **Storage:** Stored Hose and Hose Assemblies must not be subjected to damage that could reduce their expected service life and must be placed in a cool, dark and dry area with the ends capped. Stored Hose and Hose Assemblies must not be exposed to temperature extremes, ozone, oils, corrosive liquids or fumes, solvents, high humidity, rodents, insects, ultraviolet light, electromagnetic fields or radioactive materials.

PARKER-HANNIFIN CORPORATION OFFER OF SALE

1. **Definitions.** As used herein, the following terms have the meanings indicated.

Buyer:	means any customer receiving a Quote for Products from Seller.
Goods:	means any tangible part, system or component to be supplied by the Seller.
Products:	means the Goods, Services and/or Software as described in a Quote provided by the Seller.
Quote:	means the offer or proposal made by Seller to Buyer for the supply of Products.
Seller:	means Parker-Hannifin Corporation, including all divisions and businesses thereof.
Services:	means any services to be supplied by the Seller.
Software:	means any software related to the Products, whether embedded or separately downloaded.
Terms:	means the terms and conditions of this Offer of Sale or any newer version of the same as published by Seller electronically at www.parker.com/saleterms .

2. **Terms.** All sales of Products by Seller are contingent upon, and will be governed by, these Terms and, these Terms are incorporated into any Quote provided by Seller to any Buyer. Buyer's order for any Products whether communicated to Seller verbally, in writing, by electronic data interface or other electronic commerce, shall constitute acceptance of these Terms. Seller objects to any contrary or additional terms or conditions of Buyer. Reference in Seller's order acknowledgement to Buyer's purchase order or purchase order number shall in no way constitute an acceptance of any of Buyer's terms of purchase. No modification to these Terms will be binding on Seller unless agreed to in writing and signed by an authorized representative of Seller.
3. **Price; Payment.** The Products set forth in Seller's Quote are offered for sale at the prices indicated in Seller's Quote. Unless otherwise specifically stated in Seller's Quote, prices are valid for thirty (30) days and do not include any sales, use, or other taxes or duties. Seller reserves the right to modify prices at any time to adjust for any raw material price fluctuations. Unless otherwise specified by Seller, all prices are F.C.A. Seller's facility (INCOTERMS 2010). All sales are contingent upon credit approval and payment for all purchases is due thirty (30) days from the date of invoice (or such date as may be specified in the Quote). Unpaid invoices beyond the specified payment date incur interest at the rate of 1.5% per month or the maximum allowable rate under applicable law.
4. **Shipment; Delivery; Title and Risk of Loss.** All delivery dates are approximate. Seller is not responsible for damages resulting from any delay. Regardless of the manner of shipment, delivery occurs and title and risk of loss or damage pass to Buyer, upon placement of the Products with the shipment carrier at Seller's facility. Unless otherwise agreed, Seller may exercise its judgment in choosing the carrier and means of delivery. No deferment of shipment at Buyers' request beyond the respective indicated shipping date will be made except on terms that will indemnify, defend and hold Seller harmless against all loss and additional expense. Buyer shall be responsible for any additional shipping charges incurred by Seller due to Buyer's acts or omissions.
5. **Warranty.** The warranty related to the Products is as follows: (i) Goods are warranted against defects in material or workmanship for a period of twelve (12) months from the date of delivery or 2,000 hours of use, whichever occurs first; (ii) Services shall be performed in accordance with generally accepted practices and using the degree of care and skill that is ordinarily exercised and customary in the field to which the Services pertain and are warranted for a period of six (6) months from the completion of the Services by Seller; and (iii) Software is only warranted to perform in accordance with applicable specifications provided by Seller to Buyer for ninety (90) days from the date of delivery or, when downloaded by a Buyer or end-user, from the date of the initial download. All prices are based upon the exclusive limited warranty stated above, and upon the following disclaimer:

DISCLAIMER OF WARRANTY: THIS WARRANTY IS THE SOLE AND ENTIRE WARRANTY PERTAINING TO PRODUCTS. SELLER DISCLAIMS ALL OTHER WARRANTIES, EXPRESS AND IMPLIED, INCLUDING DESIGN, NONINFRINGEMENT, MERCHANTABILITY, AND FITNESS FOR A PARTICULAR PURPOSE. SELLER DOES NOT WARRANT THAT THE SOFTWARE IS ERROR-FREE OR FAULT-TOLERANT, OR THAT

BUYER'S USE THEREOF WILL BE SECURE OR UNINTERRUPTED. BUYER AGREES AND ACKNOWLEDGES THAT UNLESS OTHERWISE AUTHORIZED IN WRITING BY SELLER THE SOFTWARE SHALL NOT BE USED IN CONNECTION WITH HAZARDOUS OR HIGH RISK ACTIVITIES OR ENVIRONMENTS. EXCEPT AS EXPRESSLY STATED HEREIN, ALL PRODUCTS ARE PROVIDED "AS IS".

6. **Claims; Commencement of Actions.** Buyer shall promptly inspect all Products upon receipt. No claims for shortages will be allowed unless reported to the Seller within ten (10) days of delivery. Buyer shall notify Seller of any alleged breach of warranty within thirty (30) days after the date the non-conformance is or should have been discovered by Buyer. Any claim or action against Seller based upon breach of contract or any other theory, including tort, negligence, or otherwise must be commenced within twelve (12) months from the date of the alleged breach or other alleged event, without regard to the date of discovery.
7. **LIMITATION OF LIABILITY.** IN THE EVENT OF A BREACH OF WARRANTY, SELLER WILL, AT ITS OPTION, REPAIR OR REPLACE THE NON-CONFORMING PRODUCT, RE-PERFORM THE SERVICES, OR REFUND THE PURCHASE PRICE PAID WITHIN A REASONABLE PERIOD OF TIME. **IN NO EVENT IS SELLER LIABLE FOR ANY SPECIAL, INDIRECT, INCIDENTAL OR CONSEQUENTIAL DAMAGES ARISING OUT OF, OR AS THE RESULT OF, THE SALE, DELIVERY, NON- DELIVERY, SERVICING, NON-COMPLETION OF SERVICES, USE, LOSS OF USE OF, OR INABILITY TO USE THE PRODUCTS OR ANY PART THEREOF, LOSS OF DATA, IDENTITY, PRIVACY, OR CONFIDENTIALITY, OR FOR ANY CHARGES OR EXPENSES OF ANY NATURE INCURRED WITHOUT SELLER'S WRITTEN CONSENT, WHETHER BASED IN CONTRACT, TORT OR OTHER LEGAL THEORY. IN NO EVENT SHALL SELLER'S LIABILITY UNDER ANY CLAIM MADE BY BUYER EXCEED THE PURCHASE PRICE PAID FOR THE PRODUCTS.**
8. **Loss to Buyer's Property.** Any designs, tools, patterns, materials, drawings, confidential information or equipment furnished by Buyer or any other items which are or become Buyer's property, will be considered obsolete and may be destroyed by Seller after two (2) consecutive years have elapsed without Buyer ordering the Products manufactured using such property. Seller shall not be responsible for any loss or damage to such property while it is in Seller's possession or control.
9. **Special Tooling.** Special Tooling includes but is not limited to tooling, jigs, fixtures and associated manufacturing equipment acquired or necessary to manufacture Products. A tooling charge may be imposed for any Special Tooling. Such Special Tooling shall be and remain Seller's property notwithstanding payment of any charges by Buyer. In no event will Buyer acquire any interest in Special Tooling belonging to Seller that is utilized in the manufacture of the Products, even if such Special Tooling has been specially converted or adapted for such manufacture and notwithstanding any charges paid by Buyer. Unless otherwise agreed, Seller has the right to alter, discard or otherwise dispose of any Special Tooling or other property in its sole discretion at any time.
10. **Security Interest.** To secure payment of all sums due, Seller retains a security interest in all Products delivered to Buyer and, Buyer's acceptance of these Terms is deemed to be a Security Agreement under the Uniform Commercial Code. Buyer authorizes Seller as its attorney to execute and file on Buyer's behalf all documents Seller deems necessary to perfect its security interest.
11. **User Responsibility.** The Buyer through its own analysis and testing, is solely responsible for making the final selection of the Products and assuring that all performance, endurance, maintenance, safety and warning requirements of the application of the Products are met. The Buyer must analyze all aspects of the application and follow applicable industry standards, specifications, and other technical information provided with the Product. If Seller provides Product options based upon data or specifications provided by the Buyer, the Buyer is responsible for determining that such data and specifications are suitable and sufficient for all applications and reasonably foreseeable uses of the Products. In the event the Buyer is not the end-user, Buyer will ensure such end-user complies with this paragraph.
12. **Use of Products, Indemnity by Buyer.** Buyer shall comply with all instructions, guides and specifications provided by Seller with the Products. Unauthorized Uses. If Buyer uses or resells the Products for any uses prohibited in Seller's instructions, guides or specifications, or Buyer otherwise fails to comply with Seller's instructions, guides and specifications, Buyer acknowledges that any such use, resale, or non-

05/17



compliance is at Buyer's sole risk. Buyer shall indemnify, defend, and hold Seller harmless from any losses, claims, liabilities, damages, lawsuits, judgments and costs (including attorney fees and defense costs), whether for personal injury, property damage, intellectual property infringement or any other claim, brought by or incurred by Buyer, Buyer's employees, or any other person, arising out of: (a) improper selection, application, design, specification or other misuse of Products provided by Seller; (b) any act or omission, negligent or otherwise, of Buyer; (c) Seller's use of patterns, tooling, equipment, plans, drawings, designs or specifications or other information or things furnished by Buyer; (d) damage to the Products from an external cause, repair or attempted repair by anyone other than Seller, failure to follow instructions, guides and specifications provided by Seller, use with goods not provided by Seller, or opening, modifying, deconstructing or tampering with the Products for any reason; or (e) Buyer's failure to comply with these Terms. Seller shall not indemnify Buyer under any circumstance except as otherwise provided in these Terms.

- 13. Cancellations and Changes.** Buyer may not cancel or modify any order for any reason, except with Seller's written consent and upon terms that will indemnify, defend and hold Seller harmless against all direct, incidental and consequential loss or damage. Seller, at any time, may change Product features, specifications, designs and availability.
- 14. Limitation on Assignment.** Buyer may not assign its rights or obligations without the prior written consent of Seller.
- 15. Force Majeure.** Seller does not assume the risk and is not liable for delay or failure to perform any of Seller's obligations by reason of events or circumstances beyond its reasonable control ("Events of Force Majeure"). Events of Force Majeure shall include without limitation: accidents, strikes or labor disputes, acts of any government or government agency, acts of nature, delays or failures in delivery from carriers or suppliers, shortages of materials, or any other cause beyond Seller's reasonable control.
- 16. Waiver and Severability.** Failure to enforce any provision of these Terms will not invalidate that provision; nor will any such failure prejudice Seller's right to enforce that provision in the future. Invalidation of any provision of these Terms by legislation or other rule of law shall not invalidate any other provision herein and, the remaining provisions will remain in full force and effect.
- 17. Termination.** Seller may terminate any agreement governed by or arising from these Terms for any reason and at any time by giving Buyer thirty (30) days prior written notice. Seller may immediately terminate, in writing, if Buyer: (a) breaches any provision of these Terms (b) appoints a trustee, receiver or custodian for all or any part of Buyer's property (c) files a petition for relief in bankruptcy on its own behalf, or one if filed by a third party (d) makes an assignment for the benefit of creditors; or (e) dissolves its business or liquidates all or a majority of its assets.
- 18. Ownership of Software.** Seller retains ownership of all Software supplied to Buyer hereunder. In no event shall Buyer obtain any greater right in and to the Software than a right in the nature of a license limited to the use thereof and subject to compliance with any other terms provided with the Software.
- 19. Indemnity for Infringement of Intellectual Property Rights.** Seller is not liable for infringement of any patents, trademarks, copyrights, trade dress, trade secrets or similar rights ("Intellectual Property Rights") except as provided in this Section. Seller will defend at its expense and will pay the cost of any settlement or damages awarded in an action brought against Buyer based on a third party claim that one or more of the Products sold hereunder infringes the Intellectual Property Rights of a third party in the country of delivery of the Products by the Seller to the Buyer. Seller's obligation to defend and indemnify Buyer is contingent on Buyer notifying Seller within ten (10) days after Buyer becomes aware of any such claim, and Seller having sole control over the defense of the claim including all negotiations for settlement or compromise. If one or more Products sold hereunder is subject to such a claim, Seller may, at its sole expense and option, procure for Buyer the right to continue using the Products, replace or modify the Products so as to render them non-infringing, or offer to accept return of the Products and refund the purchase price less a reasonable allowance for depreciation. Seller has no obligation or liability for any claim of infringement: (i) arising from information provided by Buyer; or (ii) directed to any Products provided hereunder for which the designs are specified in whole or part by Buyer; or (iii) resulting from the modification, combination or use in a system of any Products provided hereunder. The foregoing provisions of this Section constitute Seller's sole and exclusive liability and Buyer's sole and exclusive remedy for such claims of infringement of Intellectual Property Rights.
- 20. Governing Law.** These Terms and the sale and delivery of all Products are deemed to have taken place in, and shall be governed and construed in accordance with, the laws of the State of Ohio, as applicable to contracts executed and wholly performed therein and without regard to conflicts of laws principles. Buyer irrevocably agrees and consents to the exclusive

jurisdiction and venue of the courts of Cuyahoga County, Ohio with respect to any dispute, controversy or claim arising out of or relating to the sale and delivery of the Products.

- 21. Entire Agreement.** These Terms, along with the terms set forth in the main body of any Quote, forms the entire agreement between the Buyer and Seller and constitutes the final, complete and exclusive expression of the terms of sale. In the event of a conflict between any term set forth in the main body of a Quote and these Terms, the terms set forth in the main body of the Quote shall prevail. All prior or contemporaneous written or oral agreements or negotiations with respect to the subject matter shall have no effect. These Terms may not be modified unless in writing and signed by an authorized representative of Seller.
- 22. Compliance with Laws.** Buyer agrees to comply with all applicable laws, regulations, and industry and professional standards, including those of the United States of America, and the country or countries in which Buyer may operate, including without limitation the U.S. Foreign Corrupt Practices Act ("FCPA"), the U.S. Anti-Kickback Act ("Anti-Kickback Act"), U.S. and E.U. export control and sanctions laws ("Export Laws"), the U.S. Food Drug and Cosmetic Act ("FDCA"), and the rules and regulations promulgated by the U.S. Food and Drug Administration ("FDA"), each as currently amended. Buyer agrees to indemnify, defend, and hold harmless Seller from the consequences of any violation of such laws, regulations and standards by Buyer, its employees or agents. Buyer acknowledges that it is familiar with all applicable provisions of the FCPA, the Anti-Kickback Act, Export Laws, the FDCA and the FDA and certifies that Buyer will adhere to the requirements thereof and not take any action that would make Seller violate such requirements. Buyer represents and agrees that Buyer will not make any payment or give anything of value, directly or indirectly, to any governmental official, foreign political party or official thereof, candidate for foreign political office, or commercial entity or person, for any improper purpose, including the purpose of influencing such person to purchase Products or otherwise benefit the business of Seller. Buyer further represents and agrees that it will not receive, use, service, transfer or ship any Product from Seller in a manner or for a purpose that violates Export Laws or would cause Seller to be in violation of Export Laws.

Parker's Motion & Control Product Groups

At Parker, we're guided by a relentless drive to help our customers become more productive and achieve higher levels of profitability by engineering the best systems for their requirements. It means looking at customer applications from many angles to find new ways to create value. Whatever the motion and control technology need, Parker has the experience, breadth of product and global reach to consistently deliver. No company knows more about motion and control technology than Parker. For further info call 1 800 G-Parker (1 800 272 7537).



Aerospace

Key Markets

Aftermarket services
Commercial transports
Engines
General & business aviation
Helicopters
Launch vehicles
Military aircraft
Missiles
Power generation
Regional transports
Unmanned aerial vehicles

Key Products

Control systems & actuation products
Engine systems & components
Fluid conveyance systems & components
Fluid metering, delivery & atomization devices
Fuel systems & components
Fuel tank inerting systems
Hydraulic systems & components
Thermal management
Wheels & brakes



Automation

Key Markets

Alternative energy
Conveyor & material handling
Factory automation
Food & beverage
Life sciences & medical
Machine tools
Packaging machinery
Paper machinery
Plastics machinery
Primary metals
Safety & security
Semiconductor & electronics
Transportation & automotive

Key Products

AC/DC drives & systems
Air preparation
Electric actuators, gantry robots & slides
Human machine interfaces
Inverters
Manifolds
Miniature fluidics
Pneumatic actuators & grippers
Pneumatic valves & controls
Rotary actuators
Stepper motors, servo motors, drives & controls
Structural extrusions
Vacuum generators, cups & sensors



Climate & Industrial Controls

Key Markets

Agriculture
Air conditioning
Construction Machinery
Food & beverage
Industrial machinery
Life sciences
Oil & gas
Precision cooling
Process
Refrigeration
Transportation

Key Products

Accumulators
Advanced actuators
CO₂ controls
Electronic controllers
Filter driers
Hand shut-off valves
Heat exchangers
Hose & fittings
Pressure regulating valves
Refrigerant distributors
Safety relief valves
Smart pumps
Solenoid valves
Thermostatic expansion valves



Filtration

Key Markets

Aerospace
Food & beverage
Industrial plant & equipment
Life sciences
Marine
Mobile equipment
Oil & gas
Power generation & renewable energy
Process
Transportation
Water Purification

Key Products

Analytical gas generators
Compressed air filters & dryers
Engine air, coolant, fuel & oil filtration systems
Fluid condition monitoring systems
Hydraulic & lubrication filters
Hydrogen, nitrogen & zero air generators
Instrumentation filters
Membrane & fiber filters
Microfiltration
Sterile air filtration
Water desalination & purification filters & systems



Fluid Connectors

Key Markets

Aerial lift
Agriculture
Bulk chemical handling
Construction machinery
Food & beverage
Fuel & gas delivery
Industrial machinery
Life sciences
Marine
Mining
Mobile
Oil & gas
Renewable energy
Transportation

Key Products

Check valves
Connectors for low pressure fluid conveyance
Deep sea umbilicals
Diagnostic equipment
Hose couplings
Industrial hose
Mooring systems & power cables
PTFE hose & tubing
Quick couplings
Rubber & thermoplastic hose
Tube fittings & adapters
Tubing & plastic fittings



Hydraulics

Key Markets

Aerial lift
Agriculture
Alternative energy
Construction machinery
Forestry
Industrial machinery
Machine tools
Marine
Material handling
Mining
Oil & gas
Power generation
Refuse vehicles
Renewable energy
Truck hydraulics
Turf equipment

Key Products

Accumulators
Cartridge valves
Electrohydraulic actuators
Human machine interfaces
Hybrid drives
Hydraulic cylinders
Hydraulic motors & pumps
Hydraulic systems
Hydraulic valves & controls
Hydrostatic steering
Integrated hydraulic circuits
Power take-offs
Power units
Rotary actuators
Sensors



Instrumentation

Key Markets

Alternative fuels
Biopharmaceuticals
Chemical & refining
Food & beverage
Marine & shipbuilding
Medical & dental
Microelectronics
Nuclear Power
Offshore oil exploration
Oil & gas
Pharmaceuticals
Power generation
Pulp & paper
Steel
Water/wastewater

Key Products

Analytical Instruments
Analytical sample conditioning products & systems
Chemical injection fittings & valves
Fluoropolymer chemical delivery fittings, valves & pumps
High purity gas delivery fittings, valves, regulators & digital flow controllers
Industrial mass flow meters/controllers
Permanent no-weld tube fittings
Precision industrial regulators & flow controllers
Process control double block & bleeds
Process control fittings, valves, regulators & manifold valves



Seal

Key Markets

Aerospace
Chemical processing
Consumer
Fluid power
General industrial
Information technology
Life sciences
Microelectronics
Military
Oil & gas
Power generation
Renewable energy
Telecommunications
Transportation

Key Products

Dynamic seals
Elastomeric o-rings
Electro-medical instrument design & assembly
EMI shielding
Extruded & precision-cut, fabricated elastomeric seals
High temperature metal seals
Homogeneous & inserted elastomeric shapes
Medical device fabrication & assembly
Metal & plastic retained composite seals
Shielded optical windows
Silicone tubing & extrusions
Thermal management
Vibration dampening



ENGINEERING YOUR SUCCESS.

Parker Fluid Connectors Group

North American Divisions & Distribution Service Centers

Your complete source for quality tube fittings, hose & hose fittings, brass & composite fittings, quick-disconnect couplings, valves and assembly tools, locally available from a worldwide network of authorized distributors.

Fittings:

Available in inch and metric sizes covering SAE, BSP, DIN, GAZ, JIS and ISO thread configurations, manufactured from steel, stainless steel, brass, aluminum, nylon and thermoplastic.

Hose, Tubing and Bundles:

Available in a wide variety of sizes and materials including rubber, wire-reinforced, thermoplastic, hybrid and custom compounds.

Worldwide Availability:

Parker operates Fluid Connectors manufacturing locations and sales offices throughout North America, South America, Europe and Asia-Pacific.

For information, call toll free...

1-800-C-PARKER
(1-800-272-7537)

North American Divisions

Fluid System Connectors Division

Otsego, MI
phone 269 692 6555
fax 269 694 4614

Engineering Support:
fscapps@parker.com

Customer Support:
fscsales@parker.com

Quote Support:
fscquote@parker.com

Hose Products Division

Wickliffe, OH
phone 440 943 5700
fax 440 943 3129

Parfex Division

Ravenna, OH
phone 330 296 2871
fax 330 296 8433

Quick Coupling Division

Minneapolis, MN
phone 763 544 7781
fax 763 544 3418

Tube Fittings Division

Columbus, OH
phone 614 279 7070
fax 614 279 7685

Distribution Service Centers

Buena Park, CA

phone 714 522 8840
fax 714 994 1183

Conyers, GA

phone 770 929 0330
fax 770 929 0230

Louisville, KY

phone 502 937 1322
fax 502 937 4180

Portland, OR

phone 503 283 1020
fax 503 283 2201

Toledo, OH

phone 419 878 7000
fax 419 878 7001
fax 419 878 7420
(FCG Kit Operations)

Canada

Milton, ONT

phone 905 693 3000
fax 905 876 1958

Mexico

Toluca, MEX

phone (52) 722 2754 200
fax (52) 722 2722 168

